



# ALLIED GROUP

of Industries

Manufacturer and Exporter of Dental & Surgical Instruments.



## DENTAL INSTRUMENTS CATALOGUE



**Allied Group of Industries** is a leading manufacturer and exporter of all kinds of single use and reusable Surgical & Dental instruments to worldwide. Our manufacturing unit is located at Sialkot (Pakistan), a world's renowned city for the manufacturing of Surgical & Dental Instruments. This is our family business, so we have worked hard to build our reputation in this evolving industry and our satisfied customers are our strength.

Our products are manufactured by using the best quality stainless steel as **AISI, ASTM** and **DIN** standard's recommended which is imported from **Germany, Japan** and **France**. All of the Surgical & Dental Instruments supplied by us are **ISO 9001:2015, ISO 13485:2012** and **CE** marked certified in accordance with the Medical Devices Directive. The key to our success is our quality assurance. We use the right material for the right products. We are also **OEM (Original Equipment Manufacturer)** and provide customise packaging to our customers.

We have vast range of different instruments available in our stock ready to be shipped for fast delivery to our valuable customers. By using the traditional craftsmanship and latest precision technologies, we are able to manufacture the instruments that are compatible and compete with the highest standards and quality of international markets. **Allied Group of Industries** is strongly determined to provide a dedicated service to customers that is built on foundations of quality and cost effectiveness.

**Allied Group of Industries** prices are very competitive and very flexible with customers provide maximum co-operation. Our company's motto is to keep customers satisfy because your satisfaction is our business.

### Our Mission At Allied Group of Industries

1. To provide our customers with outstanding customer support and provide premium quality Surgical & Dental instruments at the best and competitive prices.
2. To provide our customers with friendly support, easy-to-use ordering system.
3. To provide our customers with the latest products available.

### Our Policy At Allied Group of Industries

1. To be the market leader in supplying the best and premium quality Surgical & Dental instruments at highly competitive and affordable prices.
2. Fully understand the requirements of our respected customers and satisfy them.
3. Strongly follow the policy "**Customer First**" and "**Quality First**"
4. To continuously develop our technical expertise on the basis of technology, customer's feedback and quality workforce

5. To form strategic joint ventures and distribution networks within the industry around the globe and to fulfill our social, ethical and industrial obligations in the most effective and efficient manner.

#### **Our Strategy At Allied Group of Industries**

- 1) It is our utmost priority to serve our valuable customers with fair dealing, honesty, sincerity, truth, trustworthy relationship and cooperation.
- 2) We always cordially welcome our valuable customer's opinions, suggestions and recommendations.
- 3) We give replacement against defective goods, if the malfunction occurred at our end.
- 4) The stainless steel used in the production of purchase order is exactly the same as per approved samples.
- 5) Normally for cutting instruments like Scissors, Knives etc. we use (AISI 420 Grade) premium quality stainless steel.
- 6) For non-cutting instruments like Forceps, Tweezers, Impression Trays etc. we use (AISI 410 & AISI 304 Grade) premium quality Stainless Steel.
- 7) Moreover, we can use also the material as per our customer's requirements and demand.

If you would like to get our price list, interested to see our samples for quality assessment, would like to be our distributor or want to get more information about our premium quality instruments, please feel free to contact us for any information.

Thank you very much for your precious time and looking forward to get business from you.

**Best Regards**

**Director**

**Allied Group of Industries**

ALLIED GROUP  
of Industries

## Quality Management System

The quality policy is the main guiding principles that provide the focus of quality to the whole organization and improve the effectiveness of the quality management system.

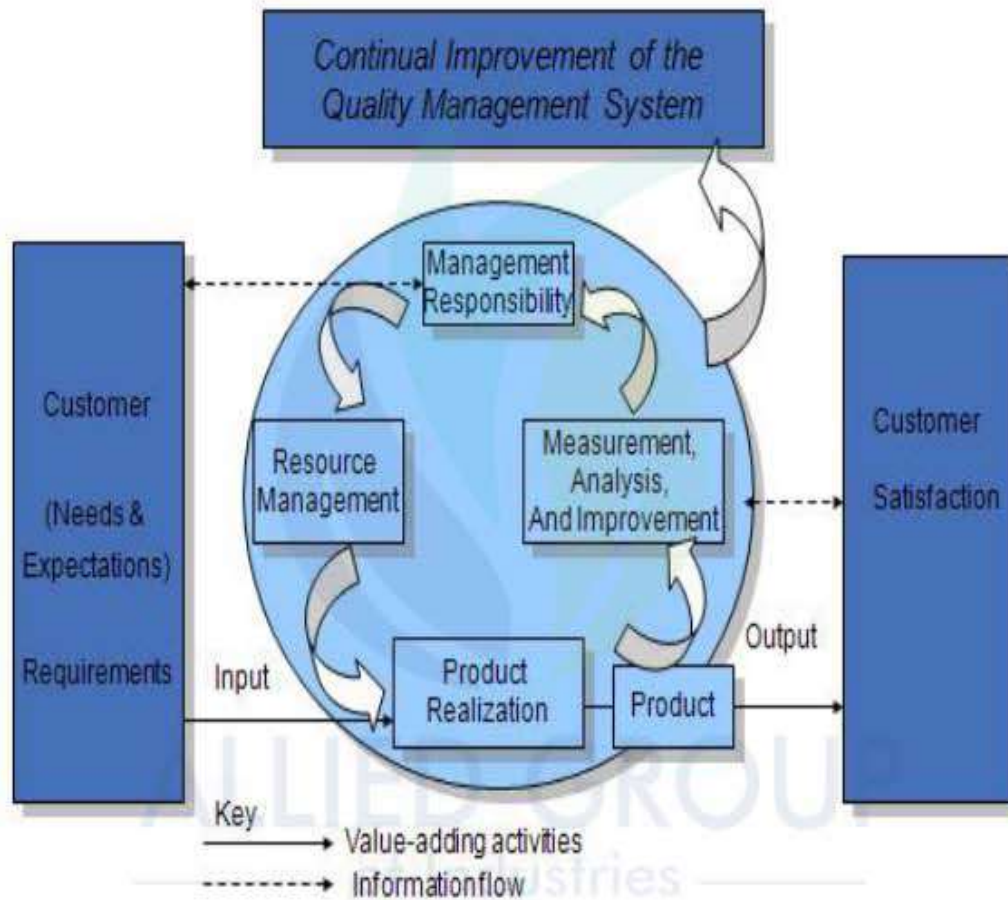

**Quality Begins With People Who Care**

## PROCESS FLOW CHART



## Manufacturing Capabilities Of Allied Group of Industries

All of our production departments are well equipped with the latest machinery which is imported from **Germany** and **England** and are well-staffed with the expert technicians.

### Raw Material Department

**Allied Group of Industries** always purchases best quality stainless steel raw material from steel suppliers or import directly from **Japan, France** and **Germany** when need to do. Different grades of stainless steel for example (**303, 304, 410, 420 & 440**) are used in the production of our Surgical & Dental Instruments.

At Allied Group of Industries, we believe that quality can only be achieved through quality raw material. As such, the best quality raw-materials (Stainless Steel Strips, Round Bars, Stainless Steel Coils and Stainless Steel Tubes) are purchased and are subjected to composition and hardness testing through our in-house laboratory in order to ensure that only the best materials are passed on to production departments.

### ASTM Standards

**Allied Group of Industries** fully follows and complies with the international **ASTM Standards** during the manufacturing of instruments. Below mentioned are the references and lists of the standards that we follow:-

- 1) **Allied Group of Industries** acquires premium quality stainless steel for the manufacturing of Surgical & Dental Instruments as per **ASTM Standard F899-95** and **ISO 7153**.
- 2) Descaling and cleaning of stainless steel in conformity to **ASTM Standard A380-99**.
- 3) Passivation of Surgical & Dental Instruments in conformity to **ASTM Standard B967-05**.
- 4) Corrosion of Surgical & Dental Instruments in conformity to **ASTM Standard F1089-02**.
- 5) Electro-polishing of Surgical & Dental Instruments in conformity to **ASTM Standard B912-02**.
- 6) As different instruments are manufactured with different grades of stainless steel. We mostly use the stainless steel type **AISI-303, AISI-304, AISI-410, AISI-420, and AISI 440** series with defined specifications as per customer's requirements. Therefore, in order to select the proper grade of stainless steel, various processes are followed according to the guidelines and conformity of **ASTM Standards**.

### **Forging Department**

**Allied Group of Industries** has its own forging section where forgings are made through Drop Hammer process by seasoned operators using dyes made of the best quality imported D-2 Steel. Forging is done by keeping in mind that the geometry of this process is a starting point and does not on any way limit your design freedom.

### **Milling Department**

Milling is used in the Surgical & Dental instruments industry, defined as the process of cutting, shaping and finishing of an instrument. It is the process that includes turning, welding and fringing. At **Allied Group of Industries** we use the best milling technology which involves cutting away pieces of metal to create dovetails, threads, bevels, slots and ridges.

### **Grinding: (Filing & Setting)**

In order to give a final shape to the instrument, our highly skilled craftsman use filing and grinding processes which removes the material from the instrument by abrasion. Then the instrument is keenly observed and set to perform perfect.

### **Hardness Test (Heat Treatment)**

For Surgical & Dental instruments, the term harness refers to the resistance to bending, scratching, abrasion or cutting. We have in-house Heat Treatment Department equipped with top quality Vacuum Furnace where qualified staff and engineers are engaged in treating the instruments in order to add strength to the steel and perfect the metallurgical composition for further processes. 50-55 hardness rating is applied to each instrument during the heat treatment process in order to increase the strength of instruments.

### **Polishing Department**

The Electro-polishing Department is manned by seasoned workmen using imported chemicals and best quality grinding wheels to ensure the best quality finish. In this department at **Allied Group of Industries**, the instruments are given final finish which includes mirror, satin or matt finishes. The finish is per customer's requirements.

### **Tungsten Carbide Department**

**Allied Group of Industries'** tungsten carbide department is installed with the best quality imported machinery being manned by the exceptionally well trained experts using the German Technology. We use German tungsten carbide tips for our instruments.

### **Coating Department**

Our coating department is capable of providing gold plated instruments as well as powder coated instruments depending upon the requirements of the instrument or the customer. Best quality coating related raw materials are used so that no compromise can be made on quality. Furthermore, each coating is inspected for quality before any instrument is passed on to the next department.

### **Passivation Department**

We use high quality imported chemicals in our Passivation Department. Every instrument is boil test and passivate for 24 hours before move to the next department. If need arises, the instruments are re-passivated so as to eliminate any chances of rusting or corrosion during the life of the instrument. Our instruments are rust-free for life though we give guarantee for five years.

### **Sandblasting Department**

For sandblasting of our instruments, we use the machines as well as the best quality sandblasting material, which are operated by skilled & well trained operators.

### **Stamping/Etching**

We use permanent and long life high quality laser etching which produces a wide variety of text and graphic images including our customer's logo with very detailed and fine image quality.

### **Quality Control Department**

Our quality control department is involved at all of the processes of manufacturing but before the instrument goes to the packing department, its quality and function is thoroughly checked by our qualified engineers.

### **Labeling and Packing**

Each instrument is initially packed in a poly bag to prevent scratches and then packed in the middle box. Middle boxes are then packed in the carton. The middle boxes are labeled which includes the article number, types and sizes of instruments. We can also arrange packaging and labeling according to the customers demand.

### **Warehouse/Stock Room**

After the instruments are packed and labeled, cartons are then move to our in-house warehouse where the complete record of shipments are maintained by our qualified warehouse management.



## Terms and Conditions Of Business

### Company's Agreement

Allied Group of Industries believes in the highest moral values and business ethics. Once a contract is made with a customer, we strongly aim at following it in its true spirit regarding the quality of product, packing, delivery time or any other particular need of the importer.

### Prices

Our prices are stable for one year, after which they may be subject to a change depending upon general price increase of stainless steel. Instruments prices are revised according to the price of raw material and craftsmanship at the end of company's financial year.

### Minimum Orders

We require a minimum order of US\$ 500.00 to process a delivery.

### Payment Terms

With new customers, we require an advance payment of 100% for first six months. However, credit terms can be arranged according to the importers requirement after 6 months.

### Freight & Shipping

Allied Group of Industries provides different methods of delivery as per customers demand:

- 1) By Air
- 2) By Sea
- 3) By Courier

Freight and shipping charges may be added to the invoice depending upon the nature of delivery unless otherwise stated by the importer. We deliver both C&F and FOB shipments.

### Returns Policy

A great deal of effort is made on packing your order with great care. Please inspect the instruments thoroughly for any loss or damage immediately upon delivery of products and file claim if products are found damaged. Concealed loss or damage must be reported within 5 days upon receipt.

### Returns and Technical Support

No returns are accepted without prior notices. Please contact our customer service team to obtain your invoice number. We reserve the right to examine returned goods before issuing credit. Returns must be made as soon as possible. Our technical team will carry out all repairs quickly and reliably.

## CARE, HANDLING AND STERILISATION OF INSTRUMENTS

### Allied Group of Industries Approved Sterilisation Methods

We recommend steam autoclave and ethylene oxide (ETO) sterilisation methods. Steam autoclave is highly efficient method of sterilisation which will not dull sharpness of instruments. If steam autoclave and ethylene oxide methods are not available, dry heat and chemical vapour methods are also recommended. We don't approve chemical sterilisation methods. These methods destroy instruments quickly and if used will eventually invalidate the warranty of your instruments.

### Sterilisation Advice

Instruments should be dry before sterilising and in the open position when sterilised. Instruments trays should never be overloaded. Sterilising units must be cleaned and functioning properly. Autoclaves have high levels of moisture can be damaging if not in good working order. Purified, distilled water must be used in autoclave sterilisation units. We don't recommend using tap water. It contains minerals which can cause corrosion and discolouration of instruments. Take out the instruments from the autoclave immediately after cooling when the sterilisation cycle is completed. Ensure that all tips and joints of the instruments are moisture free. Moisture may cause corrosion. Before storage, instruments should be properly lubricated with silicon based lubricant.

### Cleaning of Instruments

Always clean the instruments thoroughly in order to enhance the life span of your instruments. Bulk debris should be removed immediately after use. We recommend Enzymatic Cleaning solution in an ultrasonic cleaner to clean the instruments. Ultrasonic solution must be changed on daily basis. Instruments with hinge must be cleaned in an open position. Oxidation and discoloration may occur if instruments are not thoroughly cleaned. Always use disinfectants and detergents which are suitable for use with Surgical & Dental instruments. With regards to concentration and length of exposure, detergent manufacturer's instructions should be followed strictly. Tap water should be avoided during the cleaning of instruments. It contains minerals which can cause corrosion and discolouration of instruments. Tap water can also neutralise the rust inhibiting and lubricating solution.

We recommend the use of purified, distilled water in ultrasonic cleaning units. It is also recommended to use non-rinse ultrasonic solution that contains both lubricant and rust inhibitor prior to sterilisation and follow the manufacturer's exact solution measurement. Never leave the instruments in the ultrasonic solution after the cycle is finished. Instruments should be removed and dried immediately.

### Lubrication of Instruments

Instruments must be lubricated regularly to increase the life time of instruments. It should be carried out daily or at least on a weekly basis. Prior to sterilisation, instruments must be lubricated. Lubricants designed specifically for precision hinged instruments should be used. Make sure to use lubricant that is well-suited with the operating temperature of your dry heat unit if dry heat steriliser is being used.

### Sharpening of Instruments

Regular sharpening of instruments for example cutters will enhance their service life and increase their ability to cut more effectively and efficiently. **Allied Group of Industries** recommends frequency of sharpening the cutters depends on how frequently you use them and also the diameters and type of wires in which the cutter is being used frequently. Cutters must be assessed regularly if sharpening is required.

### Corrosion

All of the instruments manufactured by **Allied Group of Industries** are highly resistant to corrosion. Following care recommendations and maintenance tips can be followed to further prevent corrosion problems. Occasionally, discolouration of instruments may not be corrosion. Sometimes organic materials that are deposited on the instruments during use can give the appearance of corrosion or can be mistaken for rust.

- 1) An orange-brown stain is normally a phosphate layer caused by water sources, sterilisation solutions or cleaning detergents.
- 2) A black stain is normally an acidic reaction caused by detergents.
- 3) A dark brown stain is usually caused by dried blood residues.
- 4) A blue-black stain is usually plating caused by autoclave cleaning materials.

Corroded instruments should never be mixed with non-corroded instruments as it may multiply the process of oxidation. We strongly recommend discarding or replacing the corroded instruments immediately.

### Prevention of Corrosion

Corrosion can be an issue with any stainless steel instrument. Stainless steel requires oxygen to form a chromium oxide surface layer, which prevents it from corrosion. Bonding agents, organic residue and water droplets left on the instruments prevents oxygen to come in contact with the surface of the instrument and forming this protective layer.

### Allied Group of Industries Recommends The Following Steps To Prevent Corrosion

- 1) Prior to the sterilisation of instruments, all residual matter must be cleaned thoroughly.
- 2) Instruments must be sterilised in open position.
- 3) Instruments must be properly air or towel dried. Specifically take care of the joint areas and hinges.
- 4) Corroded instruments should never be sterilised with non-corroded instruments as it may permanently transfer the iron oxide on the corroded instruments to the non-corroded instruments.

### Allied Group of Industries Final Recommendations

- 1) All RE-USABLE instruments are delivered in NON-STERILE condition and must be cleaned, lubricated and sterilised before every use.
- 2) All instruments should be disinfected and cleaned immediately after use with disposable cloth/paper/ wipes etc.
- 3) If the instruments come into contact with blood, tissue, physiological saline or other foreign substances, they should be rinsed with warm (not hot) water before the substance dries up on the instruments.
- 4) We recommend cleaning solutions and rinse with pH7.0.
- 5) Ultrasonic cleaning is recommended.
- 6) For effectiveness, first clean any residue off the instruments before placing them in ultrasonic cleaner.
- 7) After cleaning, all instruments should be dried immediately.
- 8) Treat all instruments with oil which is considered as being physiologically safe (paraffin oil), especially their ends, ratchets, and moveable parts.
- 9) Instruments can be disinfected in Thermal Washer disinfectors.
- 10) For the disinfection and cleaning of Titanium and Aluminium Instruments, only use the substances that are particularly suggested for Titanium and Aluminium Instruments.
- 11) For instruments manufactured with autoclavable plastic, place them in the middle of chamber to avoid the overheating of plastic and not along the walls of chamber. We recommend to sterilise these instruments by putting them in "Self Sealing Sterilisation Pouches".
- 12) Do not leave instruments in cleaning or disinfecting solutions for a long time (over night or weekend) otherwise instruments can be damaged.
- 13) All instruments should be visually inspected for damage or breakage.
- 14) It is the user's responsibility to take proper care of the instruments.
- 15) We recommend laying down all instruments in their primary packaging.
- 16) Vacuum autoclave (steam) is performed at the temperature of 134 °C.
- 17) If instruments are dry heat (hot-air) sterilised, the temperature should be between 180 °C to 190 °C.

- 18) Corroded instruments should be discarded immediately.
- 19) The instructions of the autoclave manufacturer must be observed and followed always.
- 20) Instruments must be stored in dry, clean and humidity free environment without direct solar radiation.
- 21) Protect pointed tips of instruments with cloth, gauze or a special protection tube available from Allied Group of Industries.

### Maintenance of Instruments

Allied Surgical always recommend to follow proper handling, care and sterilisation methods in order to increase the life span of your instruments in order to make sure they perform the best that they can.

| Note: Always Use The Cleaning & Disinfection Solutions/Substances That Are Particularly Suggested For Specific Type & Category Of Instruments And Follow The Manufacturer Instructions. |            |                  |                               |                                 |                         |                        |                        |
|---|------------|------------------|-------------------------------|---------------------------------|-------------------------|------------------------|------------------------|
| Type Of Instruments   | Ultrasonic | Automatic Washer | Cold Disinfection Water Based | Cold Disinfection Alcohol Based | Autoclave 121 °C Saliva | Autoclave 134 °C Blood | Dry Heat Sterilisation |
| Stainless Steel / Titanium  | ✓          | ✓                | ✓                             | ✓                               | ✓                       | ✓                      | ✓                      |
| Non Anodized Aluminium & Titanium Coating   | ✓          | ✓                | ✓                             | ✓                               | ✓                       | ✓                      | ✓                      |
| Silicon & Autoclave Plastic   | ✓          | ✓                | ✓                             | ✓                               | ✓                       | ✓                      | ✓                      |
| Anodized Aluminium, Silver & Chrome Plated  | ✗          | ✗                | ✗                             | ✓                               | ✓                       | ✓                      | ✗                      |
| Brass & Polycarbonates  | ✗          | ✗                | ✗                             | ✓                               | ✓                       | ✗                      | ✗                      |
| Diamond Coated  | ✗          | ✗                | ✗                             | ✓                               | ✗                       | ✗                      | ✗                      |
| Non Autoclave Plastic   | ✗          | ✗                | ✓                             | ✗                               | ✗                       | ✗                      | ✗                      |

**01**

**EXTRACTING FORCEPS**

**Page # 01 - 28**

**02**

**ROOT ELEVATORS**

**Page # 29 - 48**

**03**

**DIAGNOSTIC, PROBES, SCALERS, FILLING  
& LABORATORY INSTRUMENTS**

**Page # 49 - 98**

**04**

**MAXILLOFACIAL SURGERY  
INSTRUMENTS**

**Page # 99 - 124**

**05**

**ORTHODONTIC INSTRUMENTS  
& PLIERS**

**Page # 125 - 144**

**06**

**DENTAL IMPLANT INSTRUMENTS  
& Impression Tray**

**Page # 145 - 182**

**07**

**HOLLOWWARE**

**Page # 183 - 191**

# EXTRACTING FORCEPS

## Handle Selection For Extracting Forceps

Dear Valued Buyers if any Universal Fig. No. of Extracting Forceps not Found in our Catalogue you Can Refer the Fig. No. From These Diagram.

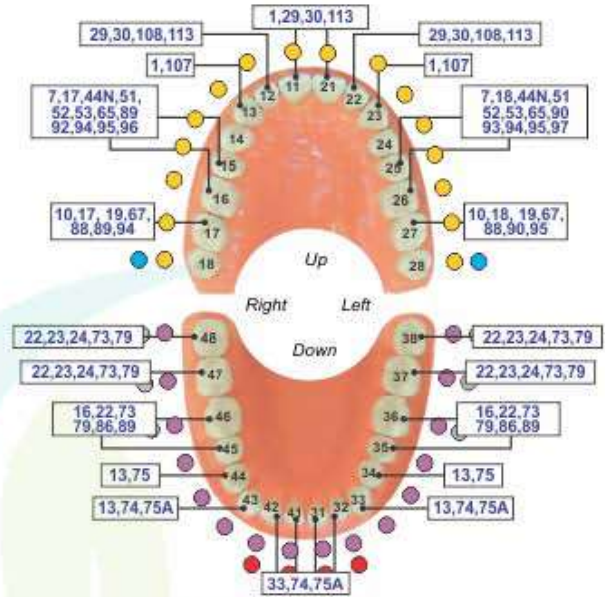
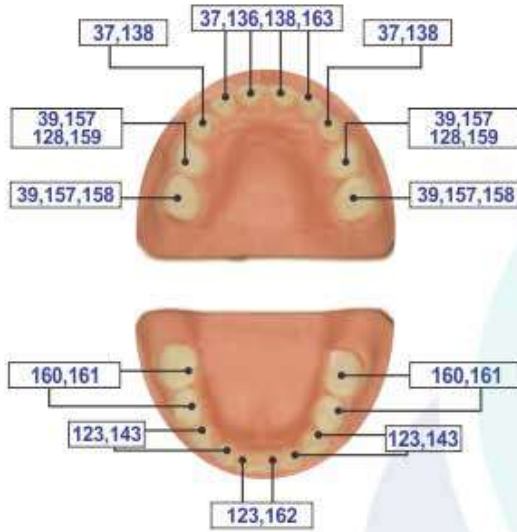

Dear Valued Buyers these are our Handle Styles



## EXTRACTING FORCEPS (English Pattern)

- Щипцы экстракционные (английская форма)
- Daviers (Forme Anglaise)
- Zahnzangen (Englische Form)
- Щипці екстракційні (англійська форма)
- Forceps de Extracción (Forme Inglesa)
- استخراج الملقط (نمط اللغة الإنجليزية)

Function: To remove teeth from bony socket



**AG1-001**  
Fig. 1  
Upper Centrals  
and Canines



**AG1-002**  
Fig. 2  
Upper Laterals  
and Canines



**AG1-003**  
Fig. 4  
Lower Incisors  
and Canines



**AG1-004**  
Fig. 7  
Upper Premolars



**AG1-005**  
Fig. 8  
Lower Premolars



**AG1-006**  
Fig. 13  
Lower Premolars



**AG1-007**  
Fig. 17  
Upper Molars,  
Right



**AG1-008**  
Fig. 18  
Upper Molars, Left



**AG1-009**  
Fig. 21  
Lower Molar



**AG1-010**  
Fig. 22  
Lower Molar



Straight extracting forceps for upper incisors and canines



Straight extracting forceps for upper incisors and canines



Straight extracting forceps for upper incisors and canines



## EXTRACTING FORCEPS (English Pattern)

- Щипцы экстракционные (английская форма)
- Щипці екстракційні (англійська форма)
- Daviers (Forme Anglaise)
- Forceps de Extracción (Forme Inglesa)
- Zahnzangen (Englische Form)
- استخراج الملقط (نمط اللغة الإنجليزية)

Function: To remove teeth from bony socket



**AG1-011**  
**# 18A**  
upper molars



**AG1-012**  
**# 19**  
upper third molars



**AG1-013**  
**# 20**  
lower third molar



**AG1-014**  
**# 24**  
lower molar, right



**AG1-015**  
**# 29**  
upper roots



**AG1-016**  
**# 30**  
Upper Roots



**AG1-017**  
**# 33**  
lower roots



**AG1-018**  
**# 33A**  
Lower Roots



**AG1-019**  
**# 33M**  
Lower roots  
with long beak



**AG1-020**  
**# 46L**



**AG1-021**  
**# 51**  
Upper Roots



**AG1-022**  
**# 51A**  
Upper Roots



Straight extracting forceps for upper incisors and canines



Straight extracting forceps for upper incisors and canines



Straight extracting forceps for upper incisors and canines

## EXTRACTING FORCEPS (English Pattern)

- Щипцы экстракционные (английская форма)
- Щипці екстракційні (англійська форма)
- Daviers (Forme Anglaise)
- Forceps de Extracción (Forme Inglesa)
- Zahnzangen (Englische Form)
- استخراج الملقط (نمط اللغة الإنجليزية)

Function: To remove teeth from bony socket

### WISDOM EXTRACTING FORCEPS



**AG1-023**  
**Routerier**  
**(# 22 ½ L)**  
lower molars and  
wisdoms, left



**AG1-024**  
**Routerier**  
**(# 22 ½ R)**  
lower molars and  
wisdoms, right



*Routerier extracting forceps for lower molars  
and third molars, right*



**AG1-025**  
**Routerier**  
**(# 33 ½ L)**  
lower molar and  
wisdom roots, left



**AG1-026**  
**Routerier**  
**(# 33 ½ R)**  
lower molar and  
wisdom roots, right



**AG1-027**  
**Fig. 186L**  
lower molars



**AG1-028**  
**Fig. 186R**  
lower molars



**AG1-029**  
**# 51AL**



**AG1-030**  
**# 67**  
Upper Third Molars



**AG1-031**  
**# 67A**  
Upper Third Molars



**AG1-032**  
**# 79**  
Lower Third Molars



*Angled extracting forceps for upper roots*

## EXTRACTING FORCEPS (English Pattern)

- Щипцы экстракционные (английская форма)
- Щипці екстракційні (англійська форма)
- Forceps de Extracción (Forme Inglesa)
- استخراج الملقط (نمط اللغة الإنجليزية)
- Daviers (Forme Anglaise)
- Forcets de Extracción (Forme Inglesa)
- Zahnzangen (Englische Form)



**AG1-033**  
**# 73**  
Lower Molars

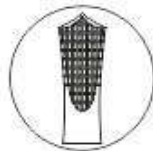

**AG1-034**  
**# 73 A**  
lower molars

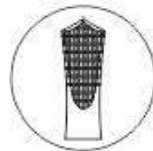

**AG1-035**  
**# 73 S**



**AG1-036**  
**# 74**  
Lower Roots



**AG1-037**  
**# 74N**  
Lower Roots



**AG1-038**  
**# 75**  
Lower Premolars



**AG1-039**  
**# 86A**  
Lower Molars



**AG1-040**  
**# 86B**  
lower molars



**AG1-041**  
**# 86C**  
lower molars



**AG1-042**  
**# 87**  
Lower Molars



**AG1-043**  
**# 89**  
Upper Molars,  
Right



**AG1-044**  
**# 90**  
Upper Molars,  
Left



*Straight extracting forceps for upper incisors and canines*



*Straight extracting forceps for upper incisors and canines*



*Straight extracting forceps for upper incisors and canines*

## EXTRACTING FORCEPS (English Pattern)

- Щипцы экстракционные (английская форма)
- Daviers (Forme Anglaise)
- Zahnzangen (Englische Form)
- Щипці екстракційні (англійська форма)
- Forceps de Extracción (Forme Inglesa)
- استخراج الملقط (نمط اللغة الإنجليزية)

### A-TRAUMATIC EXTRACTION

Improved tapered beaks for complete root contact. Cross serrations. Deep Gripe Extracting Forceps



- No Fracture
- No Tissue Damage
- Extraction With Easy



Thin Tip

**AG1-045**  
# 34

Upper incisors and  
premolars  
deep-gripping



Wide Tip

**AG1-046**  
# 34A

Upper centrals / cains  
deep-gripping



Thin Tip

**AG1-047**  
Fig. 35

upper permolars  
deep-gripping



Wide Tip

**AG1-048**  
# 35A

Upper incisors and  
premolars  
deep-gripping



Thin Tip

**AG1-049**  
# 36

Lower premolars  
deep-gripping



Wide Tip

**AG1-050**  
# 36A

Lower premolars  
deep-gripping



**AG1-051**  
# 336

lower permolars  
deep-gripping



**AG1-052**  
F-7C

lower molar



**AG1-053**  
# 9

Apex Forceps Lower Universal  
Deep Root Pick



**AG1-054**  
# 79N

Lower third molars  
deep-gripping



**AG1-055**  
# 79

Lower Third Molars



#### Function:

Extraction forceps are used to further loosen teeth by rotational and tilting movements and finally to extract the teeth in combination with a fulcrum.

## EXTRACTING FORCEPS (English Pattern)

- Щипцы экстракционные (английская форма)
- Щипці екстракційні (англійська форма)
- Daviers (Forme Anglaise)
- Forceps de Extracción (Forme Inglesa)
- Zahnzangen (Englische Form)
- استخراج الملقط (نمط اللغة الإنجليزية)

### DEEP ROOT PICK FORCEPS



**AG1-056**  
**# 146**  
Apex Forceps Lower Root  
Deep Root Pick



**AG1-057**  
**# 153**  
Apex Forceps Upper Root  
Deep Root Pick



**AG1-058**  
**# 149**  
Apex Forceps Upper Root  
Deep Root Pick



**AG1-061**  
Fig. 44



**AG1-060**  
Fig. 44Z



**AG1-059**  
Fig. 45Z



**AG1-062**  
**# 46XL**  
Apex Forceps Lower Root  
Deep Root Pick



**AG1-063**  
**# 67**  
Upper Third Molars



**AG1-064**  
**# 67A**  
Upper Third Molars



**AG1-065**  
**# 67N**  
Lower third molars  
deep-gripping



**AG1-066**  
**# 331**  
upper roots  
deep-gripping



forceps for upper incisors, premolars and roots



## EXTRACTING FORCEPS (English Pattern)

- Щипцы экстракционные (английская форма)
- Daviers (Forme Anglaise)
- Zahnzangen (Englische Form)
- Щипці екстракційні (англійська форма)
- Forceps de Extracción (Forme Inglesa)
- استخراج الملقط (نمط اللغة الإنجليزية)



Fig. 1  
upper  
laterals  
and canines



**AG1-067**  
Set of 10 Pieces  
Fig. 1  
Fig. 7  
Fig. 13  
Fig. 17  
Fig. 18  
Fig. 22  
Fig. 51A  
Fig. 67  
Fig. 74N  
Fig. 79

Fig. 7  
upper premolars



Fig. 13  
lower premolars



Fig. 17  
upper molars, right



Fig. 18  
upper molars, left



Fig. 22  
lower roots



Fig. 51A  
upper roots



Fig. 67  
upper third molars



Fig. 74N  
lower molar



Fig. 79  
lower third molars



Extracting forceps for upper roots



# EXTRACTING FORCEPS

- Щипцы экстракционные
  - Daviers
  - Zahnzangen
- Щипці екстракційні
  - Forceps de Extracción
  - استخراج الملقط

## Pediatric Tooth Extracting Forceps Set



**AG1-069**  
English Pattern Klein #51S  
Pedodontic Upper root



**AG1-068**  
English Pattern Klein #137  
Pedodontic, Upper Incisors Spring handle



**AG1-072**  
English Pattern Klein #5  
Pedodontic Lower Incisors.



**AG1-070**  
English Pattern Klein #139  
Pedodontic Upper Premolars

### Baby Tooth Extraction Forceps



**AG1-075**  
Fig. # 01 to 07  
Set of 7 Pieces



**AG1-073**  
English Pattern Klein #7  
Pedodontic Lower Roots,



**AG1-071**  
English Pattern Klein #3  
Pedodontic Upper Molars Universal

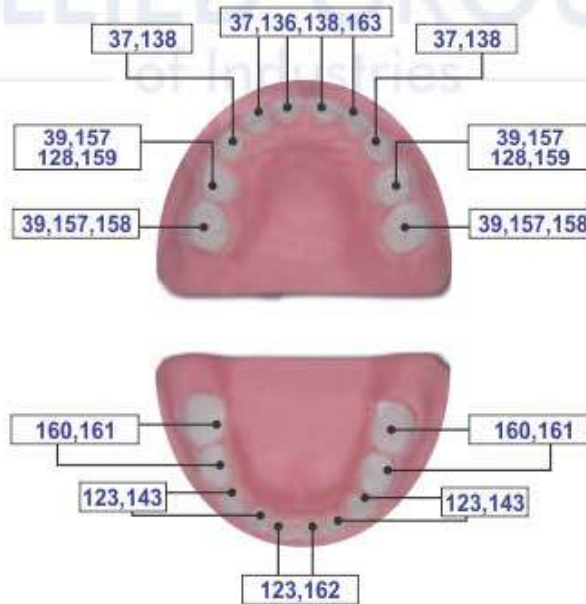

**AG1-074**  
English Pattern Klein #6  
Pedodontic Lower Molars, Spring Handle

## ROOT FRAGMENT FORCEPS



Witzel  
**AG1-076**  
170mm  
Upper roots, Universal



Witzel  
**AG1-077**  
165mm  
Lower roots, Universal



**AG1-078**  
#400(300)  
165mm  
Upper roots, Universal



**AG1-079**  
#401(301)  
160mm  
Lower roots, Universal



**AG1-080**  
Witzel Forceps With Gold  
Set of 3 Pcs



**AG1-084**  
Witzel Forceps With Hole And Screw Pattern  
Set of 3 Pcs



**AG1-088**  
Witzel Forceps With Anatomical Handle  
Set of 3 Pcs



**AG1-081**  
#401(301)  
160mm  
Lower roots, Universal



**AG1-085**  
#401(301)  
160mm  
Lower roots, Universal



**AG1-089**  
#401(301)  
160mm  
Lower roots, Universal



**AG1-082**  
#400(300)  
165mm  
Upper roots, Universal



**AG1-086**  
#400(300)  
165mm  
Upper roots, Universal



**AG1-090**  
#400(300)  
165mm  
Upper roots, Universal



Witzel  
**AG1-083**  
165mm  
Lower roots, Universal



Witzel  
**AG1-087**  
165mm  
Lower roots, Universal



Witzel  
**AG1-091**  
165mm  
Lower roots, Universal



## ROOTS SPLINTER FORCEPS

- Щипцы для удаления корневых осколков
- Pincas Fragments
- Wurzelsplitterzangen
- Щипці для видалення корневих осколків
- Pinzas Para Fragmentos
- جوار منشقة المنقط



**AG1-092**  
Splinter Forceps  
15.5cm



*Stieglitz Root Splinter Forceps*



**AG1-093**  
Splinter Forceps  
15.5cm 45°



**AG1-094**  
Stieglitz  
Root Fragments



**AG1-095**  
Stieglitz  
Root Fragments

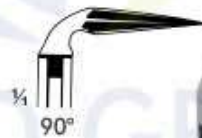

**AG1-096**  
Stieglitz Splinter Forceps  
140mm 90°



**AG1-097**  
Stieglitz Splinter Forceps  
140mm Straight

## ROOT FRAGMENT FORCEPS

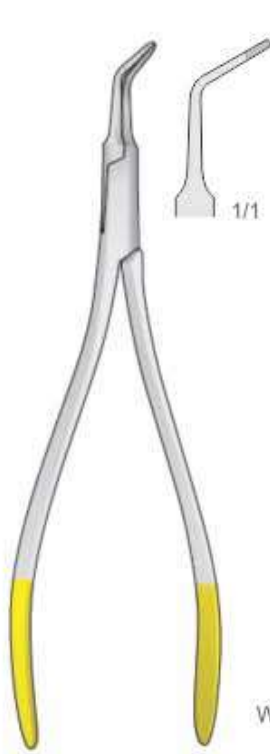

**AG1-098**  
130mm

With Diamond



**AG1-099**  
130mm

With Diamond



**AG1-100**  
125mm

With Diamond



**AG1-101**  
130mm

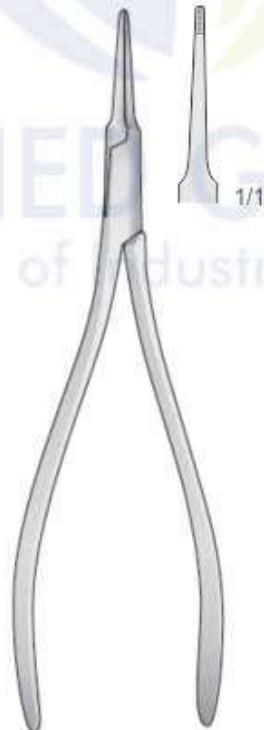

**AG1-102**  
130mm



**AG1-103**  
125mm

## EXTRACTING FORCEPS (American Pattern)

- Щипцы экстракционные (американская форма)
- Daviers - forme américaine
- Fórceps de extracción - forma americana
- Щипці екстракційні (американська форма)
- Pinzere per estrazione - forma americana
- استخراج المنطق (النمط الأمريكي)



**AG1-104**  
# 1STD  
Winter  
upper centrals and canines

**AG1-105**  
Fig. 1  
upper incisors  
and roots

**AG1-106**  
Cryer  
Fig. 150

## EXTRACTING FORCEPS (American Pattern)

- Щипцы экстракционные (американская форма)
- Щипці екстракційні (американська форма)
- Daviers - forme américaine
- Pinzere per estrazione - forma americana
- Fórceps de extracción - forma americana
- استخراج المنطق (النمط الأمريكي)



**AG1-108**  
Fig. 62  
incisors, premolars,  
deciduous teeth



**AG1-109**  
# 10S  
upper roots



**AG1-110**  
# 17  
lower molars



**AG1-111**  
Harris  
Fig. 18R



**AG1-112**  
Harris  
Fig. 18L

**AG1-107**  
Fig. 150A  
Cryer  
upper incisors, premolars, roots

## EXTRACTING FORCEPS (American Pattern)

- Щипцы экстракционные (американская форма)
- Daviers - forme américaine
- Fórceps de extracción - forma americana
- Щипці екстракційні (американська форма)
- Pinzere per estrazione - forma americana
- استخراج المثقظ (النمط الأمريكي)

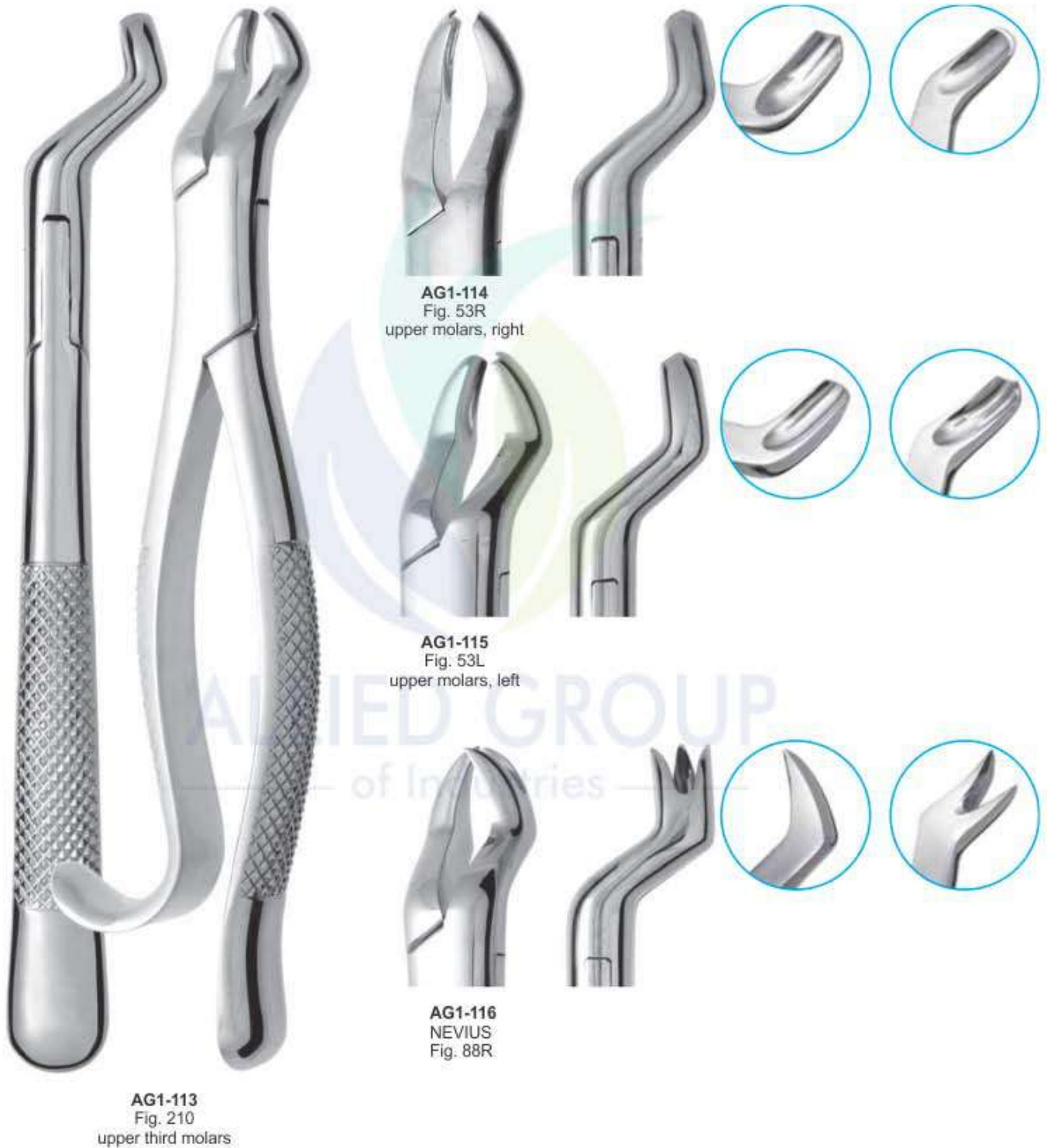

## EXTRACTING FORCEPS (American Pattern)

- Щипцы экстракционные (американская форма)
- Daviers - forme américaine
- Fórceps de extracción - forma americana
- Щипці екстракційні (американська форма)
- Pinzere per estrazione - forma americana
- استخراج المنقط (النمط الأمريكي)



**AG1-117**  
Fig. 24  
upper molars



**AG1-118**  
# 210S  
upper third molars



**AG1-119**  
# 210H  
upper third molars



**AG1-120**  
# 286  
Upper Roots,  
Premolars, Incisors



**AG1-121**  
# 99C  
Kells  
upper incisors,  
canines, premolars



**AG1-122**  
# 222  
lower third molars



**AG1-123**  
# 286  
Lower Molar

## EXTRACTING FORCEPS (American Pattern)

- Щипцы экстракционные (американская форма)
- Daviers - forme américaine
- Fórceps de extracción - forma americana
- Щипці екстракційні (американська форма)
- Pinzereper per estrazione - forma americana
- استخراج المثقظ (النمط الأمريكي)



**AG1-124**  
Nevius  
Fig. 88L  
upper molars, left

**AG1-125**  
Fig. 65  
upper incisors  
and roots

**AG1-126**  
Parmly Fig. 32A  
upper premolars  
and roots

**AG1-127**  
Parmly Fig. 32  
upper premolars  
and molars

## EXTRACTING FORCEPS (American Pattern)

- Щипцы экстракционные (американская форма)
- Щипці екстракційні (американська форма)
- Daviers - forme américaine
- Pinzere per estrazione - forma americana
- Fórceps de extracción - forma americana
- استخراج المنطق (النمط الأمريكي)

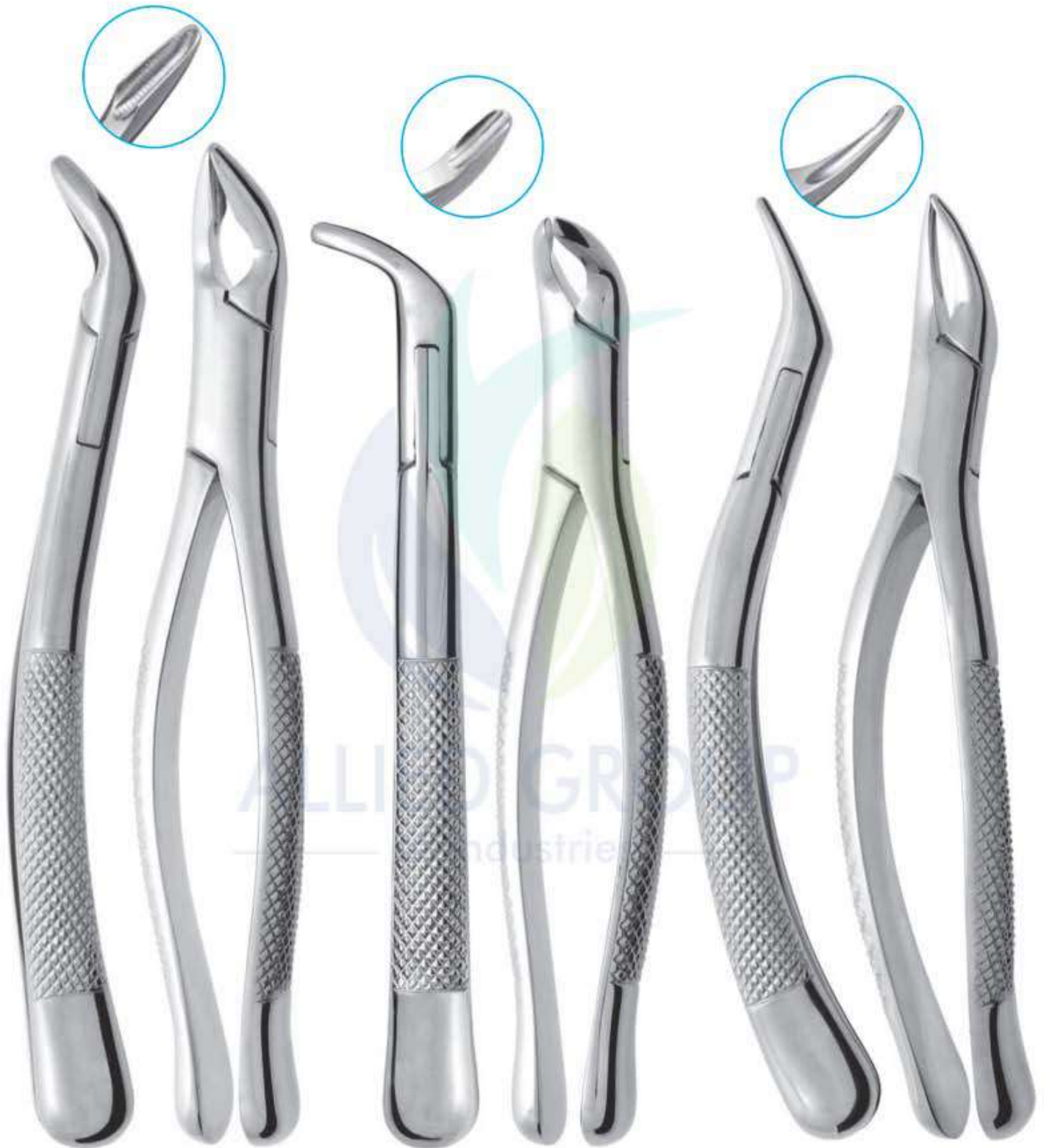

**AG1-128**  
 COHEN  
 universal

**AG1-129**  
 Fig. 203  
 lower incisors  
 and roots

**AG1-130**  
 Tomes Fig. 69  
 upper and lower  
 roots



## EXTRACTING FORCEPS (American Pattern)

- Щипцы экстракционные (американская форма)
- Щипці екстракційні (американська форма)
- Daviers - forme américaine
- Pinzere per estrazione - forma americana
- Fórceps de extracción - forma americana
- استخراج المثبط (النمط الأمريكي)



## EXTRACTING FORCEPS (American Pattern)

- Щипцы экстракционные (американская форма)
- Щипцы екстракційні (американська форма)
- Daviers - forme américaine
- Pinzere per estrazione - forma americana
- Fórceps de extracción - forma americana
- استخراج المنقط (النمط الأمريكي)



**AG1-136**  
 Hull  
 Fig. 101  
 Deciduous teeth

**AG1-137**  
 Cryer  
 Fig. 150S  
 upper teeth,  
 for children

**AG1-138**  
 Fig. 150 AS

## EXTRACTING FORCEPS (American Pattern)

- Щипцы экстракционные (американская форма)
- Daviers - forme américaine
- Fórceps de extracción - forma americana
- Щипці екстракційні (американська форма)
- Pinzere per estrazione - forma americana
- استخراج المنطق (النمط الأمريكي)



**AG1-139**  
Cryer  
Fig. 151  
lower teeth,  
for children

**AG1-140**  
Fig. 151 S  
lower incisors,  
premolars, roots

**AG1-141**  
Fig. 151 AS

## EXTRACTING FORCEPS (American Pattern)

- Щипцы экстракционные (американская форма)
- Daviers - forme américaine
- Fórceps de extracción - forma americana
- Щипці екстракційні (американська форма)
- Pinzere per estrazione - forma americana
- استخراج المنقط (النمط الأمريكي)



**AG1-142**  
**# 16S**  
lower molars for children



**AG1-143**  
**# 17S**  
lower molars



**AG1-144**  
**# 23 S**  
Lower molars



**AG1-145**  
**# 27**  
lower molars



**AG1-146**  
**# 18LS**  
upper molars left



**AG1-147**  
**# 18RS**  
upper molars right



**AG1-148**  
**# 85 Tomas**  
lower canines, premolars and molars



**AG1-149**  
**# 85A Tomas**  
lower canines, premolars and molars



**AG1-150**  
**# 69S**  
upper and lower roots



**AG1-151**  
**# 99A Kells**  
upper incisors, canines, premolars



**AG1-152**  
**# 217**  
lower molars

## EXTRACTING FORCEPS (American Pattern)

- Щипцы экстракционные (американская форма)
- Щипці екстракційні (американська форма)
- Daviers - forme américaine
- Pinzere per estrazione - forma americana
- Fórceps de extracción - forma americana
- استخراج المنطق (النمط الأمريكي)



**AG1-153**  
**#10 SK**  
Upper Molars Sup



**AG1-154**  
**#17 SK Universal**  
Lower Molars



**AG1-155**  
**#23 SK Universal**  
Upper Molars



**AG1-156**  
**#69 SK Tomas**  
upper and lower roots



**AG1-157**  
**#99 SK**  
upper incisors,  
canines, premolars



**AG1-158**  
**#150 SK**  
upper incisors,  
premolars, roots



**AG1-159**  
**#151 SK**  
lower incisors,  
premolars, roots



**AG1-160**  
**#222 SK**  
lower third molars

## EXTRACTING FORCEPS (American Pattern)

- Щипцы экстракционные (американская форма)
- Щипцы екстракційні (американська форма)
- Daviers - forme américaine
- Pinzere per estrazione - forma americana
- Fórceps de extracción - forma americana
- استخراج المنطق (النمط الأمريكي)



**AG1-161**  
Fig. 1  
Upper Anterior

**AG1-162**  
Lower Molar  
Fig. 23 Cow Horn



**AG1-163**  
Fig. 74  
Lower Anterior



**AG1-164**  
Fig. 88L  
Upper Molar Left



**AG1-165**  
Fig. 88R  
Upper Molar Right



**AG1-166**  
Fig. 74  
Lower Anterior



**AG1-167**  
Fig. 106  
Lower Incisors



**AG1-168**  
Fig. 174  
Extra Narrow  
Lower Anterior  
Apical Retention  
Forceps



**AG1-169**  
Fig. 859  
Lower Molars  
Roots



## EXTRACTING FORCEPS (American Pattern)

- Щипцы экстракционные (американская форма)
- Щипці екстракційні (американська форма)
- Daviers - forme américaine
- Pinzere per estrazione - forma americana
- Fórceps de extracción - forma americana
- استخراج الملقط (النمط الأمريكي)

### Carbide Diamond Coated Point



**AG1-170**  
150 T.C.  
Carbide Serrated Beak  
Upper Incisors, Cuspids,  
Bicuspid & Roots,  
Universal



**AG1-171**  
151 T.C.  
Carbide Serrated Beak  
Lower Incisors, Cuspids,  
Bicuspid & Roots, Universal



**AG1-172**  
15TD T.C.  
Carbide Serrated Beak  
Upper Incisors, Cuspids,



**AG1-173**  
17 T.C.  
Carbide Serrated Beak  
1st & 2nd Lower Molars,  
Universal



**AG1-174**  
53L T.C.  
Carbide Serrated Beak  
1st & 2nd Upper Molars,  
Left



**AG1-175**  
53R T.C.  
Carbide Serrated Beak  
1st & 2nd Upper Molars,  
Right



**AG1-176**  
65 T.C.  
Carbide Serrated Beak  
Upper Incisors, Roots &  
Fragments



**AG1-177**  
69 T.C.  
Carbide Serrated Beak  
Upper & Lower Fragments  
And Roots



**AG1-178**  
150S T.C. Pedro forcep  
Carbide Serrated Beak  
Pedo, Upper Primary Teeth  
and Roots, Universal



**AG1-179**  
151S T.C. Pedro forcep  
Carbide Serrated Beak  
Pedo, Lower Primary Teeth  
and Roots, Universal

## BONE ROUNGER

- Костные кусачки
- Hohlmeißelzangen
- Pincés-gouges
- Кусачки для кісток
- Pinzas-gubias
- رولنجورس العظام



**AG1-180**  
Blumenthal  
15cm



**AG1-181**  
Blumenthal  
15cm



**AG1-182**  
Blumenthal  
15cm



**AG1-183**  
Friedman  
14cm



**AG1-184**  
Friedman  
14.5cm



**AG1-185**  
Micro-Friedman  
14cm



**AG1-186**  
Micro-Friedman  
15cm



**AG1-187**  
Micro-Friedman  
16cm



**AG1-188**  
Kleinert-Kutz  
18.5cm



**AG1-189**  
Beyer  
18.5cm



**AG1-190**  
Mead 1A  
18.5cm



**AG1-191**  
Luer  
18.5cm



## EXTRACTING FORCEPS (English Pattern)

- Щипцы экстракционные (английская форма)
- Щипці екстракційні (англійська форма)
- Forceps de Extracción (Forme Inglesa)
- استخراج الملقط (نمط اللغة الإنجليزية)
- Daviers (Forme Anglaise)
- Forceps de Extracción (Forme Inglesa)
- Zahnzangen (Englische Form)

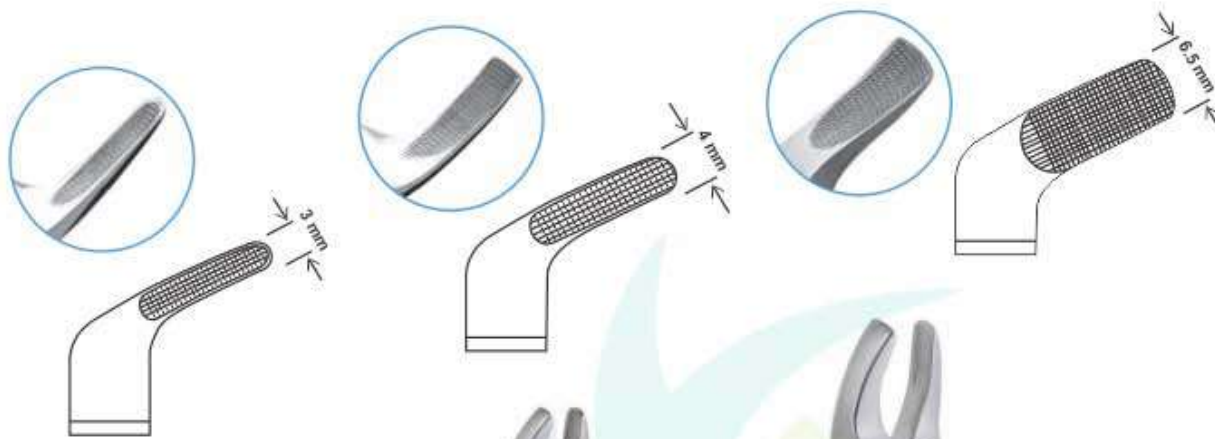

**AG1-192**  
Meissner  
Extracting Forceps



**AG1-193**  
Meissner  
Extracting Forceps



**AG1-194**  
Meissner  
Extracting Forceps



**AG1-195**  
Comellas Forceps  
Anatomical Handle

## DENTAL SYRINGES

- Шприцы стоматологические карпульные
  - Seringues à usage dentaire
  - Dentspritzen
- Шприці стоматологічні карпульні
  - Jeringas dentales
  - المحاقن الأسنان



**AG1-196** 1.8ml  
**AG1-197** 2.2ml



**AG1-198** 1.8ml  
**AG1-199** 2.2ml



**AG1-200** 1.8ml  
**AG1-201** 2.2ml



**AG1-202** 1.8ml  
**AG1-203** 2.2ml



**AG1-204** 1.8ml  
**AG1-205** 2.2ml



**AG1-206** 1.8ml  
**AG1-207** 2.2ml



**AG1-208**  
# 1001  
Intraligamental  
Anesthesia  
Syringe in  
Black Colour



**AG1-209** 1.8ml  
**AG1-210** 2.2ml  
Angled



**AG1-211**  
Aluminium - Dark 1.8 ml

- |   |   |   |   |
|---|---|---|---|
|  |  |  |  |
| <b>AG1-212</b><br>Aluminium -<br>Silver 1.8 ml                                      | <b>AG1-213</b><br>Aluminium -<br>Orange 1.8 ml                                      | <b>AG1-214</b><br>Aluminium -<br>Green 1.8 ml                                       | <b>AG1-215</b><br>Aluminium -<br>Blue 1.8 ml  |



Type C  
**AG1-216** 1,8ml  
**AG1-217** 2,2ml



Type C  
**AG1-218** 1,8ml  
**AG1-219** 2,2ml



2-Ring  
**AG1-220** 1,8ml  
**AG1-221** 2,2ml



Aspirating Syringe  
**AG1-222** 1.8mm  
**AG1-223** 2.2mm



Cartridge Syringe  
**AG1-224** 1.8mm  
**AG1-225** 2.2mm



Cartridge Syringe  
**AG1-226** 1.8mm  
**AG1-227** 2.2mm



Cartridge Syringe  
**AG1-228** 1.8mm  
**AG1-229** 2.2mm

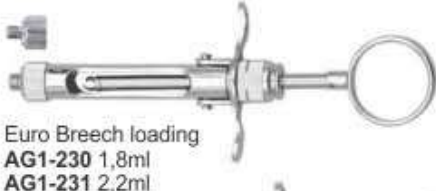

Euro Breech loading  
**AG1-230** 1,8ml  
**AG1-231** 2,2ml

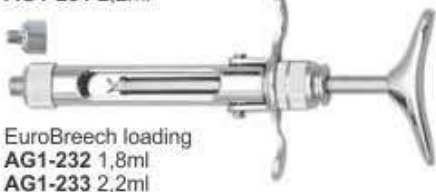

EuroBreech loading  
**AG1-232** 1,8ml  
**AG1-233** 2,2ml



Manual Aspirating Syringe  
**AG1-234** 1,8ml  
**AG1-235** 2,2ml



Quatro  
**AG1-236** 1,8ml  
**AG1-237** 2,2ml



Trio  
**AG1-238** 1,8ml  
**AG1-239** 2,2ml



Swedish Type  
**AG1-240** 1,8ml  
**AG1-241** 2,2ml



Ject Ultima  
**AG1-242** 1,8ml  
**AG1-243** 2,2ml  
Injects 0,05 ml with every click Supplied with  
angled and straight tubes



Ject angled  
**AG1-244** 1,8ml  
**AG1-245** 2,2ml

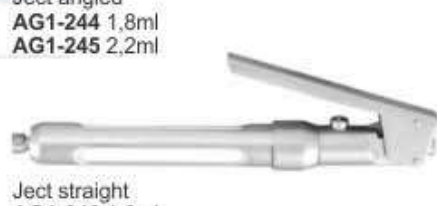

Ject straight  
**AG1-246** 1,8ml  
**AG1-247** 2,2ml



Disc System  
**AG1-248** 1,8ml  
**AG1-249** 2,2ml



Disc System  
**AG1-250** 1,8ml

## EXTRACTING FORCEPS SET

Извлечение щипцов  
Ensemble de pinces d'extraction  
• Zange sammeln

• Витягуючий комплект щипців  
• Extracción del conjunto de fórceps  
• استخراج ملقط مجموعة



**AG1-251**  
Extracting Forceps  
Set of 10 Pieces  
Extracting Forceps Fig. 2  
Extracting Forceps Fig. 7  
Extracting Forceps Fig. 13  
Extracting Forceps Fig. 17  
Extracting Forceps Fig. 18  
Extracting Forceps Fig. 22  
Extracting Forceps Fig. 33  
Extracting Forceps Fig. 51A  
Extracting Forceps Fig. 67A  
Extracting Forceps Fig. 79



**AG1-252**  
Extracting Forceps  
Set of 10 Pieces  
Extracting Forceps Fig. 2  
Extracting Forceps Fig. 7  
Extracting Forceps Fig. 13  
Extracting Forceps Fig. 17  
Extracting Forceps Fig. 18  
Extracting Forceps Fig. 22  
Extracting Forceps Fig. 33  
Extracting Forceps Fig. 51A  
Extracting Forceps Fig. 67A  
Extracting Forceps Fig. 79



**AG1-253**  
Extracting Forceps  
Set of 13 Pieces  
Extracting Forceps Fig. 2  
Extracting Forceps Fig. 7  
Extracting Forceps Fig. 13  
Extracting Forceps Fig. 17  
Extracting Forceps Fig. 18  
Extracting Forceps Fig. 22  
Extracting Forceps Fig. 33  
Extracting Forceps Fig. 51A  
Extracting Forceps Fig. 67A  
Extracting Forceps Fig. 79  
Extracting Forceps Fig. 86C  
Extracting Forceps Fig. 89  
Extracting Forceps Fig. 90



**AG1-254**  
Extracting Forceps Children Pattern  
Set of 10 Pieces  
Extracting Forceps Fig. 13S  
Extracting Forceps Fig. 22S  
Extracting Forceps Fig. 30S  
Extracting Forceps Fig. 33S  
Extracting Forceps Fig. 37  
Extracting Forceps Fig. 38  
Extracting Forceps Fig. 39  
Extracting Forceps Fig. 39L  
Extracting Forceps Fig. 39R  
Extracting Forceps Fig. 51S



**AG1-255**  
Extracting Forceps English adult Adult  
Set of 10 Pcs



**AG1-256**  
Extracting Forceps American Adult  
Set of 10 Pcs



**AG1-257**  
Extracting Forceps American Adult  
Set of 8 Pcs



**AG1-258**  
Extracting Forceps Pedro  
Set of 7 Pcs

## ROOT ELEVATOR

### FUNCTION OF ROOT ELEVATORS IN SURGERY

To Loosen Tooth or Root From Bony Socket Prior to Placement of The Extraction Forceps.

## HANDLES FOR ROOT ELEVATORS POINTS A, B, C, D, E, F, G, H



# ROOT ELEVATOR

- Элеватор корневой экстракционный
- Elévateurs à racines
- Wurzelheber
- Elevator corneviu extracționii
- Elevadores para raíces
- المصاعد الجذر

## Function of Root Elevators:

To loosen tooth or root from bony socket prior to placement of the extraction forceps.

### Apexo Root Elevators



### Luxator Root Elevators



### Bein Root Elevators

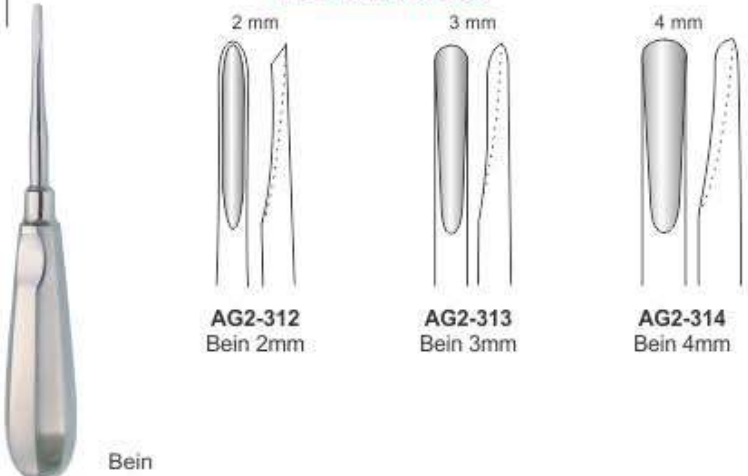

### Seldin Root Elevators

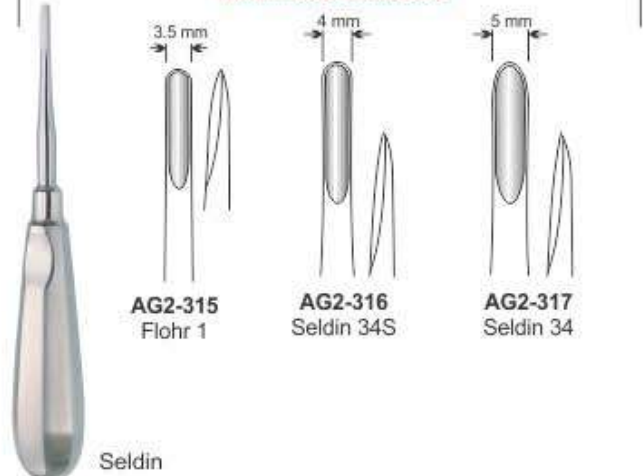

# ROOT ELEVATOR

- Элеватор корневой экстракционный
- Elévateurs à racines
- Wurzelheber
- Слеватор корневий экстракційний
- Elevadores para raices
- المصاعد الجذر

**FUNCTION:** To loosen tooth or root from bony socket prior to placement of the extraction forceps.

## Laxutor Root Elevators

Long Type



Laxutor  
Root Elevator



**AG2-318**  
Laxutor  
1.5mm  
Str.



**AG2-319**  
Laxutor  
2mm  
Str.



**AG2-320**  
Laxutor  
3mm  
Str.



**AG2-321**  
Laxutor  
5mm  
Str.



**AG2-322**  
Laxutor  
3mm  
Cvd.



**AG2-323**  
Laxutor  
5mm  
Cvd.



**AG2-324**  
Laxutor  
3mm  
Upper Angle



**AG2-325**  
Laxutor  
3mm  
Double Angle



**AG2-326**  
Laxutor  
3mm  
Str.



**AG2-327**  
Laxutor  
5mm  
Str.



# ROOT ELEVATOR

- Элеватор корневой экстракционный
  - Elévateurs à racines
  - Wurzelheber
- Єлеватор корневий екстракційний
  - Elevadores para raices
  - المصاعد الجذر

## Laxutor Root Elevators



lower roots elevator



Upper root elevator with helicoidal tip

## Luxator Roots Elevator



AG2-337  
Luxator  
Straight

AG2-338  
Luxator  
Curved

### Function of Root Elevators:

To loosen tooth or root from bony socket prior to placement of the extraction forceps.

## Apical Root Elevators

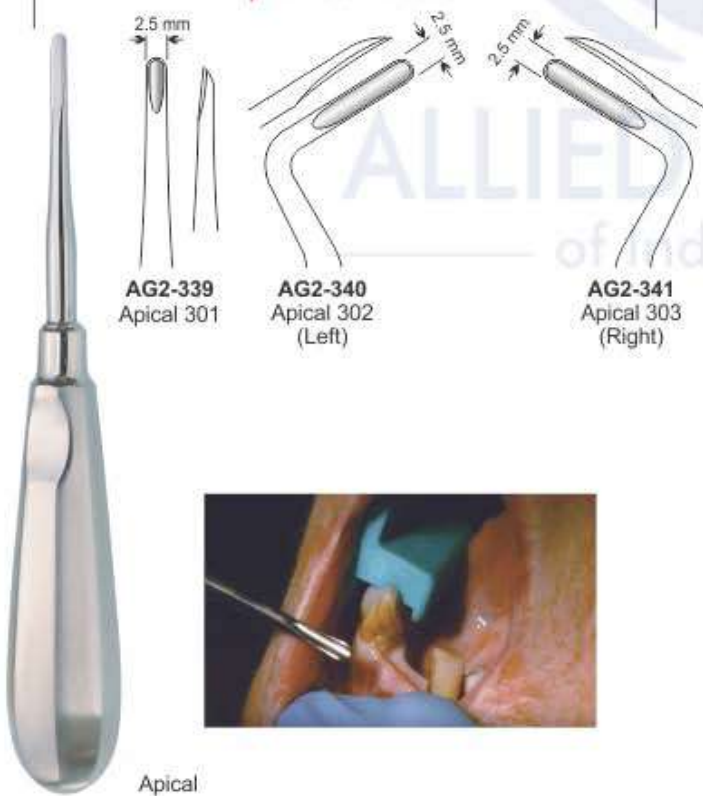

AG2-339  
Apical 301

AG2-340  
Apical 302  
(Left)

AG2-341  
Apical 303  
(Right)

Apical

## Apical Root Elevators

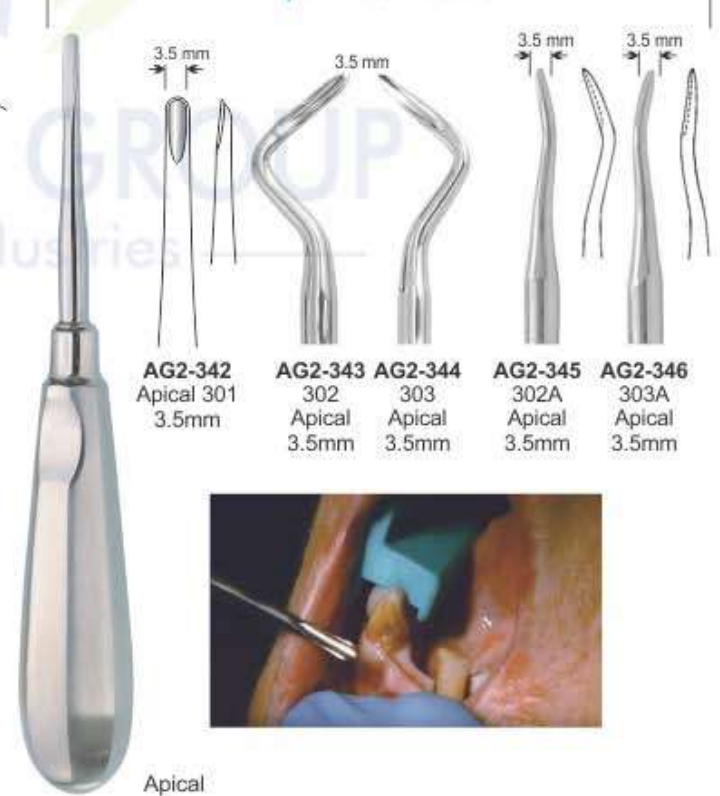

AG2-342  
Apical 301  
3.5mm

AG2-343  
302  
Apical  
3.5mm

AG2-344  
303  
Apical  
3.5mm

AG2-345  
302A  
Apical  
3.5mm

AG2-346  
303A  
Apical  
3.5mm

Apical

# ROOT ELEVATOR

- Элеватор корневой экстракционный
- Elévateurs à racines
- Wurzelheber
- Слеватор корневий екстракційний
- Elevadores para raices
- المصاعد الجذر

**FUNCTION:** To Loosen Tooth or Root From Bony Socket Prior to Placement of The Extraction Forceps.

## Cryer Root Elevators



Cryer  
Root Elevator



Cryer root or fragment elevator.



Seldin root or fragment elevator

## Seldin Root Elevators



Seldin



Cryer root or fragment elevator



Seldin root or fragment elevator



# ROOT ELEVATOR

- Элеватор корневой экстракционный
  - Elévateurs à racines
  - Wurzelheber
- Слеватор корневий экстракційний
  - Elevadores para raices
  - المصاعد الجذر

**FUNCTION:** To Loosen Tooth or Root From Bony Socket Prior to Placement of The Extraction Forceps.

## Apical Root Elevators

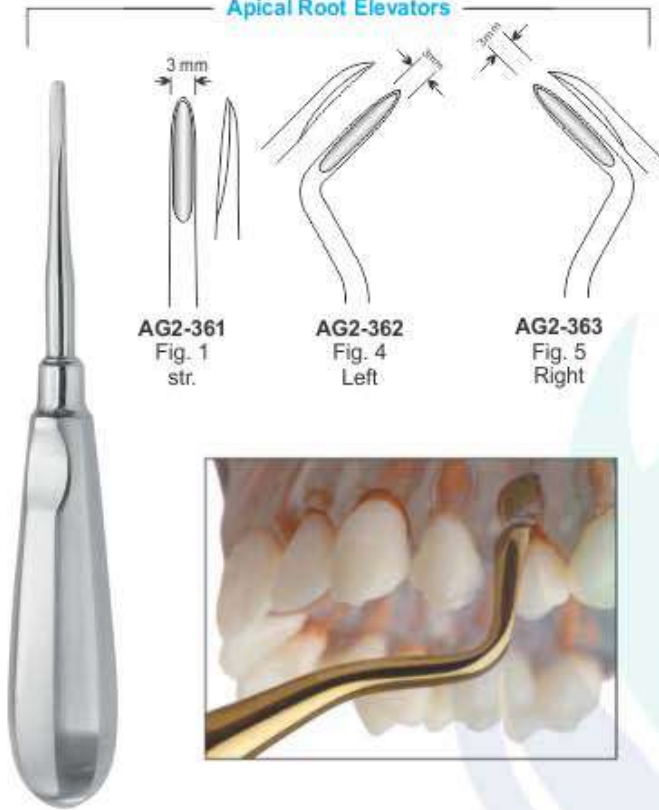

## Apical Root Elevators

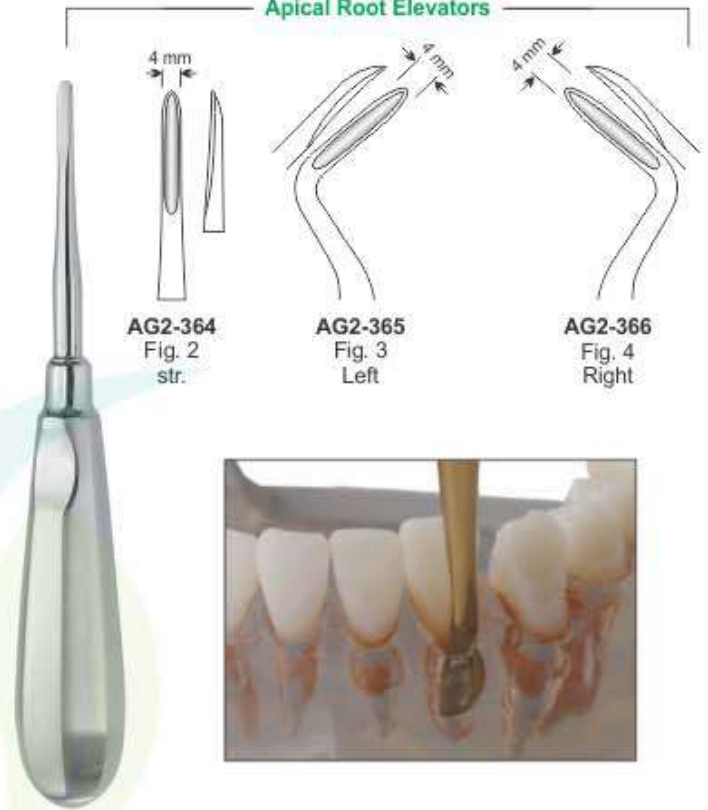

## Flohr Root Elevators



## Heidbrink Root Elevators

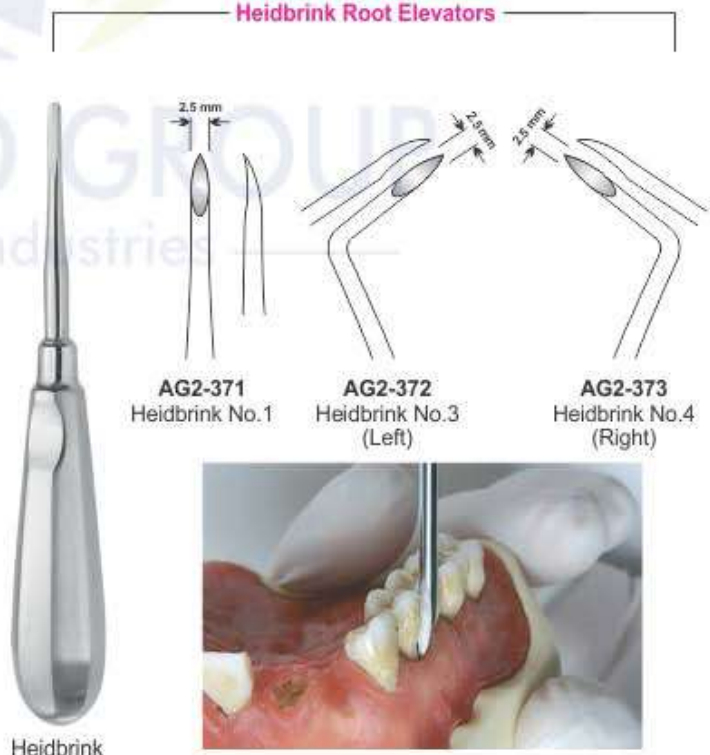

# ROOT ELEVATOR

- Элеватор корневой экстракционный
- Elévateurs à racines
- Wurzelheber
- Слеватор корневий экстракційний
- Elevadores para raices
- المصاعد الجذر

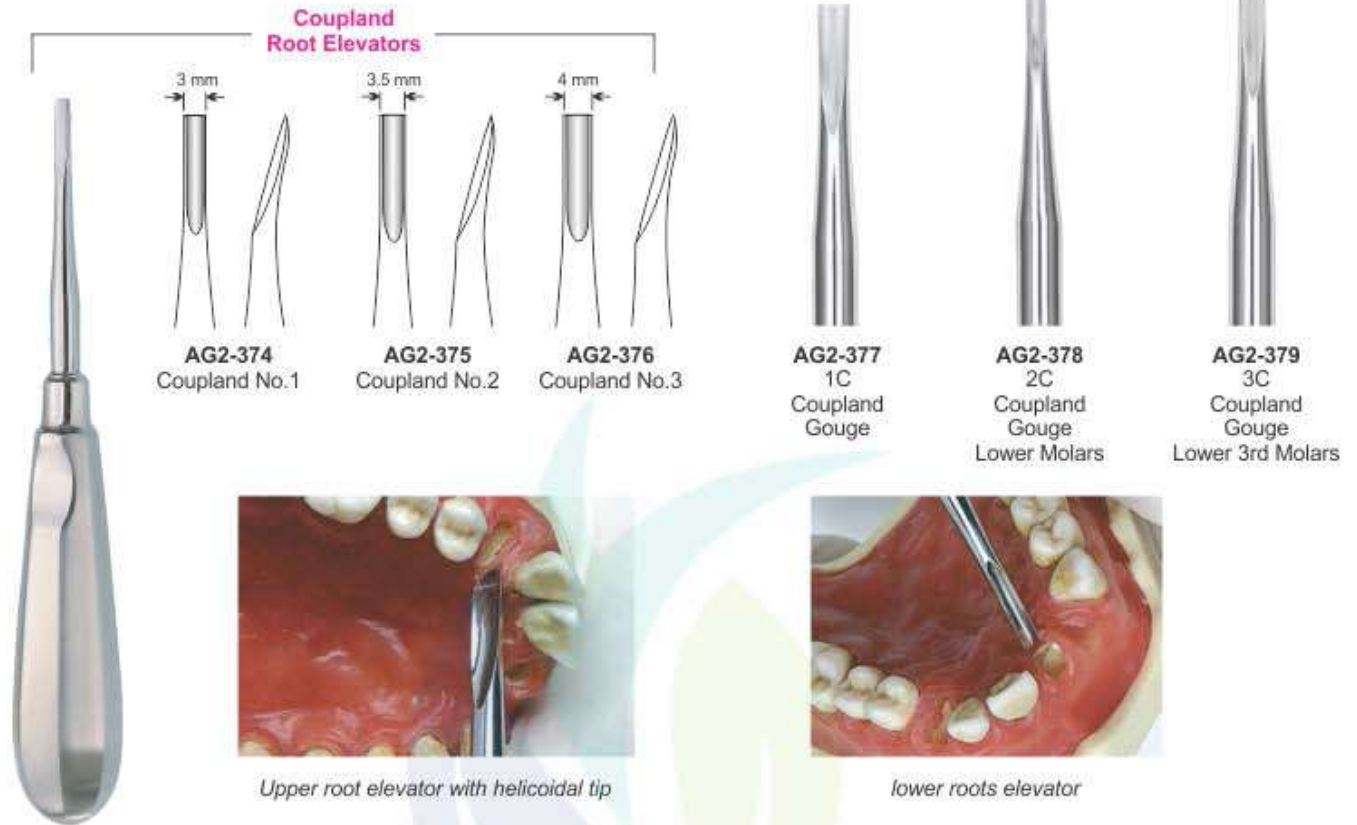

**FUNCTION:** To Loosen Tooth or Root From Bony Socket Prior to Placement of The Extraction Forceps.

## ENGLISH PATTERNS



# ROOT ELEVATOR

- Элеватор корневой экстракционный
- Elévateurs à racines
- Wurzelheber
- Слеватор корневий экстракційний
- Elevadores para raices
- المصاعد الجذر

## Lindo Levian Root Elevators



### Function of Root Elevators:

To loosen tooth or root from bony socket prior to placement of the extraction forceps.



**AG2-393**  
Lindo-Levian  
Serrated Curved

**AG2-394**  
Lindo-Levian  
Serrated Right



Bein  
AG2-395



Bein  
AG2-396



Bein  
AG2-397



Bein  
AG2-398



Gartner  
AG2-399



Gartner  
AG2-400



Gartner  
AG2-401

## ROOT ELEVATOR

- Элеватор корневой экстракционный
- Elévateurs à racines
- Wurzelheber
- Слеватор корневий екстракційний
- Elevadores para raices
- المصاعد الجذر

### Friedmann Roots Elevator



**AG2-402**  
Friedmann 4F  
Str.

**AG2-403**  
Friedmann 5F  
Left

**AG2-404**  
Friedmann 6F  
Right

### Luxating Elevator With Periotome Tip



**AG2-405**  
3mm Luxating  
Elevator / Periotome

**AG2-406**  
4mm Luxating  
Elevator / Periotome

**AG2-407**  
5mm Luxating  
Elevator / Periotome

### Wisdom Roots Elevator



**AG2-408**  
Wisdom  
for 18 and 38

**AG2-409**  
Wisdom  
for 28 and 48

**Function of Root Elevators:** To loosen tooth or root from bony socket prior to placement of the extraction forceps.

### Bayonet Roots Elevator Set



**AG2-410**  
Left

**AG2-411**  
Right

**AG2-412**  
bayonet

**AG2-413**  
Curved

**AG2-414**  
Straight

# ROOT ELEVATOR

- Элеватор корневой экстракционный
- Elévateurs à racines
- Wurzelheber
- Слеватор корневий екстракційний
- Elevadores para raices
- المصاعد الجذر

## Miller Root Elevators



**Function of Root Elevators:** To loosen tooth or root from bony socket prior to placement of the extraction forceps.

## Claw-Lift Roots Elevator

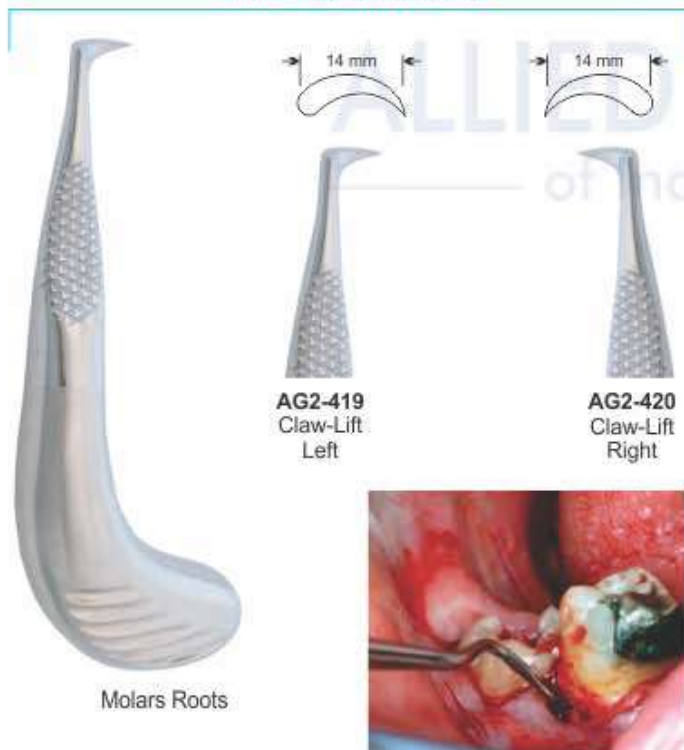

## Schlemmer Roots Elevator



## ROOT ELEVATOR

- Элеватор корневой экстракционный
- Elévateurs à racines
- Wurzelheber
- Слеватор корневий екстракційний
- Elevadores para raices
- المصاعد الجذر

**FUNCTION:** To Loosen Tooth or Root From Bony Socket Prior to Placement of The Extraction Forceps.

**Laxutor Root Elevators Set of 9 Pcs**



AG2-424  
2mm Str.



AG2-425  
3mm Str.



AG2-426  
5mm Str.



AG2-427  
3mm Cvd.



AG2-428  
5mm Cvd.



AG2-429  
3mm Angle



AG2-430  
3mm Angle



AG2-431  
3mm Str.



AG2-432  
5mm Str.



# ROOT ELEVATOR

- Элеватор корневой экстракционный
- Elévateurs à racines
- Wurzelheber
- Слеватор корневий экстракційний
- Elevadores para raices
- المصاعد الجذر

## Hylin Roots Elevator



**Function of Root Elevators:** To loosen tooth or root from bony socket prior to placement of the extraction forceps.

## Kopp Roots Elevator

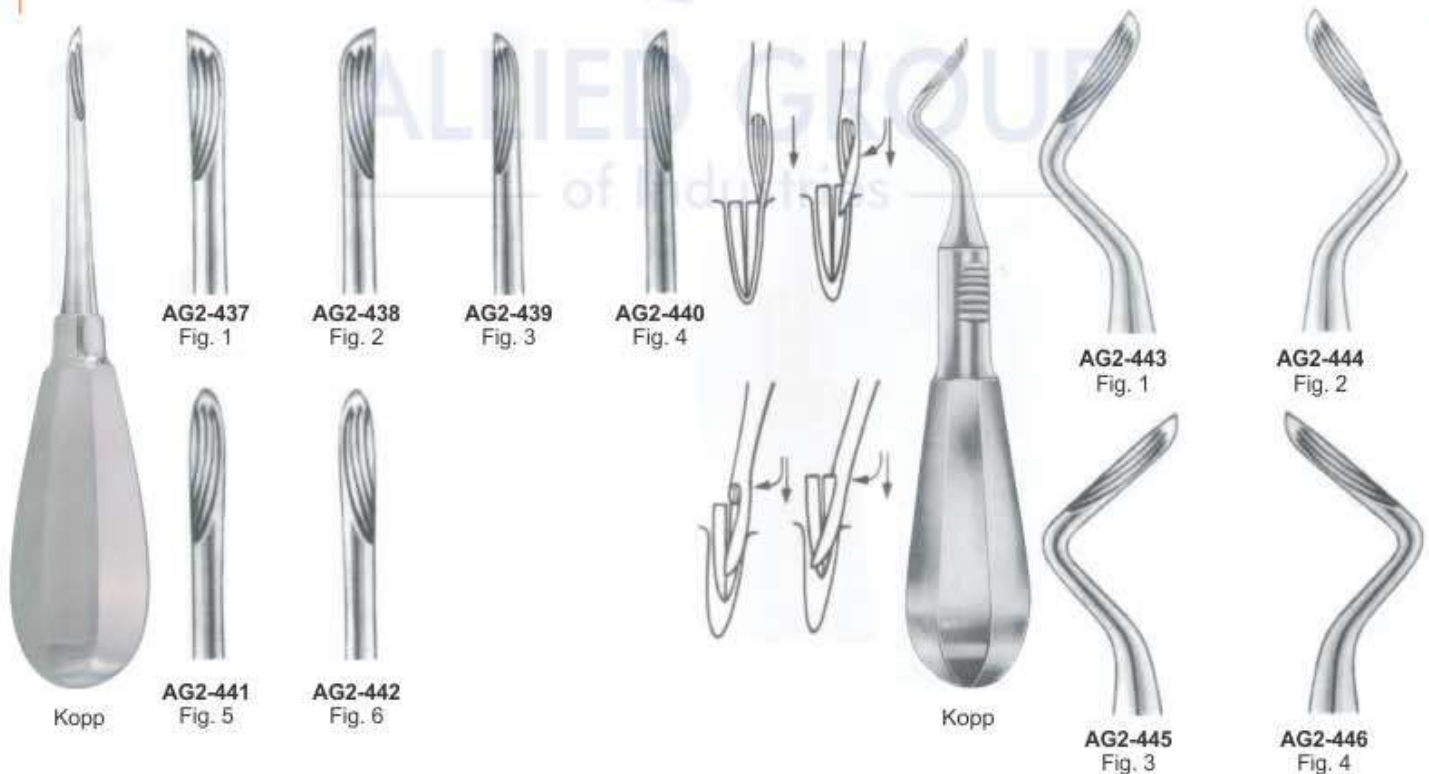

## ROOT ELEVATOR

- Элеватор корневой экстракционный
- Elévateurs à racines
- Wurzelheber
- Слеватор корневий екстракційний
- Elevadores para raíces
- المصاعد الجذر

### Luxier Roots Elevator



AG2-447  
Luxier  
Cvd.

AG2-448  
Luxier  
Str.



### Heber Roots Elevator



AG2-449  
Heber  
Bayonet

AG2-450  
Heber  
Bayonet



### Bein Roots Elevator



AG2-451  
Bein,  
3mm

AG2-452  
Bein,  
4mm

**Function of Root Elevators:** To loosen tooth or root from bony socket prior to placement of the extraction forceps.

### Bein Roots Elevator





# ROOT ELEVATOR

- Элеватор корневой экстракционный
- Elévateurs à racines
- Wurzelheber
- Слеватор корневий экстракційний
- Elevadores para raices
- المصاعد الجذر

## W. Barry Roots Elevator



AG2-465  
W. Barry  
Fig. 1



AG2-466  
W. Barry  
Fig. 2



AG2-467  
W. Barry  
Fig. 3



AG2-468  
W. Barry  
Fig. 4



**Function of Root Elevators:** To loosen tooth or root from bony socket prior to placement of the extraction forceps.



Winter  
Fig. 1L  
125mm



AG2-469  
Winter  
Fig. 1L



AG2-470  
Winter  
Fig. 1R



AG2-471  
775/3  
Winter  
11 L



AG2-472  
775/4  
Winter  
11 R



AG2-473  
775/5  
Winter  
12 L



AG2-474  
775/6  
Winter  
12 R



AG2-475  
775/7  
Winter  
13 L



AG2-476  
775/8  
Winter  
13 R



AG2-477  
Winter  
Fig. 1L



AG2-478  
Winter  
Fig. 1R



AG2-479  
Lecluse  
bayonet



AG2-480  
Potts "T-Handle"  
Elevator-Left



AG2-481  
Potts "T-Handle"  
Elevator-Right

## ROOT ELEVATOR

- Элеватор корневой экстракционный
- Elévateurs à racines
- Wurzelheber
- Слеватор корневий екстракційний
- Elevadores para raíces
- المصاعد الجذر



AG2-482  
Fig. 1  
Chompret



AG2-483  
Fig. 2  
Chompret



AG2-484  
Fig. 3  
Chompret



AG2-485  
Fig. 4  
Chompret



*Lecluse elevator for lower third molar dislocation*



*Chompret syndesmotome, sickle pattern*



AG2-486



AG2-487



AG2-488



AG2-489



AG2-490



AG2-491



AG2-492

### Root Pick Elevator With Gold Flexible Points

# ROOT ELEVATOR

- Элеватор корневой экстракционный
- Elévateurs à racines
- Wurzelheber
- Слеватор корневий экстракційний
- Elevadores para raices
- المصاعد الجذر

## Heidbrink Roots Elevator



**AG2-493**  
Heidbrink  
Straight

**AG2-494**  
Heidbrink  
Left

**AG2-495**  
Heidbrink  
Right

**AG2-496**  
Heidbrink  
Straight

**AG2-497**  
Heidbrink  
Left

**AG2-498**  
Heidbrink  
Right

## Syndesmotomes Roots Elevator



**AG2-499**  
Straight

**AG2-500**  
Left

**AG2-501**  
Right

## Periotome Roots Elevator



**AG2-502**  
Periotome  
2.1mm  
Straight

**AG2-503**  
Periotome  
2.6mm  
Straight

**AG2-504**  
Periotome  
2.1mm  
Angular

**AG2-505**  
Periotome  
2mm  
Curved

**AG2-506**  
Periotome  
2.0mm

**AG2-507**  
Periotome  
2.5mm

**AG2-508**  
Periotome  
3.0mm

**AG2-509**  
Periotome  
4.0mm

Syndesmotomes

## ROOT ELEVATOR

- Элеватор корневой экстракционный
- Elévateurs à racines
- Wurzelheber
- Слеватор корневий екстракційний
- Elevadores para raices
- المصاعد الجذر

**FUNCTION:** To loosen small root fragments from bony socket

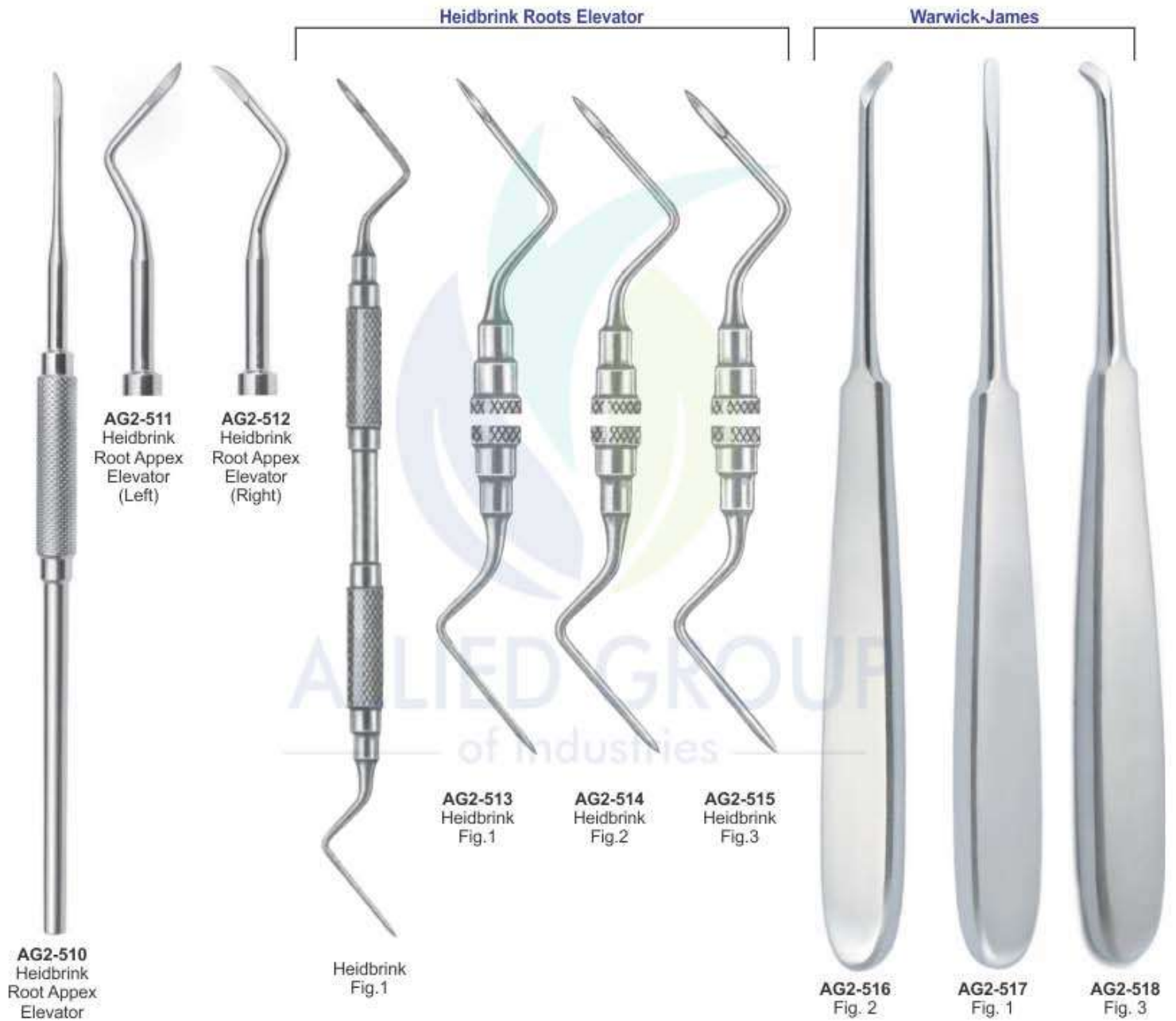

## ROOT ELEVATOR

- Элеватор корневой экстракционный
- Elévateurs à racines
- Wurzelheber
- Єлеватор корневий екстракційний
- Elevadores para raices
- المصاعد الجذر



**AG2-519**  
1S  
(Straight 1mm)



**AG2-520**  
2S  
(Straight 2mm)



**AG2-521**  
3S  
(Straight 3mm)



**AG2-522**  
5S  
(Straight 5mm)



**AG2-523**  
3C  
(Curved 3mm)



**AG2-524**  
5C  
(Curved 5mm)



**AG2-525**  
3CA  
(Curved Angle 3mm)



**AG2-526**  
3IC  
(Inverted Curved 3mm)



**AG2-527**  
DE 3  
(Dual Edge 3mm / 1.5mm)



**AG2-528**  
DE 5  
(Dual Edge 5mm / 3mm)

## ROOT ELEVATOR

- Элеватор корневой экстракционный
- Elévateurs à racines
- Wurzelheber
- Слеватор корневий екстракційний
- Elevadores para raíces
- المصاعد الجذر



**AG2-529**  
Luxators Set of 7 Pcs

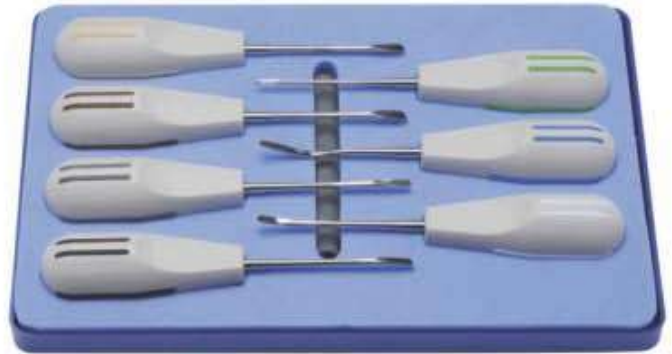

**AG2-530**  
Luxators Set of 7 Pcs



**AG2-531**  
Luxators Set of 8 Pcs



**AG2-532**  
Root Elevators Set of 10 Pcs



**AG2-533**  
Elevators Set of 8 Pcs



**AG2-534**  
Elevators Set of 8 Pcs

# ROOT ELEVATOR

- Элеватор корневой экстракционный
  - Élévateurs à racines
  - Wurzelheber
- Слеватор корневий экстракційний
  - Elevadores para raíces
  - المصاعد الجذر

## PDL ELEVATORS

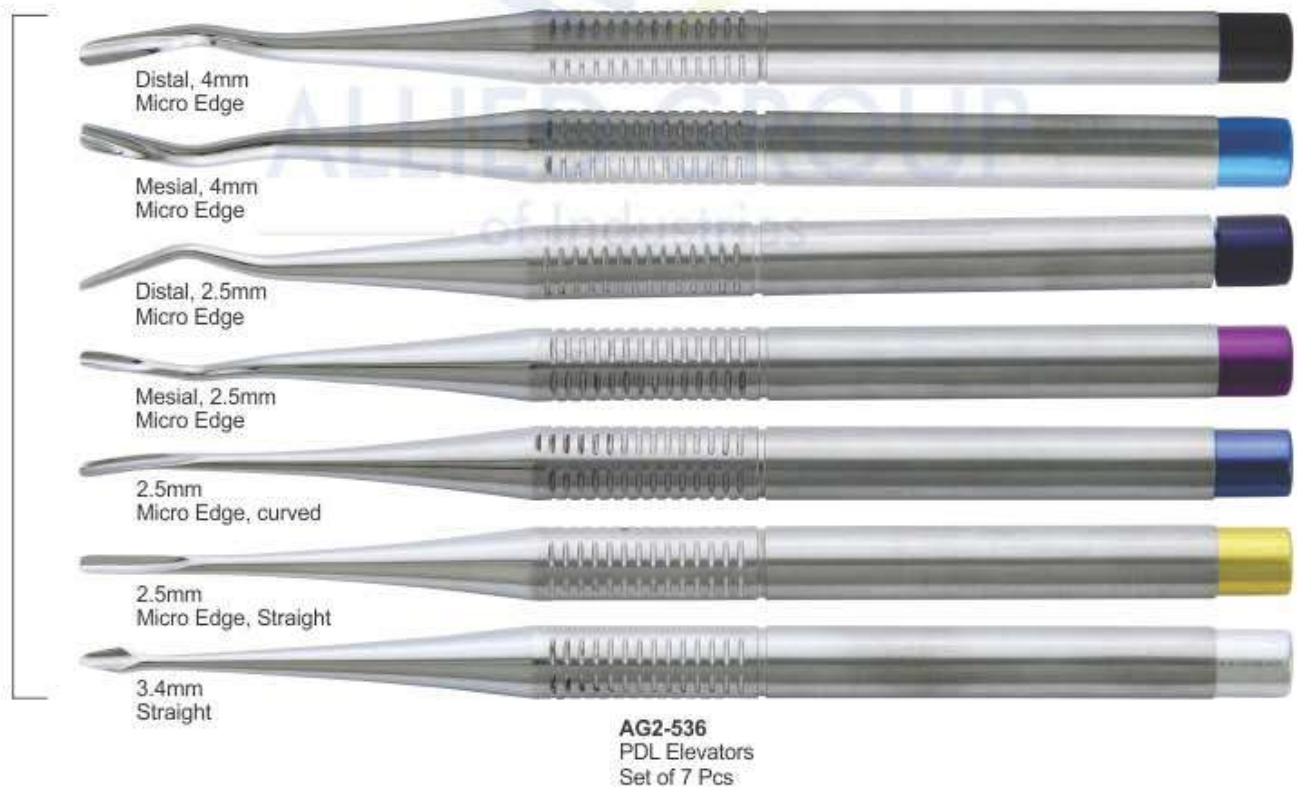
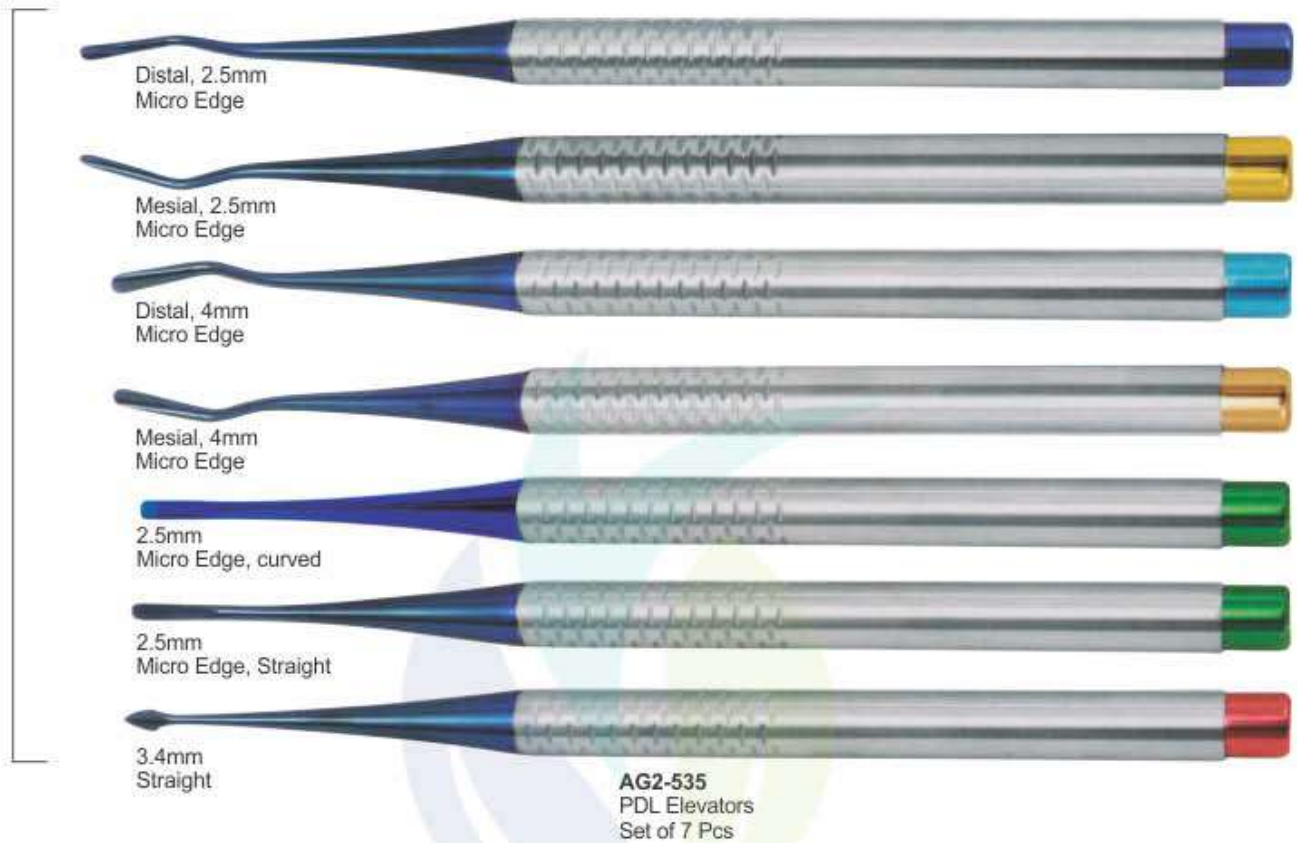

## ROOT ELEVATOR

- Элеватор корневой экстракционный
- Elévateurs à racines
- Wurzelheber
- Слеватор корневий екстракційний
- Elevadores para raíces
- المصاعد الجذر

### PDL ELEVATORS

Delicate Arrow tip



4,0mm straight  
4,0mm curved

Luxivators straight  
atraumatic luxation of the tooth



2,5mm straight  
3,5mm straight  
4,5mm straight

Luxivators curved  
atraumatic luxation of the tooth



2,5mm curved  
3,5mm curved  
4,5mm curved



AG2-537  
PDL Elevators  
Set of 8 Pcs



## Our Scalers

Compare our scalers and curettes with the best in the industry and you will immediately recognize we are equal in every way but one... price. Note the deep precision knurling for better tactile feel. The same high-grade stainless steel tips, the same light weight (under 18 grams) for less hand fatigue, the same professional craftsmanship, and surpassing the highest industry standards. of course, any manufacturer can make these claims, but we guarantee and certify ours.

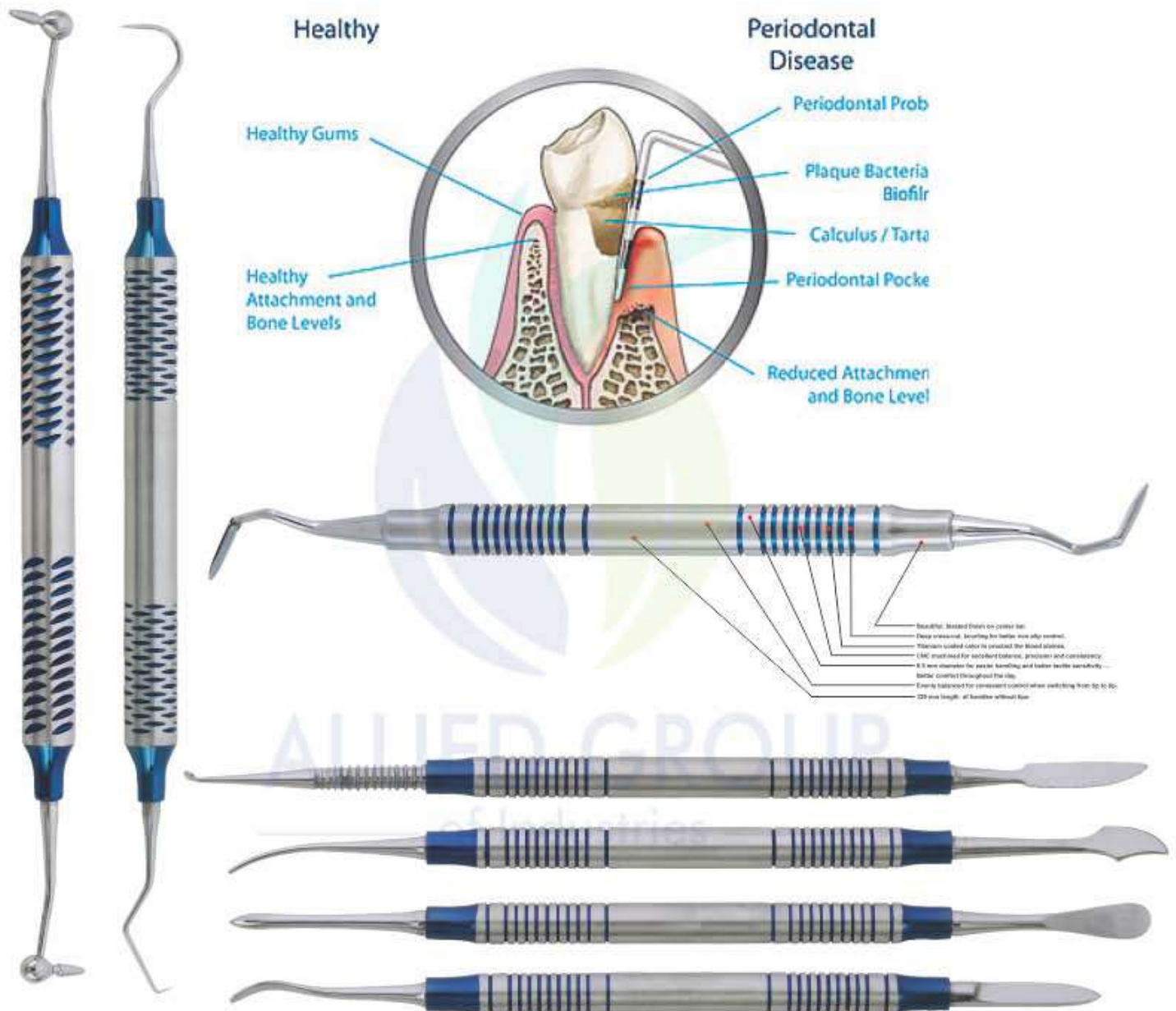

- High-polish mirror finish tips.
- Manufactured within the guidelines of the FDA quality assurance system for good manufacturing practices.
- Highest grade German stainless steel, razor sharp, durable tips. Rockwell hardened to 60 RHc.
- 27 of the most popular designs from gracesys to McCalls to columbias, and many european patterns.
- All instruments are guaranteed against defects in material and workmanship.

- All instruments bear the ce mark, emblematic of the european community's highest standards.
- Customer satisfaction guarantee, too!
- Less than 20 grams ... Lightweight for less hand fatigue.
- Manufactured to the most exacting standards so the 50th instrument you buy is exactly like your first.
- You decide ... Why pay more for the same high-quality instruments?

## DIAGNOSTIC, PERIODONTAL & RESTORATIVE INSTRUMENTS

### VALUED BUYERS

Compare our scalers and curettes with the best in the industry and you will immediately recognize we are equal in every way but one... price. Note the deep precision knurling for better tactile feel. The same high-grade stainless steel tips, the same light weight (under 20 grams) for less hand fatigue, the same professional craftsmanship, and surpassing the highest industry standards. Of course, any manufacturer can make these claims, but we guarantee and certify ours. We regularly manufacturing below articles in showing handles & pattern A to L for better grip & perfection. We are also fully equipped & capable to develop these instruments as per your own specific requirements & demands in materials, sizes, shapes and patterns.



A-Hollow Handle Ø 10 mm



B-Hollow Handle Ø 10 mm



C-Hollow Handle Ø 10 mm



D-Hollow Handle Ø 10 mm



E-Hollow Handle Ø 10 mm



F-Hollow Handle Ø 10 mm



G-Hollow Handle Ø 10 mm



H-Hollow Handle Ø 6.4 mm



I-Hollow Handle Ø 8 mm



J-Hollow Handle Ø 10 mm



K-Soild Handle Ø 6 mm



L-Soild Handle Ø 6 mm

# MOUTH MIRRORS

- зеркал
- Espejos de la boca
- Mundspiegel
- дзеркал
- Miroirs à la bouche
- مرايا الفم

## Plain



**AG3-600** Fig. 3 Ø20mm  
**AG3-601** Fig. 4 Ø22mm  
**AG3-602** Fig. 5 Ø24mm  
**AG3-603** Fig. 6 Ø26mm

## Cone-Socket Plain



**AG3-604** Fig. 3 Ø20mm  
**AG3-605** Fig. 4 Ø22mm  
**AG3-606** Fig. 5 Ø24mm

## Magnifying



**AG3-607** Fig. 3 Ø20 mm  
**AG3-608** Fig. 4 Ø22 mm  
**AG3-609** Fig. 5 Ø24 mm

## Cone-Socket Magnifying



**AG3-610** Fig. 3 Ø20mm  
**AG3-611** Fig. 4 Ø22mm  
**AG3-612** Fig. 5 Ø24mm

## Rhodium



**AG3-613** Fig. 3 Ø20mm  
**AG3-614** Fig. 4 Ø22mm  
**AG3-615** Fig. 5 Ø24 mm

## Cone-Socket Rhodium



**AG3-616** Fig. 3 Ø20mm  
**AG3-617** Fig. 4 Ø22mm  
**AG3-618** Fig. 5 Ø24mm

## Front Surface



**AG3-619** Fig. 3 Ø20mm  
**AG3-620** Fig. 4 Ø22mm  
**AG3-621** Fig. 5 Ø24mm  
**AG3-622** Fig. 6 Ø26mm

## Cone-Socket Front Surface



**AG3-623** Fig. 3 Ø20mm  
**AG3-624** Fig. 4 Ø22mm  
**AG3-625** Fig. 5 Ø24mm

## HANDLES FOR MOUTH MIRRORS

- Ручки для зеркал
- Manches pour miroirs à bouche
- Mundspiegelgriffe
- Ручки для дзеркал
- Mangos para espejos de boca
- مقابض لمرآة الفم



**AG3-626**  
Hollow Mirror  
Handle Round  
Ø 10 mm



**AG3-627**  
Hollow Mirror  
Hexagonal  
Handle  
Ø 8 mm



**AG3-628**  
Hollow  
Ø 8 mm



**AG3-629**  
Hollow Mirror  
Hexagonal  
Handle  
Ø 10 mm



**AG3-630**  
Hollow Mirror  
Handle  
Ø 8 mm



**AG3-631**  
Hollow Mirror  
Handle  
Ø 10 mm



**AG3-632**  
Mirror Handle  
Solid  
Ø 6 mm



**AG3-633**  
Mirror Handle  
Solid  
Ø 6 mm



**AG3-634**  
Mirror Handle  
Solid Octagonal  
Ø 6 mm



**AG3-635**  
Mirror Handle  
Stem  
with Rule  
35mm



**AG3-636**  
Mirror Handle  
Solid  
Stem with  
Rule 35mm



**AG3-637**  
Cone-Socket  
Solid Octagonal  
Ø 6 mm



**AG3-638**  
Cone-socket  
Solid  
Ø 6 mm



**AG3-639**  
Cone-socket  
Hexagonal  
Handle  
Ø 6 mm

Cone-Socket Mirror Handle

# EXPLORERS

- Зонды
  - Sondes
  - Zahnsonden
- Зонди
  - Sondas
  - المستكشرون

Examination kit Set of 3 Pieces



**AG3-640** Probe  
**AG3-641** Mirror  
**AG3-642** College Forcep  
15cm



Examination Set of 4 Pieces



**AG3-643** Exp,23/17-A  
**AG3-644** Excavators  
**AG3-645** Tweezers  
**AG3-646** Mouth Mirror

**AG3-647**

First Aid Examination Set of 3 Pieces



**AG3-648**

First Aid Examination Set of 3 Pieces



**AG3-649**

First Aid Examination Set of 3 Pieces



**AG3-650**

First Aid Examination Set of 3 Pieces



## TWEEZERS

- Пинцеты
- Précettes - Brucelles
- Zahnpinzetten

- Пинцети
- Pinzas para algodón
- ملاقط



**AG3-651**  
Surgical  
11.5cm



**AG3-652**  
London College  
15cm



**AG3-653**  
Semken Taylor  
Str.



**AG3-654**  
Semken Taylor  
Cvd.



**AG3-655**  
Meriam  
16cm



**AG3-656**  
Dressing  
14cm



**AG3-657**  
Semken Taylor  
1x2 Straight



**AG3-658**  
Semken Taylor  
1x2 Curved



**AG3-659**  
Gilles  
15cm 1x2



**AG3-660**  
14cm 1x2



**AG3-661**  
Perry  
13cm



**AG3-662**  
Atraumatic  
15cm Cvd.



**AG3-663**  
Atraumatic  
15cm Str.



**AG3-664**  
College with Lock  
15cm Cvd.



**AG3-665**  
Gerald  
17.5cm



**AG3-666**  
with lock  
15cm



**AG3-667**  
Atraumatic  
17.5cm

## TWEEZERS

- Пинцеты
- Précelles - Brucelles
- Zahnpinzetten

- Пинцети
- Pinzas para algodón
- ملاقط



**AG3-668**  
Adson-TC  
12cm



**AG3-669**  
Adson-TC  
12cm 1x2



**AG3-670**  
Adson-TC  
15cm 1x2



**AG3-671**  
Adson  
12cm



**AG3-672**  
Adson  
12cm 1x2



**AG3-673**  
Adson  
15cm 1x2



**AG3-674**  
Adson Brown  
12cm



**AG3-675**  
Crane Kaplan  
15cm



**AG3-676**  
Crane Kaplan  
15cm



**AG3-677**  
Crane Kaplan  
15cm



**AG3-678**  
Hemingway  
15cm



**AG3-679**  
Miller  
15cm Str.



**AG3-680**  
Miller  
15cm Cvd.



**AG3-681**  
Dressing  
Tweezer  
14.5cm



**AG3-682**  
College  
Curved  
Tweezer  
Tip 15cm



**AG3-683**  
Maryam  
Tweezers  
15cm



**AG3-684**  
College  
Tweezer  
15cm



**AG3-685**  
Perry  
Tweezer  
12.5cm



**AG3-686**  
Self-locking  
Tweezer  
15cm

# EXPLORERS

- Зонды
  - Sondes
  - Zahnsonden
- Зонди
  - Sondas
  - المستكشفين

Single Ended Probe Solid Handle 4.5mm Length 150mm



Explorers-Single-End

Double-Ended Explorers

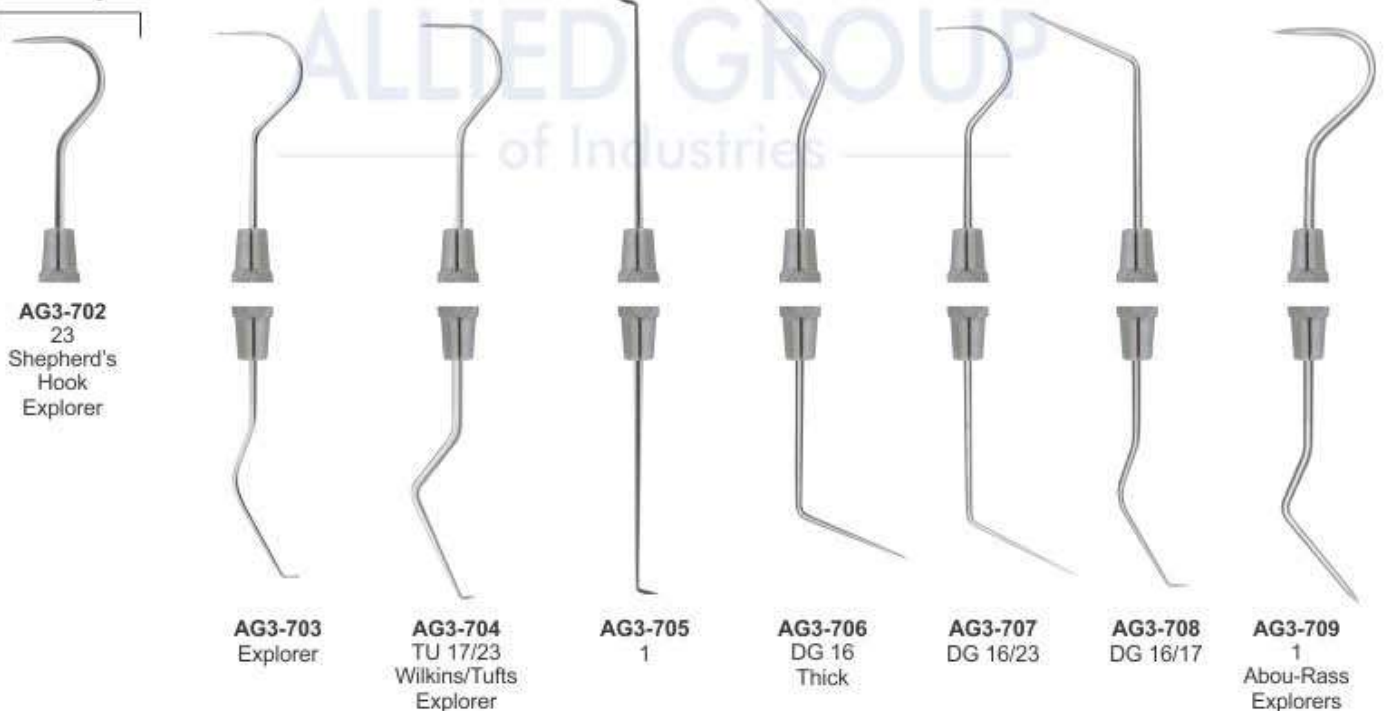



# EXPLORERS

- Зонды
  - Sondes
  - Zahnsonden
- Зонди
  - Sondas
  - المستكشفين

Probes Double Ended 6mm, length 170mm



**AG3-710**  
Williams



**AG3-711**  
23/UNC1  
university of north  
carolina Explorer



**AG3-712**  
Goldman Fox  
Fig.17



**AG3-713**  
University  
of Michigan  
Fig.17



**AG3-714**  
Williams  
Fig.17



**AG3-715**  
Goldman Fox  
Fig.16



**AG3-716**  
University  
of Michigan  
Fig.16



**AG3-717**  
Williams  
Fig.16

Pointed Probes Double Ended Handle 6mm, length 170mm



**AG3-718**  
Goldman Fox  
Williams



**AG3-719**  
Goldman Fox  
Merrit B



**AG3-720**  
Goldman Fox  
University of  
Michigan



**AG3-721**  
University  
of Michigan  
Fig.23



**AG3-722**  
Williams  
Fig.23











# EXPLORERS

- Зонды
  - Sondes
  - Zahnsonden
- Зонди
  - Sondas
  - المستكشفين

EXPLORERS INSTRUMENTS SOLID HANDLE 6MM, LENGTH 170MM

## PLUGGERS



|   |   |   |   |
|---|---|---|---|
| <p>.50</p>  <p>.75</p> <p><b>AG3-724</b><br/>5/7<br/>21mm</p>    | <p>1.00</p>  <p>1.15</p> <p><b>AG3-725</b><br/>9/11<br/>21mm</p> | <p>.50</p>  <p>.60</p> <p><b>AG3-726</b><br/>1/2<br/>Root Canal<br/>Plugger</p> | <p>.80</p>  <p>1.10</p> <p><b>AG3-727</b><br/>3/4<br/>Root Canal<br/>Plugger</p> |
| <p>.45</p> <p><b>AG3-723</b><br/>1/3<br/>21mm</p>   | <p>.20</p>  <p><b>AG3-728</b><br/>MA57<br/>27mm</p>          | <p>.25</p>  <p><b>AG3-729</b><br/>GP3<br/>30mm</p>                           |   |
| <p>.30</p>  <p><b>AG3-730</b><br/>ISO<br/>Size 30<br/>24mm</p> | <p>.40</p>  <p><b>AG3-731</b><br/>ISO<br/>Size 40<br/>24mm</p> | <p>.50</p>  <p><b>AG3-732</b><br/>ISO<br/>Size 50<br/>24mm</p>                 | <p>.60</p>  <p><b>AG3-733</b><br/>ISO<br/>Size 60<br/>24mm</p>                 |

# PERIODONTAL PROBES

- Зонды пародонтологические
  - Sondes paradontales
  - sonde parodontali
- зонди пародонтологічні
  - Sondas paradontales
  - المسابر اللثة

## SPREADERS

## HEAT CARRIERS



## HEAT CARRIERS



**AG3-734**  
ISO  
Size 30  
24mm

## PERIODONTAL PROBES

- Зонды пародонтологические
- Sondes paradontales
- sonda parodontali
- зонди пародонтологічні
- Sondas paradontales
- المسابير اللثة

### ENDODONTICS INSTRUMENTS

#### ANTERIOR



#### LUKS

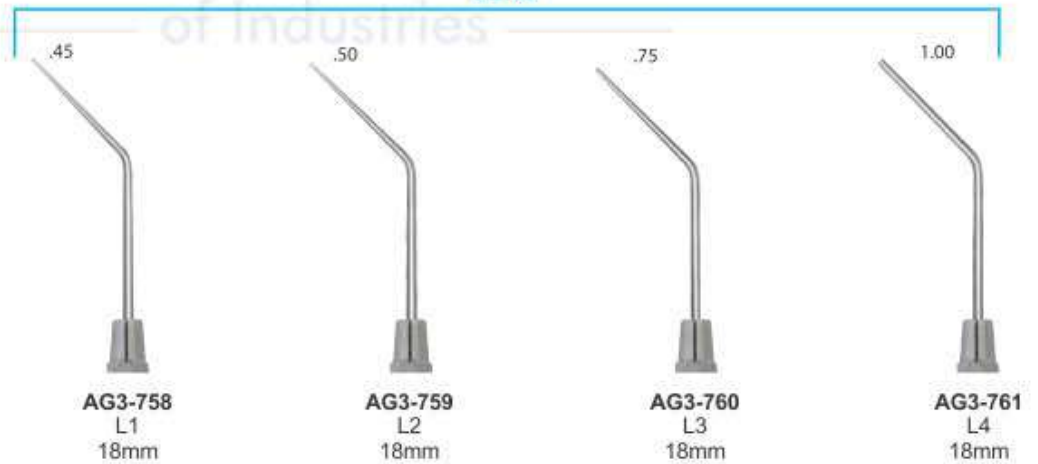

# SCALER



**AG3-762**  
Gracey Curettes 1/2



**AG3-763**  
Gracey Curettes 3/4



**AG3-764**  
Gracey Curettes 5/6



**AG3-765**  
Gracey Curettes 7/8



**AG3-766**  
Gracey Curettes 9/10

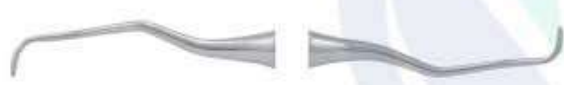

**AG3-767**  
Gracey Curettes 11/12



**AG3-768**  
Gracey Curettes 13/14



**AG3-769**  
Gracey Curettes 1/2



**AG3-770**  
Gracey Curettes 3/4



**AG3-771**  
Gracey Curettes 5/6



**AG3-772**  
Gracey Curettes 7/8



**AG3-773**  
Gracey Curettes 9/10



**AG3-774**  
Gracey Curettes 11/12



**AG3-775**  
Gracey Curettes 13/14



# SCALER

## GRACEY MINI FIVE

Hollow Handle 9.5mm, Length 170mm Ceramic Coated Handle



**AG3-777**  
Fig. 3/4 Gracey 3M



**AG3-778**  
Fig. 5/6 Gracey 3M



**AG3-779**  
Fig. 7/8 Gracey 3M  
Buccal and lingual/  
Palatal surfaces



**AG3-780**  
Fig. 11/12 Gracey 3M  
Mesial



**AG3-781**  
Fig. 13/14 Gracey 3M  
Distal

**AG3-776**  
Fig. 1/2  
Gracey 3m



## GRACEY AFTER FIVE

Hollow Handle 9.5mm, Length 170mm Ceramic Coated Handle



**AG3-783**  
Gracey 3/4 AF



**AG3-784**  
Gracey 5/6 AF



**AG3-785**  
Gracey 7/8 AF



**AG3-786**  
Gracey 11/12 AF



**AG3-787**  
Gracey 13/14 AF

**AG3-782**  
Gracey  
1/2 AF



Gracey Curettes



$\frac{3...1}{3...1} | \frac{1...3}{1...3}$  **AG3-788** Fig. 1/2 GR - Gracey  
Buccal surfaces



$\frac{5...1}{5...1} | \frac{1...5}{1...5}$  **AG3-789** Fig. 3/4 GR - Gracey  
Lingual/Palatal surfaces



$\frac{5...1}{5...1} | \frac{1...5}{1...5}$  **AG3-790** Fig. 5/6 GR - Gracey



$\frac{8...4}{8...4} | \frac{4...8}{4...8}$  **AG3-791** Fig. 7/8 GR - Gracey  
Buccal and lingual/  
palatal surfaces



$\frac{8...4}{8...4} | \frac{4...8}{4...8}$  **AG3-792** Fig. 9/10 GR - Gracey  
Buccal and lingual/  
palatal surfaces more angled



$\frac{8...4}{8...4} | \frac{4...8}{4...8}$  **AG3-793** Fig. 11/12 GR - Gracey  
Mesial



$\frac{8...4}{8...4} | \frac{4...8}{4...8}$  **AG3-794** Fig. 13/14 GR - Gracey  
Distal



$\frac{8...4}{8...4} | \frac{4...8}{4...8}$  **AG3-795** Fig. 15/16 GR - Gracey  
Mesial



$\frac{8...4}{8...4} | \frac{4...8}{4...8}$  **AG3-796** Fig. 17/18 GR - Gracey  
Distal

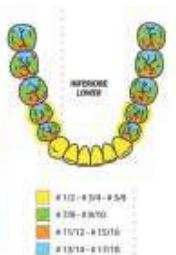
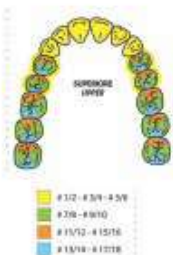

## SCALER

### Sickle Scalars



AG3-797 Fig. U15/33 - Towner-Jaquette



AG3-798 Fig. U15/30 - Towner-Jaquette



AG3-799 Fig. H5/33



AG3-800 Fig. H6/H7



AG3-801 Fig. 30/33 - Jaquette



AG3-802 Fig. T2/T3 - Taylor



AG3-803 Fig. 204



AG3-804 Fig. 204S



AG3-805 Fig. 11/12 - MC - McCall  
Mesial



AG3-806 Fig. 13/14 - MC - McCall  
Distal

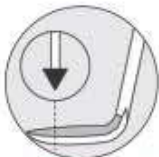

**Straight and curved sickle scalars**

Feature: 2 cutting edges curved facial component tipped ends



**Universal curettes**

are characterized by an angle of 90° between the terminal stem and the cutting component.

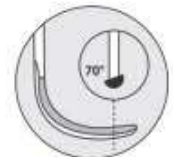

**Gracey curettes**

are characterized by an angle of 70° between the terminal stem and the cutting component.



Universal Curettes



AG3-807 Fig. 13S/14S - MC - McCall



AG3-808 Fig. 17S/18S - MC - McCall  
Distal



AG3-809 Fig. M23



AG3-810 Fig. 204SD



AG3-811 Fig. YG7/8-Younger Good



AG3-812 Fig. L 1/2 - Langer



AG3-813 Fig. L 3/4 - Langer



AG3-814 Fig. L 5/6 - Langer



AG3-815 Fig. M 23A



AG3-816 Fig. M 23B

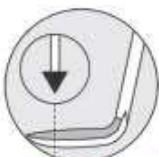

**Straight and curved sickle scalers**

Feature: 2 cutting edges curved facial component tipped ends

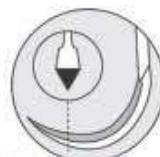

**Universal curettes**

are characterized by an angle of 90° between the terminal stem and the cutting component.

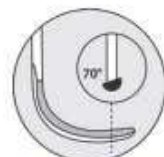

**Gracey curettes**

are characterized by an angle of 70° between the terminal stem and the cutting component.

Periodontal knives





0.9 MM

0.7 MM

Chisels  
Diamond coated margin trimmers

Thanks to the diamond-coated hand instruments the margins are evenly levelled.

## SCALER

### Margin trimmers



**AG3-835**  
1TH2 Hirt



**AG3-836**  
5TH6 Hirt



**AG3-837**  
3TH4 Hirt



**AG3-838**  
7TH8 Hirt

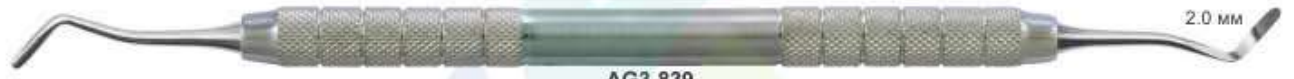

**AG3-839**  
62NS61

2.0 MM

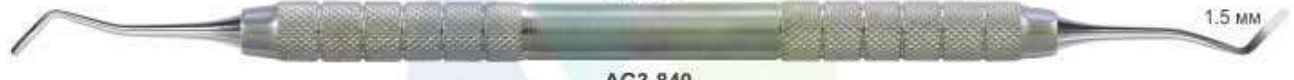

**AG3-840**  
37NS36

1.5 MM

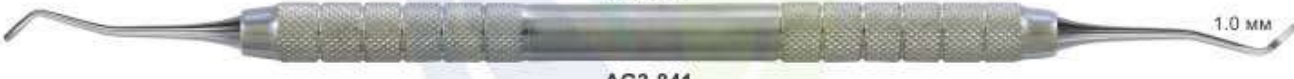

**AG3-841**  
66NS65

1.0 MM



**AG3-842**  
79CI180 Black



**AG3-843**  
77CI78 Black



**AG3-844**  
279CI280 Black



**AG3-845**  
277CI278 Black



**AG3-846**  
179CI180 Black



**AG3-847**  
177CI178 Black

CHISELS



AG3-848  
1/2 Werdelstaedt



AG3-849  
3/4 Werdelstaedt



AG3-850  
7 Straight



AG3-851  
5/6 Straight



AG3-852  
7/10 Straight



AG3-853  
8/9 Binangle



AG3-854  
11/12 Binangle

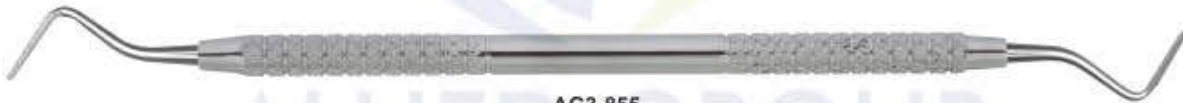

AG3-855  
40/41 Binangle

Tartar Remover Instruments Solid Handle Ø 6 mm



AG3-856  
Fig. 1



AG3-857  
Fig. 1L  
Left



AG3-858  
Fig. 1R  
Right



AG3-859  
Fig. 2L  
left



AG3-860  
Fig. 2R  
Right



AG3-861



AG3-862



AG3-863

## BURNISHERS CONSERVATIVE TREATMENT



# FILLING INSTRUMENTS CONSERVATIVE TREATMENT



## FILLING INSTRUMENTS CONSERVATIVE TREATMENT





# BURNISHERS CONSERVATIVE TREATMENT

## Ball Burnishers



## Hatches



## COMPOSITE INSTRUMENTS

Spatulas rounded and sharp

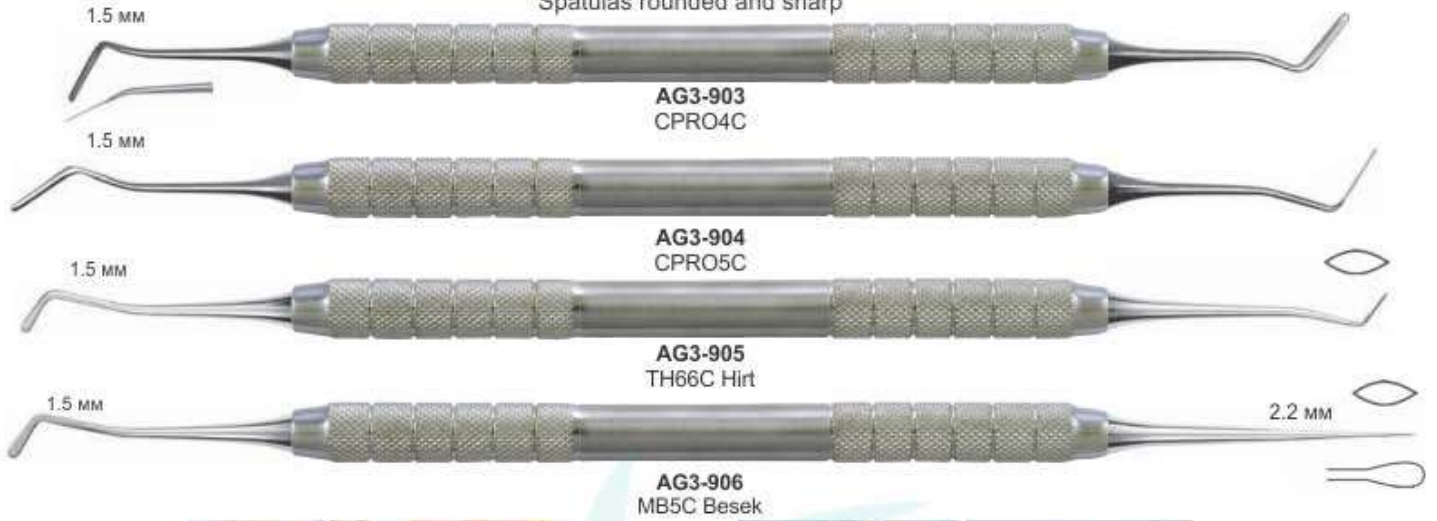

Spatulas Blade Thickness 0.22 mm

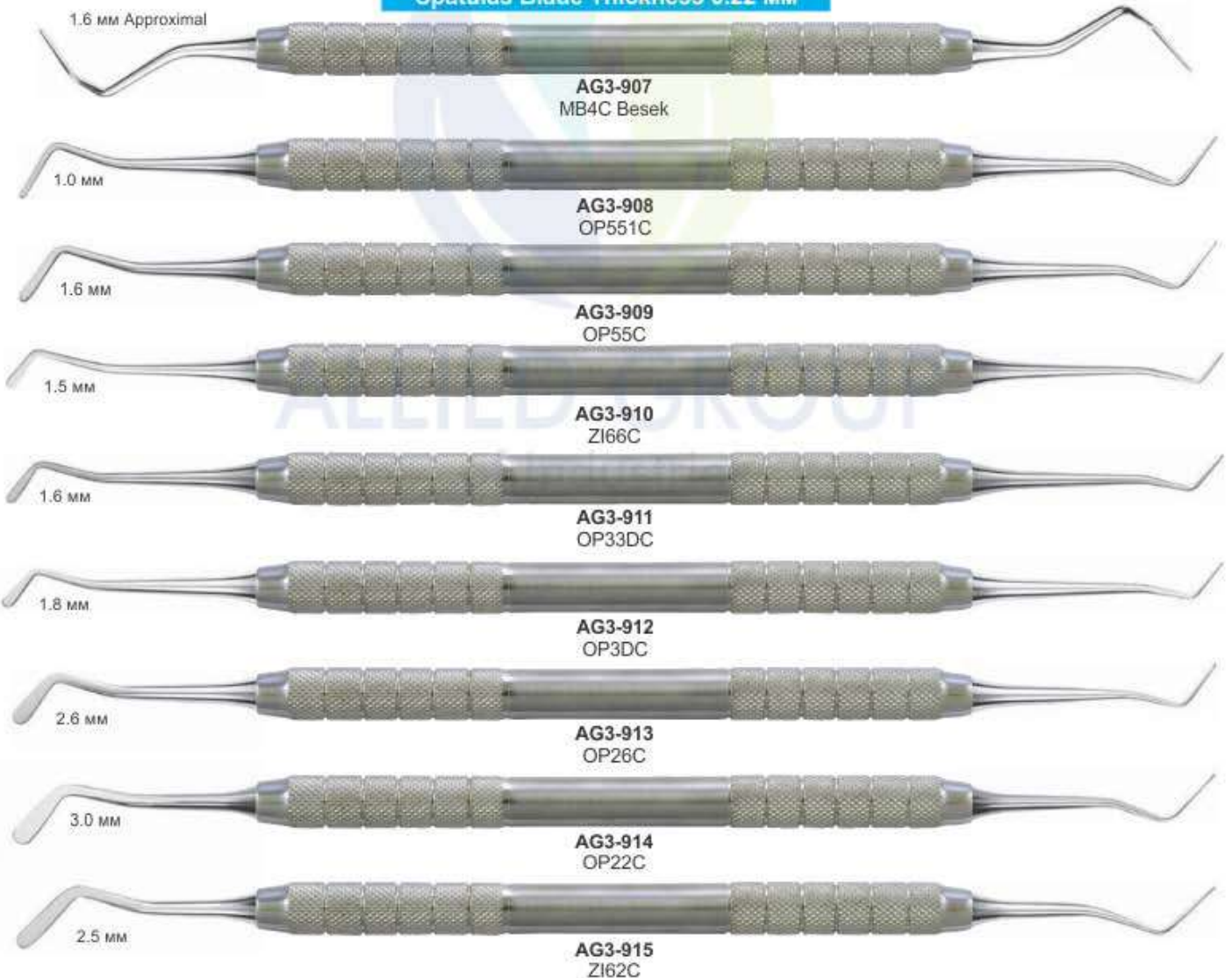

# COMPOSITE INSTRUMENTS

## Spatulas

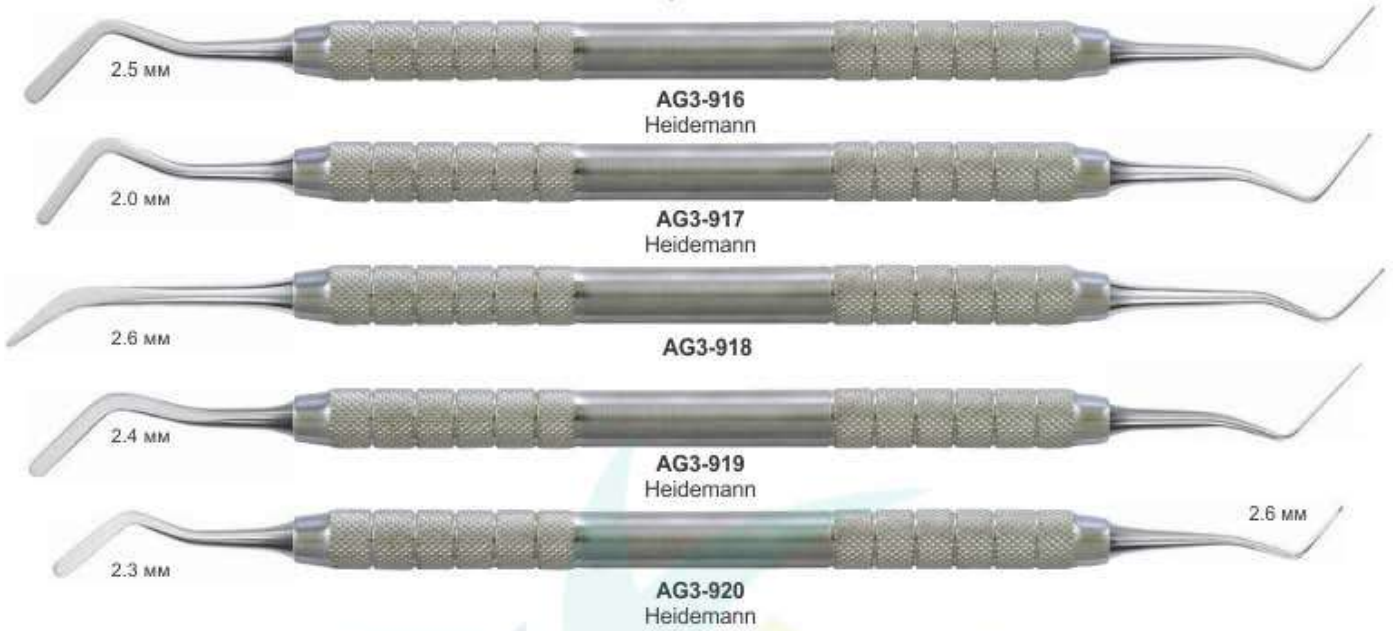

## Spatulas-Pluggers



## EXCAVATOR INSTRUMENTS

Water drop Our excavators have particularly sharp blades, free of burrs and perfectly rounded.

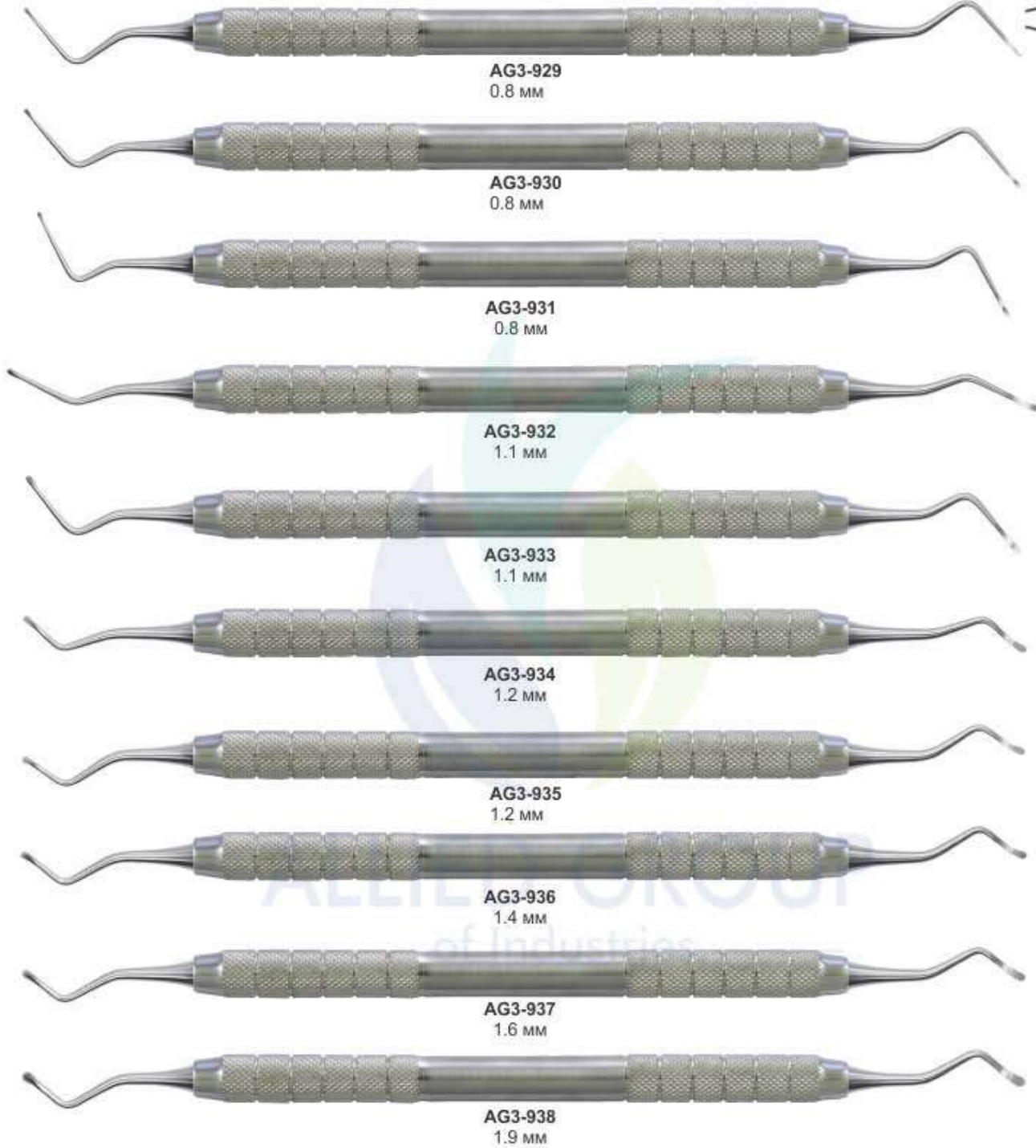

# FILLING INSTRUMENTS CONSERVATIVE TREATMENT



## COMPOSITE BALL PLUGGERS

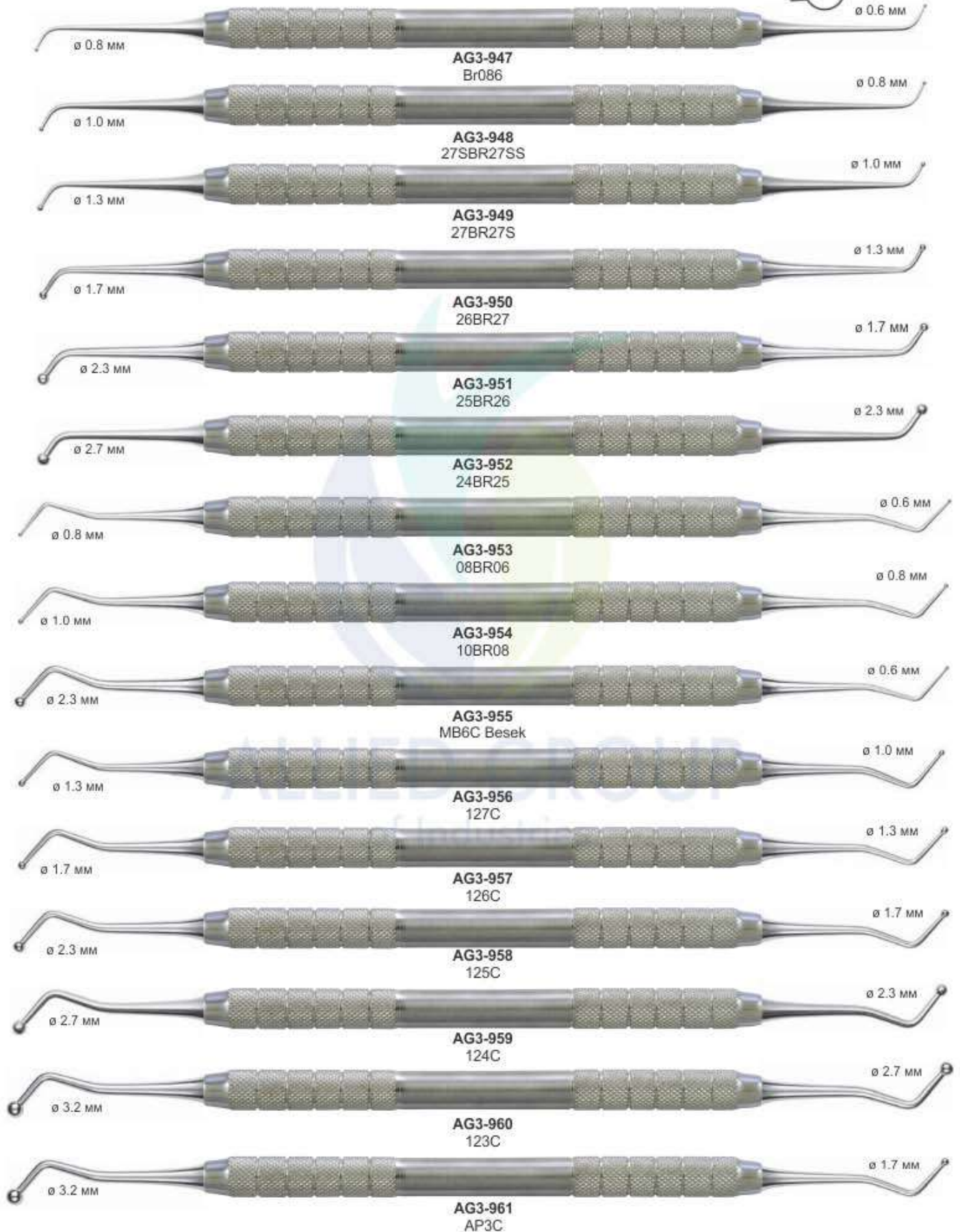

# FILLING INSTRUMENTS CONSERVATIVE TREATMENT

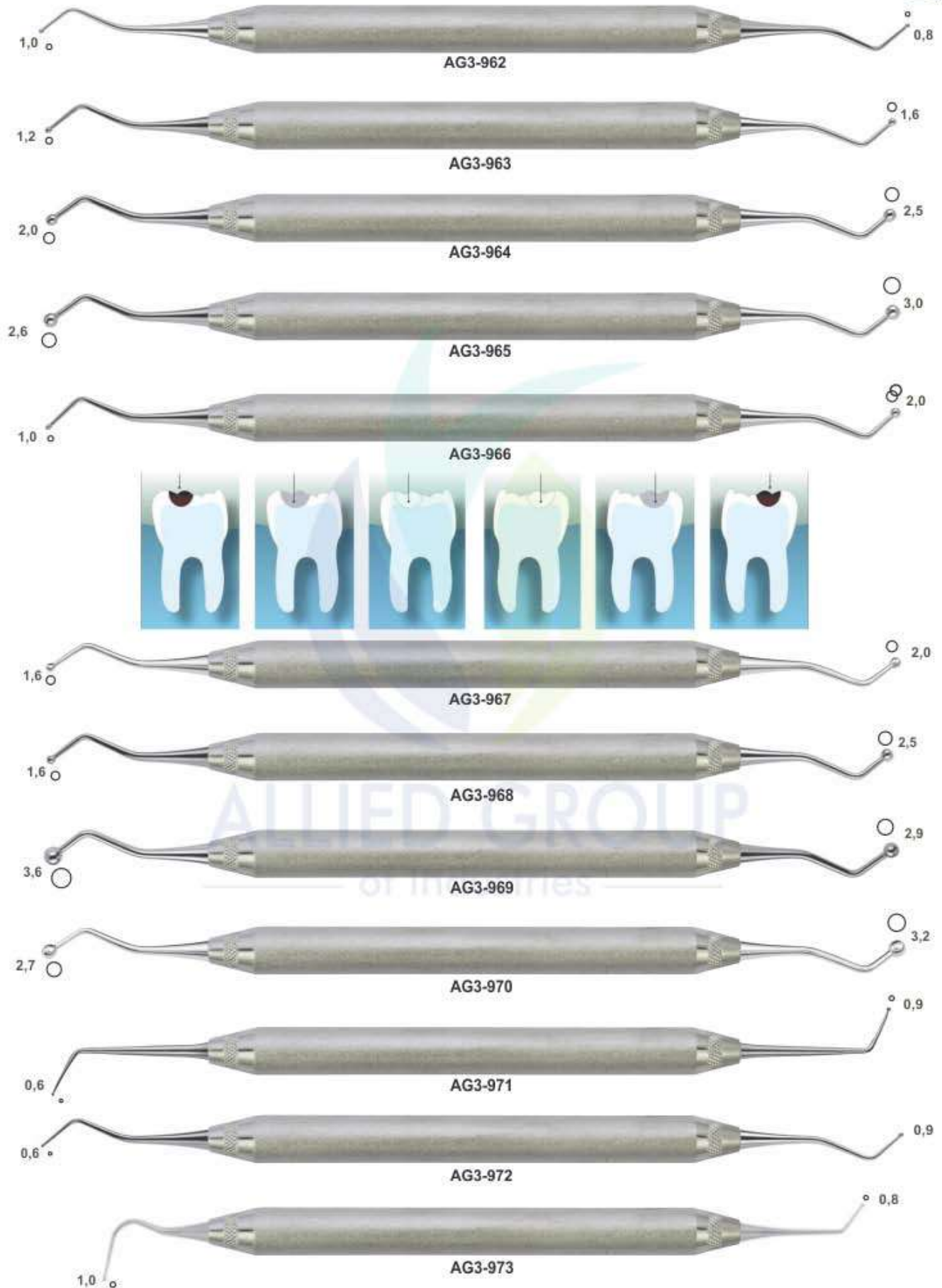

## FILLING INSTRUMENTS CONSERVATIVE TREATMENT





# FILLING INSTRUMENTS CONSERVATIVE TREATMENT



## FILLING INSTRUMENTS CONSERVATIVE TREATMENT



# FILLING INSTRUMENTS CONSERVATIVE TREATMENT



AG3-1005  
WILLIAMS



AG3-1006  
WILLIAMS



AG3-1007  
WILLIAMS



AG3-1008



AG3-1009



AG3-1010



AG3-1011



AG3-1012



AG3-1013



AG3-1014

## COMPOSITE PLUGGERS INSTRUMENTS

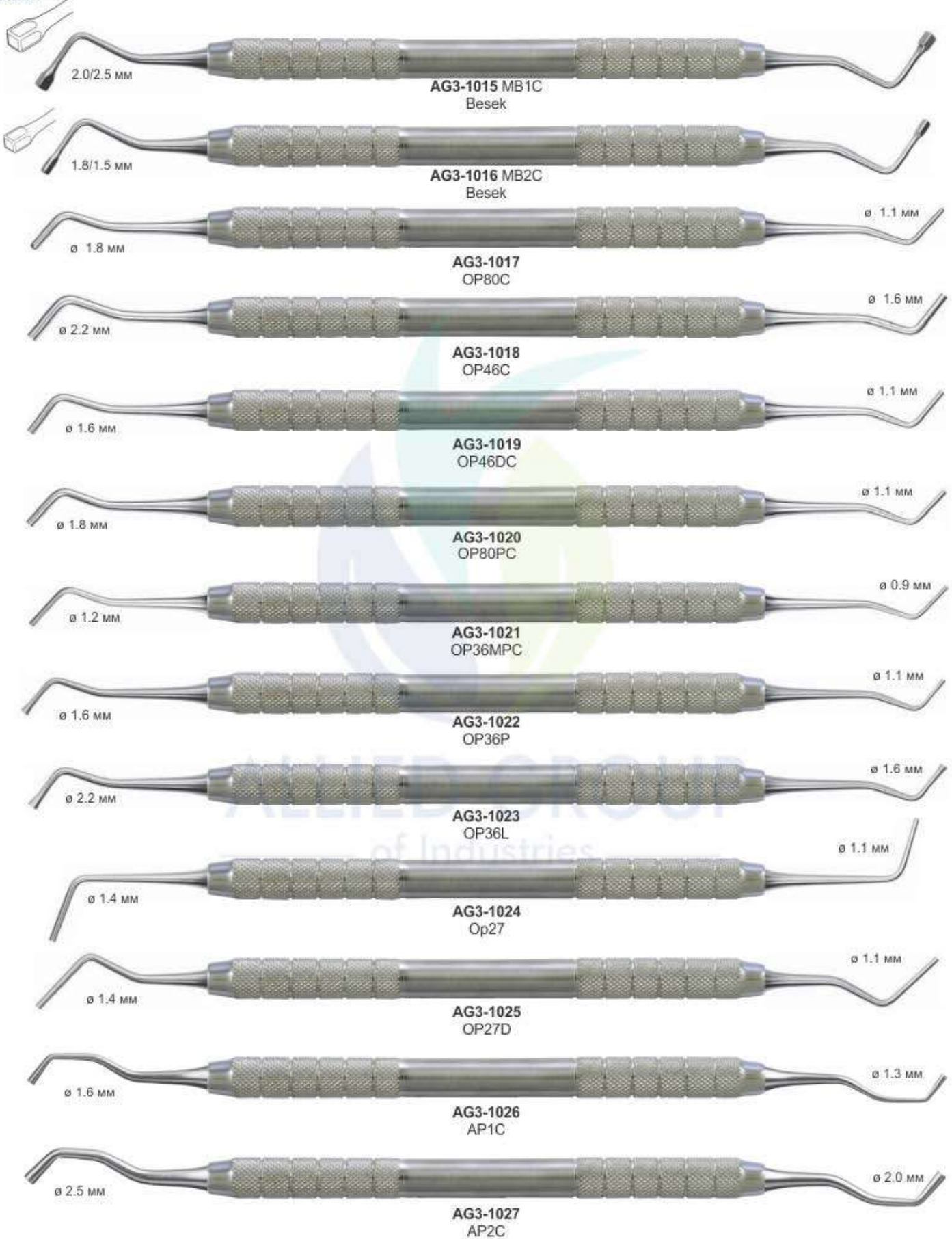

# COMPOSITE PLUGGERS INSTRUMENTS



## Serrated Pluggers



|          |  |          |
|----------|--|----------|
| Ø 0.9 MM |    | Ø 1.2 MM |
|          | <b>AG3-1034</b><br>OP36M   |          |
| Ø 1.1 MM |    | Ø 1.6 MM |
|          | <b>AG3-1035</b><br>OP36D   |          |
| Ø 1.6 MM |    | Ø 2.2 MM |
|          | <b>AG3-1036</b><br>Op36  |          |
| Ø 1.0 MM |    | Ø 1.7 MM |
|          | <b>AG3-1037</b><br>Op52  |          |
| Ø 2.2 MM |   | Ø 2.6 MM |
|          | <b>AG3-1038</b><br>Zi51  |          |
| Ø 1.8 MM |  | Ø 2.2 MM |
|          | <b>AG3-1039</b><br>Op44  |          |
| Ø 1.7 MM |  | Ø 2.6 MM |
|          | <b>AG3-1040</b><br>1BR2  |          |
| Ø 2.6 MM |  | Ø 3.6 MM |
|          | <b>AG3-1041</b><br>2BR3  |          |

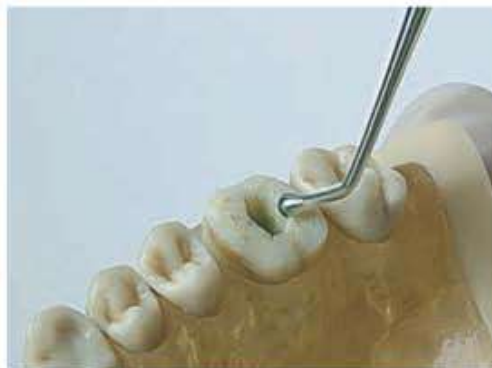

# COMPOSITE MODELLING INSTRUMENTS



AG3-1042 MF2C  
Fuzzi



AG3-1043  
Pj4



AG3-1044 MB3C  
Besek



AG3-1045  
HZ3C



AG3-1046  
CPRO3C



AG3-1047 Mo1  
Monari



AG3-1048 TH28C  
Hirt



AG3-1049  
HZ25C



AG3-1050  
Ck10



AG3-1051  
CK28BC



AG3-1052 Op37  
Carver



AG3-1053  
28BR29

## EXCAVATORS

### Round excavators

- Cariology**
- for the removal of softened, carious dentin
  - for the removal of temporary fillings
- Surgery**
- to sever the periodontal ligament prior to extraction
  - for the removal of granulation tissue after extraction
- Design: Round working end Curved cutting edge



Round Excavator, 1.0 mm  
AG3-1054



Round Excavator, 1.5 mm  
AG3-1055



Round Excavator, 2.0 mm  
AG3-1056

### Triple-angled back action excavators



Triple-angled Back Action Excavator, 1.0 mm  
AG3-1057



Triple-angled Back Action Excavator, 1.5 mm  
AG3-1058



Triple-angled Back Action Excavator, 2.0 mm  
AG3-1059



Triple-angled Back Action Excavator, 3.5 mm  
AG3-1060





# FILLING INSTRUMENTS

- Инструменты для реставрации
- Instruments pour plombage
- Füllungsinstrumente (mit Kontrawinkel)
- Инструменти для реставрації
- Instrumentos para obturaciones
- ملء الصكوك

COMPOSITE/PLASTIC FILLING INSTRUMENTS SOLID HANDLE 6MM, LENGTH 170MM

BLACK

PLUGGERS/CONDENSERS

Hollenback

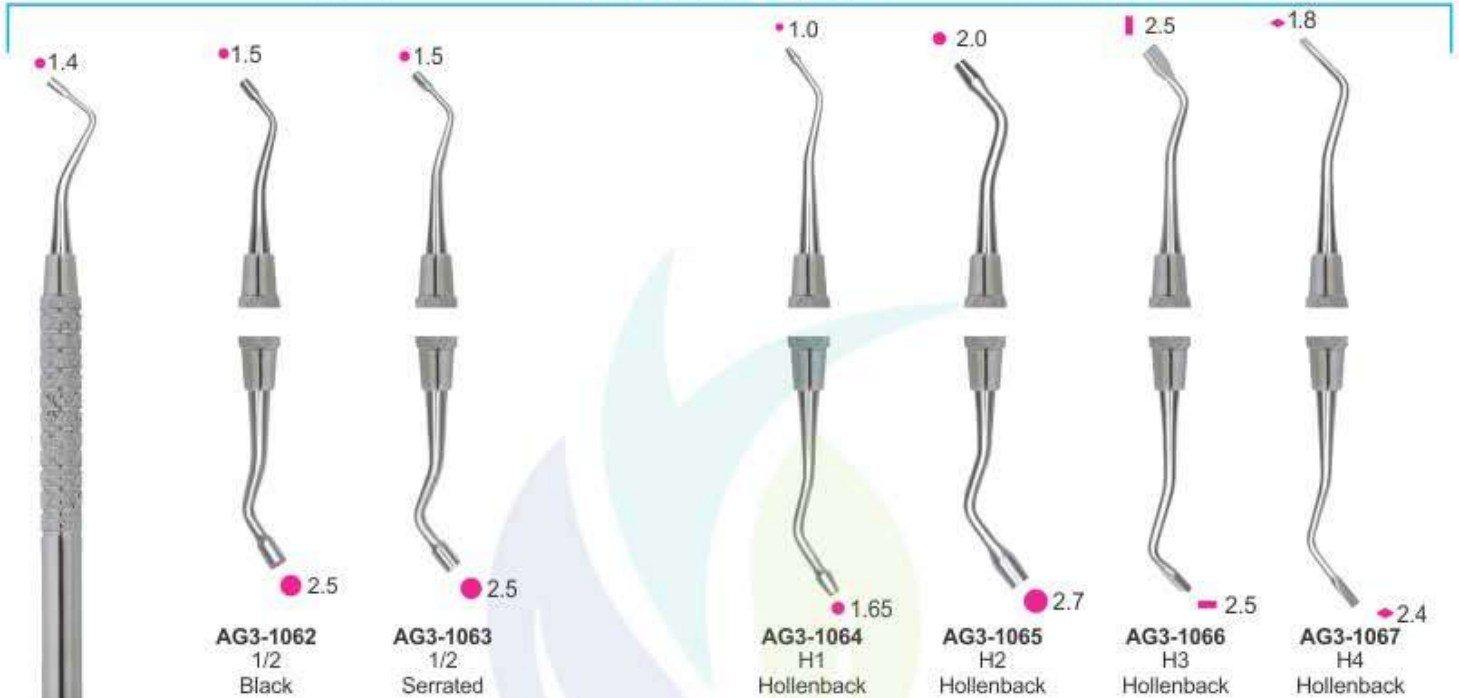

MARQUETTE CONDENSER

MORTONSON

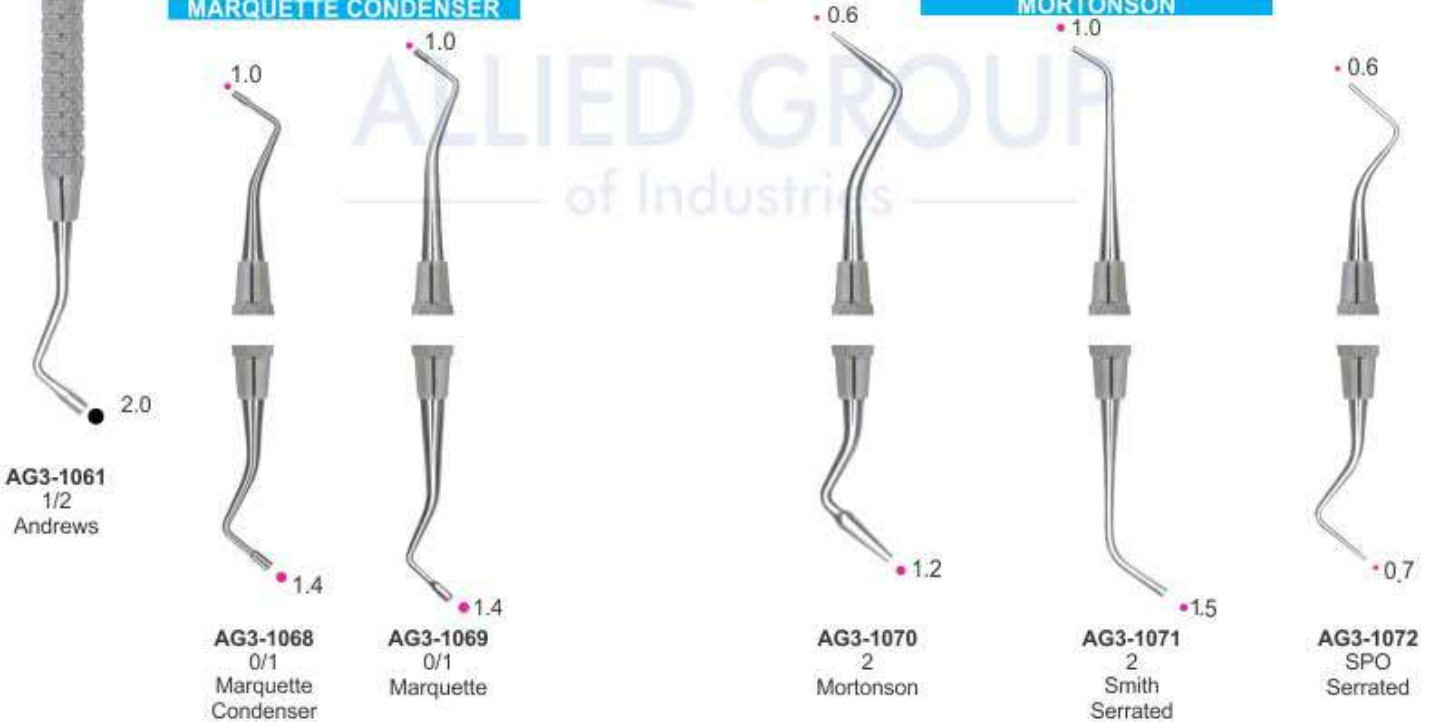

## FILLING INSTRUMENTS

- Инструменты для реставрации
- Instruments pour plombage
- Füllungsinstrumente (mit Kontrawinkel)
- Инструменти для реставрації
- Instrumentos para obturaciones
- ملء الصمغ

### RESTORATIVE INSTRUMENTS SOLID HANDLE 6MM, LENGTH 170MM Back Action Filling Instruments

#### Tanner Filling Instruments

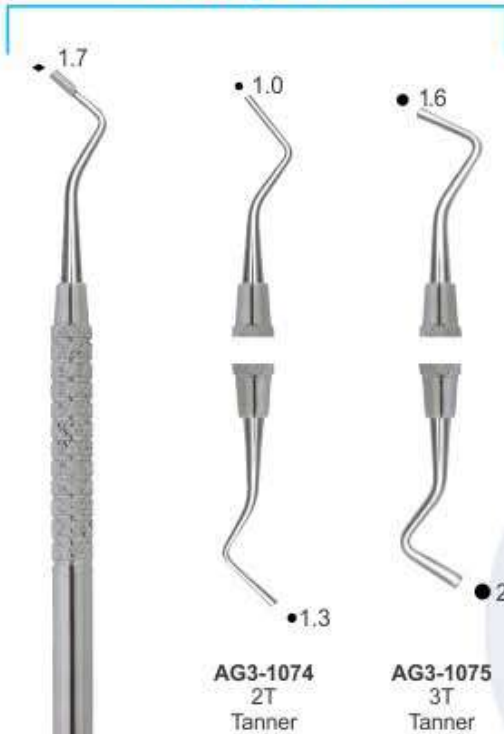

AG3-1074  
2T  
Tanner

AG3-1075  
3T  
Tanner

AG3-1076  
9/10  
Back Action

AG3-1077  
11/12  
Back Action

AG3-1078  
153  
English Pattern  
Serrated

AG3-1079  
153  
English Pattern  
Serrated

#### BURNISHERS

##### BALL

##### BEAVERTAIL

##### ACORN

##### LADMORE

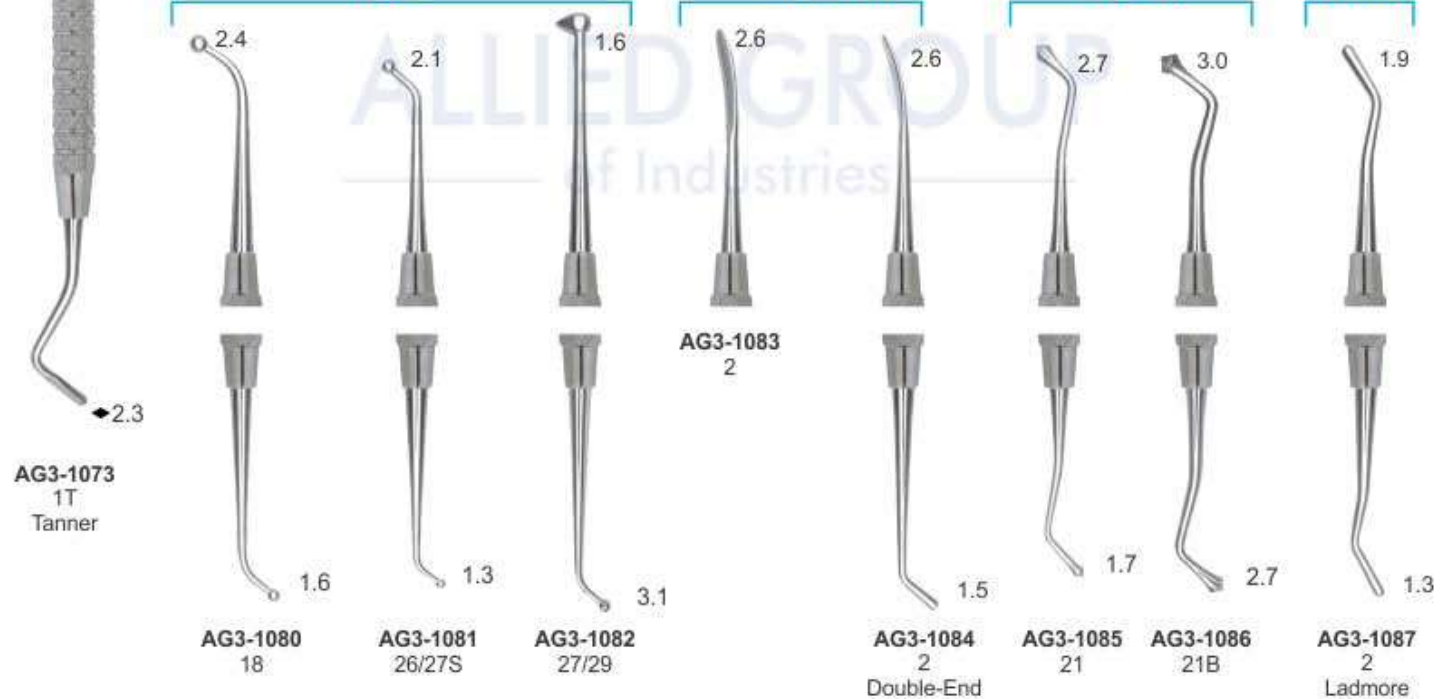

AG3-1073  
1T  
Tanner

AG3-1080  
18

AG3-1081  
26/27S

AG3-1082  
27/29

AG3-1083  
2

AG3-1084  
2  
Double-End

AG3-1085  
21

AG3-1086  
21B

AG3-1087  
2  
Ladmore

## CARVERS INSTRUMENTS

- Инструменты для реставрации
- Instruments a modeler
- Modellierinstrumente
- Инструменти для реставрації
- Instrumentos para modelar
- أدوات تقطیع

### P.K. THOMS WAXING INSTRUMENTS SOLID HANDLE 6mm



**AG3-1095**  
Composite Instruments Blue  
Titanium with Cassettes



**AG3-1094**  
P.k. Thomas Waxing Instruments Kit

### COMPOSITE INSTRUMENTS TITANIUM BLUE ENDODONTIC

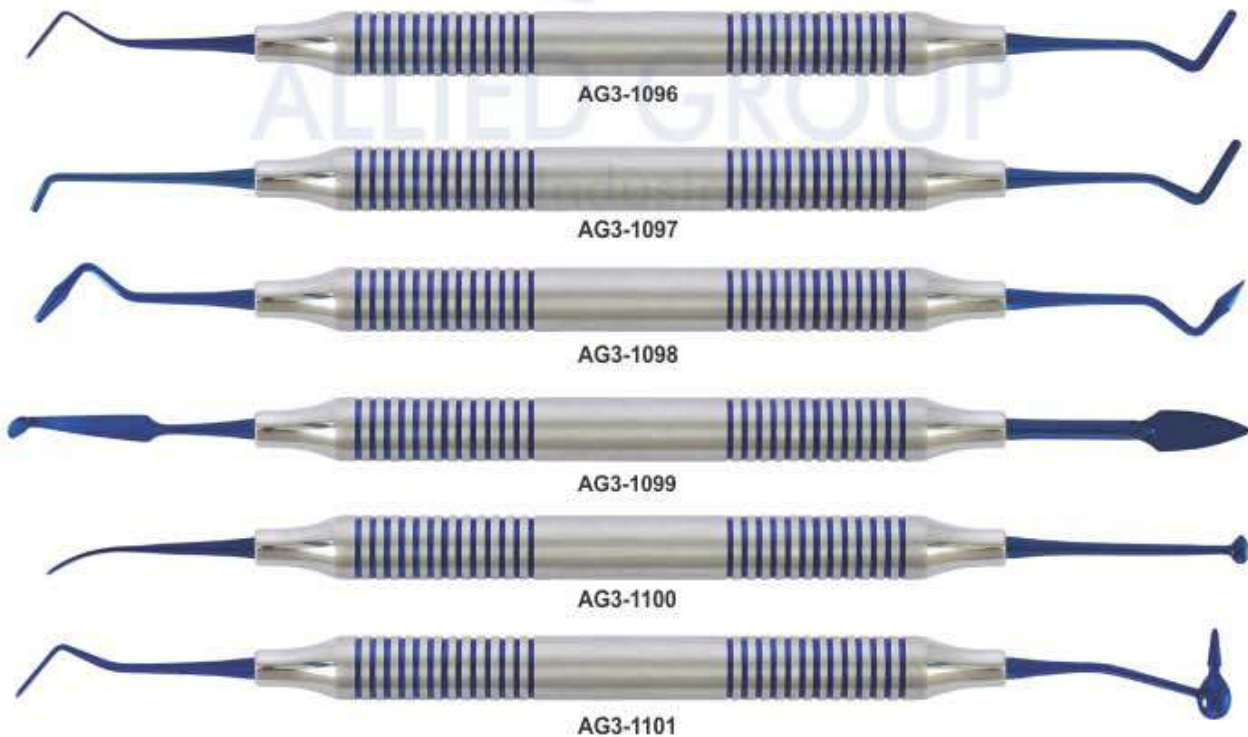

## CARVERS INSTRUMENTS

- Инструменты для реставрации
- Instruments a modeler
- Modellierinstrumente
- Инструменти для реставрації
- Instrumentos para modelar
- أدوات تقطیع



AG3-1102



AG3-1103

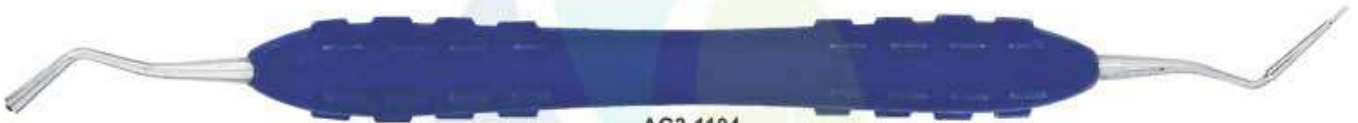

AG3-1104



AG3-1105



AG3-1106



Cassette For 5 Instruments  
AG3-1107

## FILLING INSTRUMENTS

- Инструменты для реставрации
- Instruments pour plombage
- Füllungsinstrumente (mit Kontrawinkel)
- Инструменти для реставрації
- Instrumentos para obturaciones
- ملء الصكونك

### FILLING INSTRUMENTS (Gold Pointed) SOLID HANDLE 6MM, LENGTH 170MM



AG3-1108 1.5mm / 1.5mm

AG3-1109 2.0mm / 2.0mm

AG3-1110 2.0mm / 2.0mm

AG3-1111 2.5mm / 2.5mm

AG3-1112 1.3mm / 0.9mm

AG3-1113 1.6mm / 1.3mm

AG3-1114 2.4mm / 1.8mm

AG3-1115 2.4mm / 2.0mm

AG3-1116 1.3mm / 1.5mm

AG3-1117 1.8mm / 1.2mm

Filling instrument, spatula 6 mm solid handle, length 170 mm,

Filling instrument 6 mm length 175 mm,

Filling instrument, ball 6 mm length 170 mm,

Filling instrument, ball / spatula 6 mm length 175 mm,

Filling instrument, plan / plan 6 mm length 165 mm,

## COMPOSITE FILLING INSTRUMENTS

- Инструменты для реставрации
- Instruments pour plombage
- Füllungsinstrumente (mit Kontrawinkel)
- Инструменти для реставрації
- Instrumentos para obturaciones
- ملء الصكوك

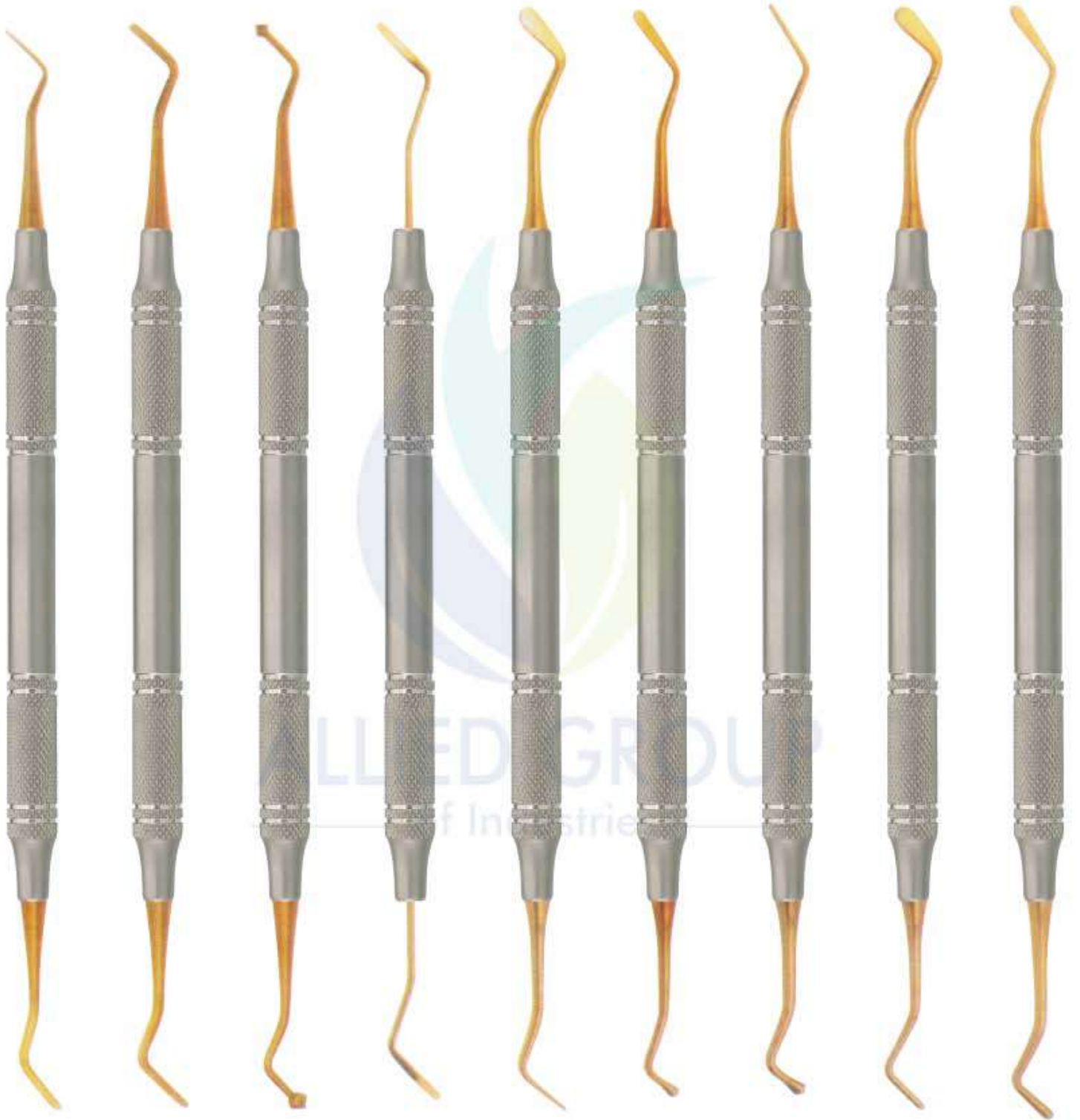

AG3-1118

AG3-1119

AG3-1120

AG3-1121

AG3-1122

AG3-1123

AG3-1124

AG3-1125

AG3-1126

## COMPOSITE FILLING INSTRUMENTS

- Инструменты для реставрации
- Instruments pour plombage
- Füllungsinstrumente (mit Kontrawinkel)
- Инструменти для реставрації
- Instrumentos para obturaciones
- ملء الصكوك

### Composite Gold Tip Instruments



## MISCELLANEOUS PRODUCTS

- Прочие товары
  - Divers produits et services
  - Sonstige Produkte
- Інші товари
  - Varios Productos
  - المنتجات المتنوعة



**AG3-1138**  
X Ray Film Hangers



**AG3-1139**  
X Ray Film Hangers



**AG3-1140**  
X Ray Film Hangers



**AG3-1141**  
X Ray Film Hangers



**AG3-1142**  
X Ray Film Hangers



**AG3-1143**  
X Ray Film Hangers



**AG3-1144**  
X Ray Film Hangers

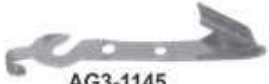

**AG3-1145**



**AG3-1146**



**AG3-1147**



Dissecting Set  
**AG3-1148** Set of 9 Pcs.  
**AG3-1149** Set of 11 Pcs.



**AG3-1150**  
Napkin Holder with Plastic Chain

**AG3-1151**  
Napkin holder with metal chain



**Mouth Props**  
**AG3-1152**  
Small

**Mouth Props**  
**AG3-1153**  
Medium

**Mouth Props**  
**AG3-1154**  
Large

### Key Rings



**AG3-1155**



**AG3-1156**



**AG3-1157**



**AG3-1158**



**AG3-1159**



**AG3-1160**



## CEMENT SPATULAS

- Шпатели для цемента
  - Spatules à ciment
  - Zementspatel
- Шпателі для цементу
  - Espátulas para cemento
  - ملاعق الإسمنت



## WAX KNIVES

- Ножи для воска
  - Couteaux a cire
  - Wachsmesser
- Ножи для воску
  - Cuchillos para cera
  - السكاكين الشمع

ALGINATE, PLASTER SPATULAS, WAX KNIVES PLASTER FOR KNIVES & PLASTER SHEAR



**AG3-1183**  
Wooden Handle  
Fig. 5  
21.5 cm



**AG3-1184**  
Wooden Handle  
Fig. 7  
19.5 cm curved



**AG3-1185**  
Wooden Handle  
Fig. 8  
20 cm curved



**AG3-1186**  
Wooden Handle  
Fig. 9  
22.5 cm curved



**AG3-1187**  
Hook Knives



**AG3-1188**  
Fig. 1  
Lessmann  
12.5 cm



**AG3-1189**  
Fig. 2  
Lessmann  
17 cm



**AG3-1190**  
Fig. 1  
with small spoon  
12.5 cm



**AG3-1191**  
Fig. 2  
with large spoon  
17 cm



**AG3-1192**  
Bacolite Handle  
Wax Knives,  
Small



**AG3-1193**  
Bacolite Handle  
Wax Knives,  
Large



**AG3-1194**  
Wooden Handle  
Wax Knives,  
Small



**AG3-1195**  
Wooden Handle  
Wax Knives,  
Large



**AG3-1196**  
Plaster Knife



**AG3-1197**  
Fig. 1  
17 cm



**AG3-1198**  
Fig. 3  
16 cm



**AG3-1199**  
Fig. 4  
16 cm



**AG3-1200**  
Special Inox  
19.5 cm

# ARTICULATORS

- Артикуляторы
- Articular
- Artikulations

- Артикулятори
- Articuler
- آرتیکو لاتورس



**AG3-1201**

**Technical Datas:**

Intercondylar distance  
condylar inclination  
Bennet angle  
Incisal table inclination  
Distance between mounting plates  
Weight  
Opening (item 5000)  
Opening (item 5010)

120 mm.  
fixed at 30°  
fixed at 7°  
10°  
85 mm.  
400 gr.  
125°  
180°



**AG3-1202**

**Technical Datas:**

Intercondylar distance  
condylar inclination  
Bennet angle  
Incisal table inclination  
Distance between mounting plates  
Weight  
Opening

110 mm.  
fixed at 30°  
fixed at 7°  
flat  
85 mm.  
450 gr.  
180°



**AG3-1203**

Stainless Steel Finishing  
**AG3-1204**  
Royal Blue



**AG3-1205**



**AG3-1206**



**AG3-1207**



**AG3-1208**



**AG3-1209**



**AG3-1210**



**AG3-1211**



**AG3-1212**



**AG3-1213**



**AG3-1214**  
Nakawalni  
Dental Laboratory  
Instrument

## DENTAL PHOTOGRAPHIC MIRRORS

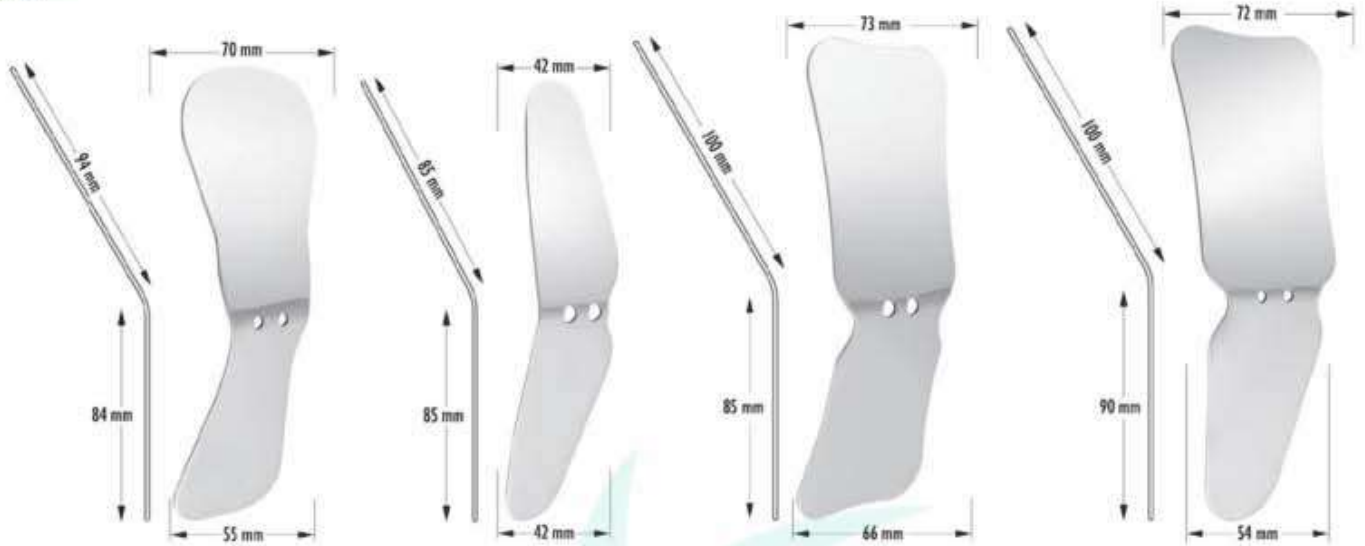

**AG3-1215** Adult Palatal /  
**AG3-1216** Child Palatal

**AG3-1217**  
Buccal

**AG3-1218** Adult Palatal /  
**AG3-1219** Child Palatal

**AG3-1220** Adult Palatal /  
**AG3-1221** Adult Buccal



**AG3-1222** Lingual upper /  
**AG3-1223** Lingual Lower

**AG3-1224** Adult Buccal /  
**AG3-1225** Child Buccal

**AG3-1226** Child Palatal /  
**AG3-1227** Child Buccal

**AG3-1228**  
Palatal-Adult

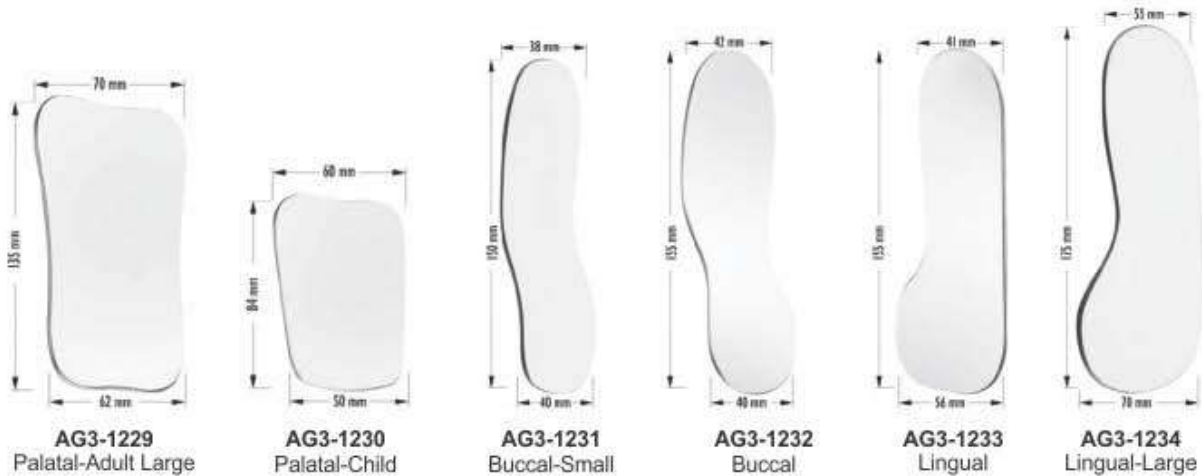

**AG3-1229**  
Palatal-Adult Large

**AG3-1230**  
Palatal-Child

**AG3-1231**  
Buccal-Small

**AG3-1232**  
Buccal

**AG3-1233**  
Lingual

**AG3-1234**  
Lingual-Large

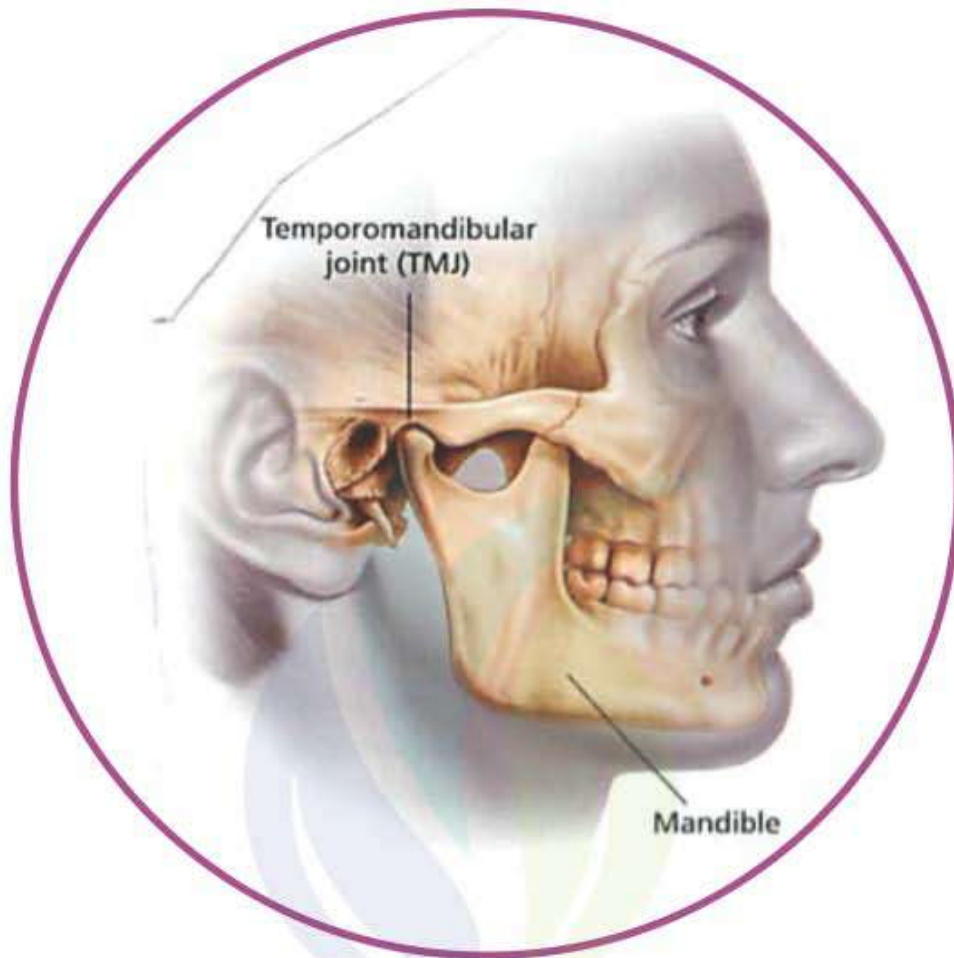

## RETRACTORS - MOUTH GAGS

- Роторасширители
- Ecarteurs - Ouvre-bouches
- Vestibulumabhalter / Mundspanner
- Роторозширювачі
- Separadores - Abre-bocas
- الكاشطات - الكمامات الفم



**AG4-1251**  
HMG  
Heister  
130mm



**AG4-1252**  
Mouth Gag Molt  
11 cm for (Children)



**AG4-1253**  
Mouth Gag Molt  
14 cm for (Adults)



**Sternberg Retractors**  
**AG4-1254** 140 mm  
**AG4-1255** 180 mm



**Columbia Retractor**  
**AG4-1256** 140 mm



**AG4-1257**  
Wangen Holder  
vestibule  
15 cm, with or without  
lip protection,



**AG4-1258**  
Wangen Holder  
vestibule 15 cm, with  
or without lip protection



**AG4-1259**  
Wangen Holder  
with dual  
function, 17 cm



**Weider Retractor**



**AG4-1260**  
140 mm



**AG4-1261**  
150 mm

## RETRACTORS - MOUTH GAGS

- Роторасширители
- Ecarteurs - Ouvre-bouches
- Vestibulumabhalter / Mundspanner
- Роторозширювачі
- Separadores - Abre-bocas
- الكاشطات-الكمامات الفم



Weitlaner  
Fig. 1  
AG4-1262 10.5cm  
AG4-1263 13.5cm



Weitlaner  
Fig. 2  
AG4-1264 10.5cm  
AG4-1265 13.5cm



**AG4-1266**  
Lip & Cheek Retractor  
Stainless Steel  
Double Ended



**AG4-1267**  
Simplex Retractor  
Stainless Steel  
Single Ended



Weitlander  
AG4-1268 11cm  
AG4-1269 13cm  
AG4-1270 15cm



**AG4-1274**  
Denhard  
12 cm



**AG4-1275**  
Roser-König  
16 cm



**AG4-1276**  
Roser-König  
19 cm



Jennings  
AG4-1271 11cm  
AG4-1272 13cm  
AG4-1273 15cm

## RETRACTORS

- Ранорасширители
  - Ecarteurs
  - Wundhaken
- Ранорозширювачі
  - Separadores
  - الكاشحات

**Wound, Bendable**  
Retractor, individually or as saving kit!



**AG4-1277**  
Cheek Retainer  
One-sided  
Long



**AG4-1278**  
Cheek Retainer  
One-sided  
Long



**AG4-1279**  
Cheek Retainer  
One-sided  
Long



**Ergo Grip  
Retractor**  
**AG4-1280** 24 cm  
ergonomic handle,



**Ivory Retractors**  
Width adjustable  
& fixable,  
**AG4-1281** 20 cm



**Bruenings Retractors**  
tongue depressors  
**AG4-1282** 19 cm



**Minnesota  
Retractors**  
**AG4-1283** 16 cm



**Ribbon Retractors**  
**AG4-1284** 20 cm  
easy to bend  
by hand,



**Bishop Retractors**  
retractor and tongue  
pushers Bishop with  
comfortable margin  
**AG4-1285** 16 cm



**Combination  
Retractors**  
**AG4-1286** 25 cm



## RETRACTORS

- Ранорасширители
  - Ecarteurs
  - Wundhaken
- Ранорозширювачі
  - Separadores
  - الكاشطات



**AG4-1287**  
Unique Retractors  
Length 175 mm  
angled 45°



**AG4-1288**  
Unique Retractors  
Length 175 mm  
angled 90°



**AG4-1289**  
Retractors  
16cm



**AG4-1290**  
Retractors  
19cm



**AG4-1291**  
Mini-Langenbeck  
Retractors  
16 cm, hooks 22 mm



**AG4-1292**  
US army Retractors  
21 cm, 2



**AG4-1293**  
ALM Retractor  
about 8 cm



**AG4-1294**  
Senn Mueller Retractor  
17 cm, hooks 22 mm

## RETRACTORS

- Ранорасширители
  - Ecarteurs
  - Wundhaken
- Ранорозширювачі
  - Separadores
  - الكاشحات



**AG4-1295**  
Langenbeck Retractors  
surgical-flat  
21 cm, hook  
30x16 mm



**AG4-1296**  
Langenbeck Retractors  
surgical-flat  
21 cm, hook  
42x11 mm



**AG4-1297**  
Langenbeck Retractors  
surgical-flat  
21 cm, hook  
63x12 mm



Langenbeck Retractors  
surgical-flat  
21 cm, hook  
**AG4-1298** 30x16 mm  
**AG4-1299** 42x11 mm  
**AG4-1300** 63x12 mm



Langenbeck Retractors  
21 cm, hook  
**AG4-1301** 30x11 mm  
**AG4-1302** 30x16 mm



**AG4-1303**  
Middelborpf  
Retractors  
21 cm

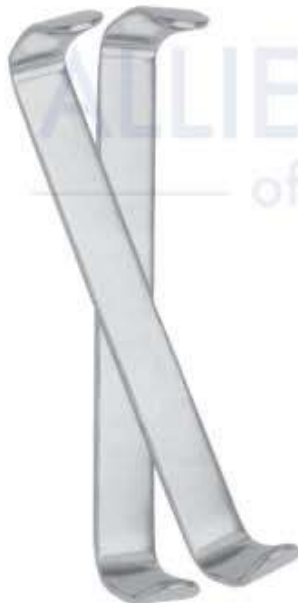

**AG4-1304**  
Farabeuf  
(120 X 12mm  
Set of 2 pices)



**AG4-1305**  
Retractor Seldin



**AG4-1306**  
Feldman Retractor  
14cm

## GUM SCISSORS

- Ножницы десневые
  - Ciseaux a gencives
  - Zahnfleischscheren
- Ножиці для ясен
  - Tijeras para encias
  - مقص صمغ



## GUM SCISSORS

- Ножницы десневые
- Ciseaux a gengives
- Zahnfleischscheren
- Ножиці для ясен
- Tijeras para encias
- ملص صمغ



**AG4-1335**  
Iris  
115mm  
Angled



**AG4-1336**  
Iris  
115mm  
Curved



**AG4-1337**  
Goldman-Fox  
130mm  
Saw edge,  
straight



**AG4-1338**  
Goldman-Fox  
130mm  
Saw edge,  
curved



**AG4-1339**  
Goldman-Fox  
130mm  
Saw edge,  
double curved



**AG4-1340**  
La Grange  
115mm  
Saw edge,  
double curved



**AG4-1341**  
Neumann  
120mm  
Saw edge,  
double curved



**AG4-1342**  
Kilner (Ragnell)  
120mm  
Straight



**AG4-1343**  
Kilner (Ragnell)  
120mm  
Curved



**AG4-1344**  
Joseph  
140mm  
Straight



**AG4-1345**  
Joseph  
140mm  
Curved



**AG4-1346**  
Kelly  
160mm  
Straight



**AG4-1347**  
Kelly  
160mm  
Curved



**AG4-1348**  
Locklin  
160mm  
Saw edge,  
angular



**AG4-1349**  
Locklin  
120mm  
Saw edge,  
angular



**AG4-1351**  
Dean  
170mm  
Saw edge,  
angular



**AG4-1352**  
Spencer  
90mm



**AG4-1353**  
Spencer  
130mm



**AG4-1354**  
Spencer  
115mm



**AG4-1355**  
Noyes  
110mm, Straight



**AG4-1356**  
Noyes  
110mm  
Curved



**AG4-1357**  
Noyes  
110mm  
Angular



**AG4-1358**  
Castroviejo  
150mm  
Curved

## GUM SCISSORS

- Ножницы десневые
- Ciseaux a gengivas
- Zahnfleischscheren

- Ножиці для ясен
- Tijeras para encias
- منصص صمغ

## NEEDLE HOLDERS

- Иглодержатели
- Porte-aiguilles
- Nadelhalter

- Голкотримачі
- Porta-agujas
- اصحاب ابرة



**AG4-1359**  
130mm  
Straight



Mayo  
**AG4-1360** 130mm  
**AG4-1361** 160mm  
**AG4-1362** 180mm  
Straight Curved



Mayo  
**AG4-1363** 140mm  
**AG4-1364** 200mm  
Straight Curved



Metzenbaum  
**AG4-1365** 145mm  
**AG4-1366** 200mm  
Straight Curved



**AG4-1367**  
Beebee  
110mm  
Saw edge,  
straight



**AG4-1368**  
Beebee  
110mm  
Saw edge,  
curved



**AG4-1369**  
Beebe  
110mm  
Saw edge, straight



**AG4-1370**  
Beebe  
110mm  
Saw edge, curved

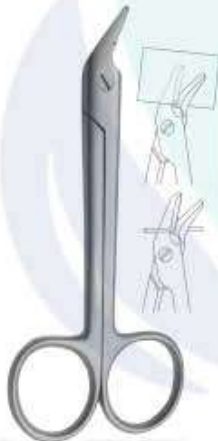

**AG4-1371**  
Universal  
120mm  
Saw edge



**AG4-1372**  
Universal  
120mm



Ryder  
**AG4-1373** 130mm  
**AG4-1374** 150mm  
**AG4-1375** 180mm



**AG4-1376**  
Halsey  
130mm



**AG4-1377**  
Baumgartner  
130mm



**AG4-1378**  
Derf  
120mm



**AG4-1379**  
Delicate  
150mm



Mayo-Hegar  
**AG4-1380** 130mm  
**AG4-1381** 160mm  
**AG4-1382** 180mm  
**AG4-1383** 200mm



**AG4-1384**  
Crile-Wood  
150mm  
straight



**AG4-1385**  
Crile-Wood  
150mm  
curved

## NEEDLE HOLDERS

- Иглодержатели
  - Porte-aiguilles
  - Nadelhalter
- Голкотримачи
  - Porta-agujas
  - اصحاب ابرة



Ryder  
AG4-1386 130mm  
AG4-1387 150mm  
AG4-1388 180mm



AG4-1389  
Halsey  
130mm



AG4-1390  
Baumgartner  
130mm



AG4-1391  
Derf  
120mm



AG4-1392  
Delicate  
150mm



AG4-1393  
Adson  
170mm



Mayo-Hegar  
AG4-1394 130mm  
AG4-1395 160mm  
AG4-1396 180mm  
AG4-1397 200mm



AG4-1398  
Crile-Wood  
150mm



Castroviejo  
AG4-1399 str 140mm cvd  
AG4-1400 str 180mm cvd



Olsen-Hegar Needle  
Holder With Scissors  
AG4-1401 140mm



Gillies Needle  
Holder With Scissors  
AG4-1402 160mm



Mathieu  
AG4-1403 140mm  
AG4-1404 170mm



Castroviejo  
AG4-1405 str 140mm cvd  
AG4-1406 str 180mm cvd



Olsen-Hegar Needle  
Holder With Scissors  
AG4-1407 140mm



Gillies Needle  
Holder With Scissors  
AG4-1408 160mm

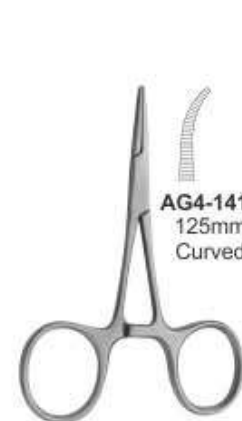

Hartmann (Baby  
Mosquito)  
AG4-1409 90mm straight

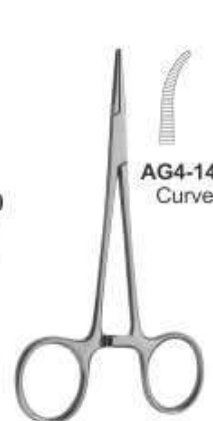

Halstead Mosquito  
AG4-1411 125mm  
Straight  
AG4-1412  
Curved

## GUM SCISSORS

- Ножницы десневые
- Ciseaux a gencives
- Zahnfleischscheren
- Ножиці для ясен
- Tijeras para encias
- مقص صمغ



**AG4-1413**  
Goldman Fox Scissors  
12.5cm Curved



**AG4-1414**  
Iris Scissors  
11.5cm Curved  
Serrated For Slip-Free Cutting



**AG4-1415**  
LaGrange Scissors  
11.5cm Double Curved  
Serrated For Slip-Free Cutting

Double  
Curved



**AG4-1416**  
Castroviejo Micro Scissors  
12cm Curved



**AG4-1417**  
Super Cut Goldman Fox  
13.2cm Curved  
Serrated For Slip-Free Cutting



**AG4-1418**  
Super Cut Iris  
11cm Straight  
Serrated For Slip-Free Cutting



**AG4-1419**  
Super Cut LaGrange  
11cm Curved  
Serrated For Slip-Free Cutting



**AG4-1420**  
Super Cut LaGrange  
11.5cm  
Double Curved  
Serrated For Slip-Free Cutting

Double  
Curved

## NEEDLE HOLDERS

- Иглодержатели
- Porte-aiguilles
- Nadelhalter

- Голкотримачи
- Porta-agujas
- اصحاب ابرة



**AG4-1421**  
Lichtenberg-  
Ryder T.C  
14 cm



**AG4-1422**  
Lichtenberg-  
Ryder T.C  
14 cm



**AG4-1423**  
Lichtenberg-  
Ryder T.C  
17 cm



**AG4-1424**  
Lichtenberg-  
Ryder T.C  
17 cm



**AG4-1425**  
Barraquer  
18 cm



**AG4-1426**  
Barraquer  
18 cm



**AG4-1427**  
Barraquer T.C  
18 cm



**AG4-1428**  
Barraquer T.C  
18 cm

**AG4-1429**  
Tönnis  
18 cm



**AG4-1430**  
Castroviejo  
13 cm  
Straight



**AG4-1431**  
Kalt Needle Holders T.C  
14 cm Straight



**AG4-1433**  
La Grange  
Curved

**AG4-1432**  
Peet Splinter Forceps  
11.5 cm



**AG4-1434**  
All-Purpose Pliers



## HAEMOSTATIC FORCEPS & TOWEL CLAMPS

- Зажимы артериальные, зажимы для салфеток
- Pincas hemostatiques, Pincas a compresas
- Arterienklemmen, Tuyschklemmen
- Затискачі артеріальні, затискачі для серветок
- Pinzas hemostaticas, Pincas para compresas
- الملقط هيموستاتيک المشابک مندلغة

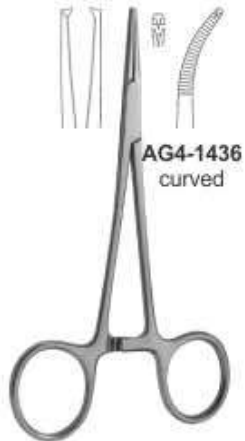

**AG4-1436**  
curved  
**Halstead Mosquito 1x2**  
**AG4-1435** 125mm  
straight

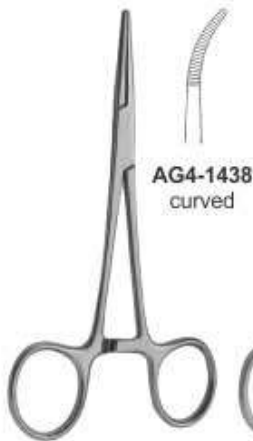

**AG4-1438**  
curved  
**Kelly**  
**AG4-1437** 140mm  
straight

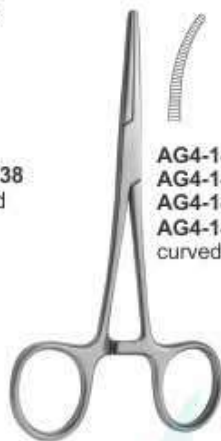

**AG4-1443** 140mm  
**AG4-1444** 160mm  
**AG4-1445** 180mm  
**AG4-1446** 200mm  
curved  
**Rochester-Pean**  
**AG4-1439** 140mm  
**AG4-1440** 160mm  
**AG4-1441** 180mm  
**AG4-1442** 200mm  
straight

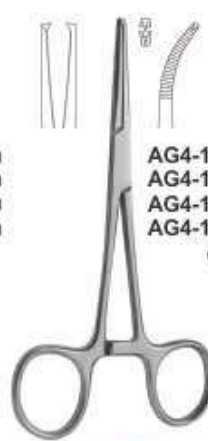

**AG4-1451** 140mm  
**AG4-1452** 160mm  
**AG4-1453** 180mm  
**AG4-1454** 200mm  
curved  
**Rochester-Kocher 1x2**  
**AG4-1447** 140mm  
**AG4-1448** 160mm  
**AG4-1449** 180mm  
**AG4-1450** 200mm  
straight

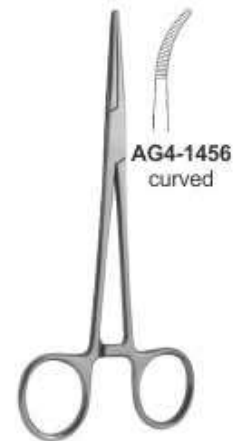

**AG4-1455**  
curved  
**Kelly-Rankin**  
160mm  
straight

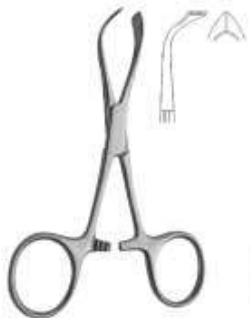

**Lorna**  
**AG4-1457** 100mm  
**AG4-1458** 130mm



**AG4-1459**  
**Allis-Baby 3:4**  
150mm



**AG4-1460**  
**Allis 4:5**  
200mm



**AG4-1461**  
**Allis 6:7**  
200mm



**Ball Socket**  
**AG4-1462** 140mm  
Not-perforating and  
not-damaging



**AG4-1463**  
**Backhaus**  
130mm



**AG4-1464**  
**Backhaus**  
85mm



**AG4-1465**  
**Jones**  
90mm



**AG4-1139**  
curved  
**Gross Maier**  
**Dressing Forceps**  
**AG4-1466** 200mm straight



**Foerster**  
**Dressing Forceps**  
**AG4-1467** 200mm



**Young**  
**Tongue Forceps**  
**AG4-1468** 170mm



**Collins**  
**Tongue Forceps**  
**AG4-1469** 170mm

## RUBBER DAM CLAMPS FORCEPS

- Инструменты для системы коффердам
- Pincas porte-crampons a dique
- Kofferdam Klammerzangen
- Инструменти для системи коффердам
- Pinzas de engrapar para dique de caucho
- السد المطاط المناطق المشابهة



### AG4-1470

On request the Content of the rubber dam kit can be changed with other instruments.

#### Content:

- 01 Anisworth
- 02 Brewer
- 03 Clamps Stand
- 04 Denture Plate
- 05 Rubber Dam Frame
- 06 Rubber Dam Box Lower Case
- 07 Rubber Dam Box Upper Case
- 08 Rubber Dam Clamp Fig. 212
- 09 Rubber Dam Clamp Fig. 211
- 10 Rubber Dam Clamp Fig. 8
- 11 Rubber Dam Clamp Fig. 8A
- 12 Rubber Dam Clamp Fig. 14
- 13 Rubber Dam Clamp Fig. 14A
- 14 Rubber Dam Clamp Fig. 0
- 15 Rubber Dam Clamp Fig. 00
- 16 Rubber Dam Clamp Fig. 2
- 17 Rubber Dam Clamp Fig. 2A
- 18 Rubber Dam Clamp Fig. 7



**AG4-1474**  
Brewer



**AG4-1475**  
Stockes



**AG4-1476**  
Palmer



**AG4-1477**  
Ivory light weight



**AG4-1478**  
Anisworth



**AG4-1479**  
Anisworth



**AG4-1480**  
Anisworth



**AG4-1481**  
Ivory



**AG4-1482**  
Separating  
Elastic Plier

## RUBBER DAM CLAMPS KITS

- Резиновая дамба зажимы комплекты
- Trousses de caoutchouc
- Gummidammklammern

- Гумова дамба затискачі комплекти
- Conjuntos de abrazaderas de retención de caucho
- المطاط السد المشابك مجموعات



**AG4-1483**

Stainless Steel Gold Plated Rubber Dam Clamp Tray with 11 Different Clamps  
Fig. 212, 211, 8, 8A, 14, 14A, 0, 00, 2, 2A, 7



**AG4-1484**

Stainless Steel Rubber Dam Clamp Tray with 12 Different Clamps  
Fig. 209, 212, 211, 8, 8A, 14, 14A, 0, 00, 2, 2A, 7



**AG4-1485**

Stainless Steel Rubber Dam Clamp Tray with 8 Different Clamps  
Fig. 1, 26, 29, 51, 60, 202, 205, 210



**AG4-1486**

Stainless Steel Rubber Dam Clamp Tray  
(without clamps)



**AG4-1487**

On request the Content of the rubber dam kit can be changed with other instruments.

**Content:**

- 01 Ivory
- 02 Ivory light weight
- 03 Clamps Stand
- 04 Rubber Dam Frame M
- 05 Rubber Dam Frame L
- 06 Rubber Dam Box Lower Case
- 07 Rubber Dam Box Upper Case

- 08 Rubber Dam Clamp Fig. 209
- 09 Rubber Dam Clamp Fig. 212
- 10 Rubber Dam Clamp Fig. 211
- 11 Rubber Dam Clamp Fig. 8
- 12 Rubber Dam Clamp Fig. 8A
- 13 Rubber Dam Clamp Fig. 14
- 14 Rubber Dam Clamp Fig. 14A
- 15 Rubber Dam Clamp Fig. 0
- 16 Rubber Dam Clamp Fig. 00
- 17 Rubber Dam Clamp Fig. 2
- 18 Rubber Dam Clamp Fig. 2A
- 19 Rubber Dam Clamp Fig. 7

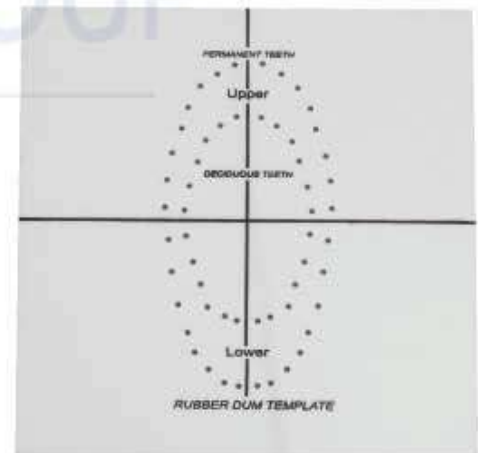

**AG4-1488**  
Rubber Dum Template

## RUBBER DAM CLAMPS

- Кляммера для коффердама
  - Crampons pour digue
  - Kofferdam Klammern
- Кляммера для коффердама
  - Grapas para dique de caucho
  - المشابك السد المطاط



**AG4-1489**  
Fig. 15



**AG4-1490**  
Fig. 18



**AG4-1491**  
Fig. 24



**AG4-1492**  
Fig. 25



**AG4-1493**  
Fig. 26



**AG4-1494**  
Fig. 28



**AG4-1495**  
Fig. 30



**AG4-1496**  
Fig. 31



**AG4-1497**  
Fig. 51



**AG4-1498**  
Fig. 138



**AG4-1499**  
Fig. 139



**AG4-1500**  
Fig. 200



**AG4-1501**  
Fig. 201



**AG4-1502**  
Fig. 202



**AG4-1503**  
Fig. 203



**AG4-1504**  
Fig. 204



**AG4-1505**  
Fig. 205



**AG4-1506**  
Fig. 3



**AG4-1507**  
Fig. W3



**AG4-1508**  
Fig. 4



**AG4-1509**  
Fig. 56A



**AG4-1510**  
Fig. 7



**AG4-1511**  
Fig. 7A



**AG4-1512**  
Fig. 8



**AG4-1513**  
Fig. 8A



**AG4-1514**  
Fig. W8A



**AG4-1515**  
Fig. 10



**AG4-1516**  
Fig. 11



**AG4-1517**  
Fig. 12A



**AG4-1518**  
Fig. 13A



**AG4-1519**  
Fig. 14



**AG4-1520**  
Fig. 14A



**AG4-1521**  
Fig. 14AN



**AG4-1522**  
Fig. 22



**AG4-1523**  
Fig. 27



**AG4-1524**  
Fig. 207



**AG4-1525**  
Fig. 29



**AG4-1526**  
Fig. 206



**AG4-1527**  
Fig. 208



**AG4-1528**  
Fig. 209



**AG4-1529**  
Fig. 1



**AG4-1530**  
Fig. 1A



**AG4-1531**  
Fig. 2



**AG4-1532**  
Fig. 2A



**AG4-1533**  
Fig. W2A



**AG4-1534**  
Fig. 0



**AG4-1535**  
Fig. 00



**AG4-1536**  
Fig. 210



**AG4-1537**  
Fig. 211



**AG4-1538**  
Fig. 212



**AG4-1539**  
Fig. 6



**AG4-1540**  
Fig. 9



**AG4-1541**  
Fig. N06



**AG4-1542**  
Fig. U67



**AG4-1543**  
Fig. 214



**AG4-1544**  
Fig. P1



**AG4-1545**  
Fig. P2



**AG4-1546**  
Fig. G-1



**AG4-1547**  
Fig. G-2

# CROWN REMOVER

- Инструменты для удаления коронок
  - Arrache-couronnes
  - Teleskopkronenzangen
- Инструменты для видалення коронок
  - Arranca-corona
  - مزيلات التاج



**AG4-1548**  
Crown Spreaders



**AG4-1550**  
Universal  
Fig. 0



Manual Crown Removers  
Handle with 3 tips **AG4-1551**  
Only 3 tips **AG4-1552 to AG4-1554**



Manual Crown Removers  
Handle with 3 tips **AG4-1555**  
Only 3 tips **AG4-1556 to AG4-1558**



**AG4-1559**  
Manual Crown  
Remover



**AG4-1560**  
Manual Crown Remover



**AG4-1561**  
Complete with 3 tips  
and tightening keys

semi-automatic crown  
& bridge remover



**AG4-1562**

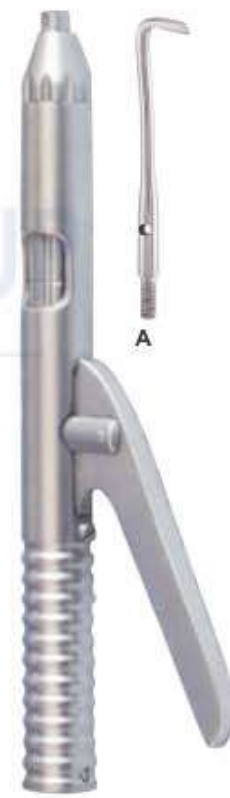

**AG4-1563**  
Manual Crown Remover

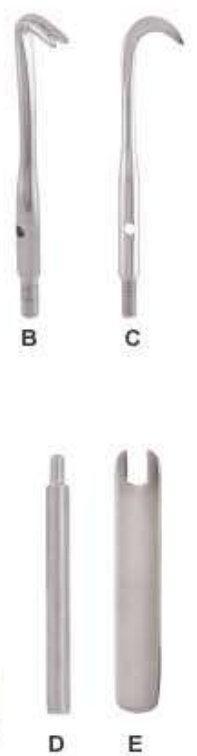

## MATRIX RETAINERS

- Матрицедержатели
  - Porte Matrices
  - Matrizenspanner
- Матрицеутримувачи
  - Porta Matrices
  - مصفوفة الختم



**AG4-1564**  
Fig. 5  
Ivory 8  
5 cm



**AG4-1565**  
Fig. 6  
Ivory 8  
6 cm



**AG4-1566**  
Fig. 7  
Ivory 8  
7 cm



**AG4-1567**  
Fig. 1  
Tofflemire-Universal



**AG4-1568**



**AG4-1569**



**AG4-1570**

### Siqveland Retainers



**AG4-1571**  
Fig. 2  
Tofflemire-Junior



**AG4-1572**  
Fig. 3  
Tofflemire-Senior



**AG4-1573**  
Narrow



**AG4-1574**  
Wide

### Amalgam Well



**AG4-1575**  
Stainless Steel  
Amalgam Well



**AG4-1576**  
Ivory 12



**AG4-1577**  
Ivory 1



**AG4-1578**  
Ivory



**AG4-1579**  
Elliot

## AMALGAM INSTRUMENTS

- Инструменты для амальгамы
- Instruments pour amalgame
- Amalgamis/Instrumente
- Инструменти для амальгами
- Instrumentos para amalgama
- الصكوك الملقم



**AG4-1580**  
Fig. 10  
165mm  
English pattern



**AG4-1581**  
Fig. 1  
185mm  
German pattern



**AG4-1582**  
Fig. 1  
150mm  
Swiss pattern



**AG4-1583**  
Fig. 1  
150mm



**AG4-1584**  
Fig. 2  
150mm, 45°



**AG4-1585**  
Fig. 3  
140mm, 90°



**AG4-1586**  
Chip Blower



**AG4-1587**



**AG4-1588**



**AG4-1589**



**AG4-1590**  
Water Syringe

## AMALGAM INSTRUMENTS

- Инструменты для амальгамы
- Instruments pour amalgame
- Amalgamis/instrumente
- Инструменты для амальгами
- Instrumentos para amalgama
- الصكوك المنغم

### AMALGAM CARRIERS

#### TIP SIZES FOR DISTAL OR SINGLE-END

1.5 mm



**AG4-1592**  
Mini/  
Single-End

2.0 mm



**AG4-1593**  
Regular  
Single-End

2.8 mm



**AG4-1594**  
Large  
Single-End

1.5 mm



**AG4-1595**  
Mini  
Distal

2.0 mm



**AG4-1596**  
Regular  
Distal

#### TIP SIZES FOR DOUBLE-END

1.5 mm



2.0 mm  
**AG4-1597**  
Mini/  
Regular

2.8 mm



2.0 mm  
**AG4-1598**  
Large/  
Regular

3.2 mm



2.0 mm  
**AG4-1599**  
Jumbo/  
Regular



**AG4-1600**  
Amalgam  
Well



**AG4-1591**  
Single-End

#### TIP SIZES FOR DOUBLE-END

**AG4-1601** - 1.5mm-2.0mm    **AG4-1604** - 1.0mm-2mm  
**AG4-1602** - 2.0mm-2.8mm    **AG4-1605** - 2.0mm-3mm  
**AG4-1603** - 2.0mm-3.2mm    **AG4-1606** - 2.0mm-4mm

**AG4-1607** - 1.5mm-2.0mm    **AG4-1610** - 1.0mm-2mm  
**AG4-1608** - 2.0mm-2.8mm    **AG4-1611** - 2.0mm-3mm  
**AG4-1609** - 2.0mm-3.2mm    **AG4-1612** - 2.0mm-4mm

**AG4-1613** - 1.5mm-2.0mm    **AG4-1616** - 1.0mm-2mm  
**AG4-1614** - 2.0mm-2.8mm    **AG4-1617** - 2.0mm-3mm  
**AG4-1615** - 2.0mm-3.2mm    **AG4-1618** - 2.0mm-4mm

**AG4-1619** - 1.5mm-2.0mm    **AG4-1622** - 1.0mm-2mm  
**AG4-1620** - 2.0mm-2.8mm    **AG4-1623** - 2.0mm-3mm  
**AG4-1621** - 2.0mm-3.2mm    **AG4-1624** - 2.0mm-4mm

**AG4-1625** - 1.5mm  
**AG4-1626** - 2.0mm  
**AG4-1627** - 2.0mm  
**AG4-1628** - 3.0mm





# CHISELES, BONE FILES & SPOONE CURETTE



## ROOT PLANNING FILES & BONE FILES

### ROOT PLANNING FILES



**AG4-1641**  
Kramer-Nevins  
Bone Chisel



**AG4-1642**  
Kramer-Nevins  
Bone Chisel



**AG4-1643**  
Molt 18.5cm  
Auto Clavable  
Plastic Tips.

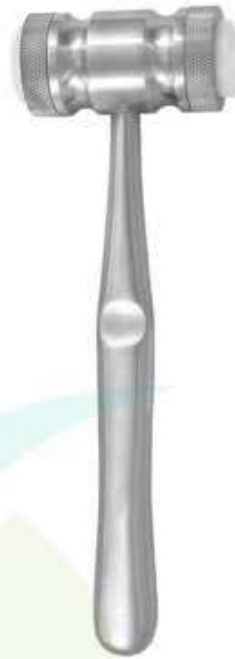

**AG4-1644**  
Mead 18.5cm  
Non Auto Clavable  
Plastic Tips.



**AG4-1645**  
Miller



**AG4-1646**  
Miller

### BONE FILES



**AG4-1647**  
Miller 21



**AG4-1648**  
Miller 1X  
cross cut



**AG4-1649**  
Miller 2X  
cross cut



**AG4-1650**  
Miller 52



**AG4-1651**  
Wahl 1

# PERIODONTAL INSTRUMENTS

- Инструменты пародонтологические
  - Instruments pour la parodontologie
  - Instrumente für die Parodontologie
- Інструменти пародонтологічні
  - Instrumentos para periodoncia
  - الصكوك اللثة

## PERIOSTEEL ELEVATORS



**AG4-1652**  
Ohi 10



**AG4-1653**  
Howard 9H



**AG4-1654**  
Freer



**AG4-1655**  
Freer 15



**AG4-1656**  
Freer 16



**AG4-1657**



**AG4-1658**  
Raspator, Raspatory  
Length 175 mm



**AG4-1659**



**AG4-1660**



**AG4-1661**

**Raspator, Williger**  
Length 170 mm, different widths  
(4 mm, 5 mm or 7 mm)



**AG4-1662**



**Partsch 140 mm**  
**AG4-1663** 3mm  
**AG4-1664** 4mm  
**AG4-1665** 5mm  
**AG4-1666** 6mm



**Partsch 170 mm**  
**AG4-1667** 3mm  
**AG4-1668** 4mm  
**AG4-1669** 5mm  
**AG4-1670** 6mm



**Partsch 140 mm**  
**AG4-1671** 3mm  
**AG4-1672** 4mm  
**AG4-1673** 5mm  
**AG4-1674** 6mm



**Partsch 170 mm**  
**AG4-1675** 3mm  
**AG4-1676** 4mm  
**AG4-1677** 5mm  
**AG4-1678** 6mm

## PERIODONTAL INSTRUMENTS

- Инструменты пародонтологические
- Instruments pour la parodontologie
- Instrumente für die Parodontologie
- Инструменти пародонтологічні
- Instrumentos para periodoncia
- الصكوك اللثة

To separate tissue tooth or bone. tp hold tissue away from surgical site.

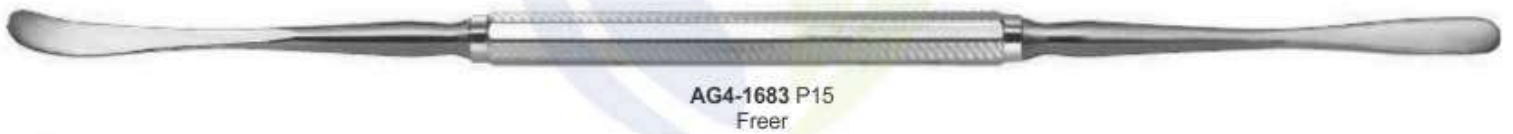
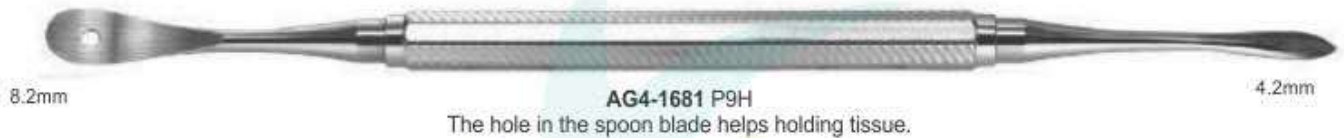

## PERIODONTAL INSTRUMENTS

- Инструменты пародонтологические
- Instruments pour la parodontologie
- Instrumente für die Parodontologie
- Інструменти пародонтологічні
- Instrumentos para periodoncia
- الصكوك اللثة



**AG4-1689**



**AG4-1690**  
P24G



**AG4-1691**  
titanium Periosteal Elevator for Implan5



**AG4-1692**  
S1



**AG4-1693**  
Hirschfeld



**AG4-1694**  
9S



10mm

**AG4-1695**  
Selden

13mm



4.8 mm

**AG4-1696**  
Friedmann

10.6 mm



**AG4-1697**  
Schmidlin

6.9 mm

## SCALPEL HANDLES

- Ручки для скальпелей
- Manches de bistouris
- Skalpellgriffe
- Ручки для скальпелів
- Mangos de bisturi
- مشرط مقابض



**AG4-1698**  
Fig.3  
12.7cm



**AG4-1699**  
Fig.3G  
12.7cm



**AG4-1700**  
Fig.4  
13.7cm



**AG4-1701**  
Double Handle  
No.4 + No.3  
16.3cm



**AG4-1702**  
Fig. 7  
16.5cm



**AG4-1703**  
Scalpel Handle Straight  
for blades #10-15  
14.5cm



**AG4-1704**  
Micro Surgical Scalpel  
Handle titanium  
13.5cm



**AG4-1705**  
Fig. 5  
14.5cm



**AG4-1706**  
Fig. 5A  
14.5cm



**AG4-1707**  
6 Way Adjustable Angled  
Scalpel Handle

## MALLETS - PLASTER SHEARS - SAWS & BLADES



**AG4-1708**  
Metal tip  
220 mm  
Hammer With Wooden Handle



**AG4-1709**  
Metal tip  
220 mm



**AG4-1710**  
1  
For plaster



**AG4-1711**  
2  
For metal



**AG4-1712**  
Fret saw  
250 mm



**AG4-1713**  
Small  
Saw Blades



**AG4-1714**  
Large  
Saw Blades



**AG4-1715**  
Ceri Saw



Special Inox  
**AG4-1716** 170mm  
**AG4-1717** 200mm



**AG4-1718**  
Plaster Shears  
200 mm



Crucible Tongs  
**AG4-1719** 250 mm  
**AG4-1720** 320 mm



**AG4-1721**  
Ceri Saw  
180 mm



**AG4-1722**  
Blade  
0,12x5 mm  
Conf. 12 pcs



**AG4-1723**  
Blade  
0,25x5 mm  
Conf. 12 pcs



**AG4-1724**  
Blade  
0,25x3 mm  
Conf. 12 pcs



Behind Every Smile is a Story

- QUALITY - ЯКІСТЬ
- PRECISION - ТОЧНІСТЬ
- ACCURACY - ПРАВИЛЬНІСТЬ
- DURABILITY - ЗНОСОСТІЙКІСТЬ





# ORTHODONTIC INSTRUMENTS

- Инструменты ортодонтические
- Instrumentos Ortodonticos
- Orthodontische Instrumente
- Инструменти ортодонтични
- Instruments Orthodontiques
- أدوات تقويم الأسنان



**AG5-1800**  
Height Gauge 0.18  
Aluminum



**AG5-1801**  
Height Gauge 0.22  
Aluminum



**AG5-1802**  
Height Gauge 0.18  
Stainless Steel



**AG5-1803**  
Height Gauge 0.22  
Stainless Steel



**AG5-1804**  
Moveable  
Height Gauge



**AG5-1805**  
Endo Finger  
Ruler Span  
Measure Scale



**AG5-1806**  
Endo Finger  
Ruler Span  
Measure Scale



**AG5-1807**  
Endo Finger  
Ruler Span  
Measure Scale



**AG5-1808**  
Positive  
Postioner



**AG5-1809**  
Strip Saw



**AG5-1810**  
Bone Bracket Gauge



**AG5-1811**  
Endo Finger Ruler  
Span Measure Scale



**AG5-1812**  
Endo Finger Ruler  
Span Measure Scale

## ORTHODONTIC INSTRUMENTS

- Инструменты ортодонтические
- Instrumentos Ortodonticos
- Orthodontische Instrumente
- Инструменти ортодонтични
- Instruments Orthodontiques
- ادوات تقويم الأسنان



**AG5-1813**  
Measuring Loop  
angled, length  
175 mm,  
measuring range  
0 - 40 mm



**AG5-1814**  
Measuring Loop  
straight length  
175 mm,  
measuring range  
0 - 40 mm



**AG5-1815**  
Measuring loop, Castroviejo  
angled, length 175 mm,  
measuring range 0 - 40 mm,  
with window



**AG5-1816**  
Measuring Loop  
straight length 90 mm,  
measuring range  
0 - 40 mm,  
**AG5-1817**  
Castroviejo Calipers  
20mm  
90mm



**AG5-1818**  
Measuring Loop  
angled, length 90 mm,  
measuring range  
0 - 40 mm,  
**AG5-1819**  
Castroviejo Calipers  
20mm, 45°  
90mm



**AG5-1820**  
Castroviejo Calipers  
20mm  
90mm



**AG5-1821**  
Fig. 1  
Iwanson  
spring caliper  
For metal and  
porcelain.



**AG5-1822**  
Fig. 2  
Iwanson  
spring caliper  
For wax.

## ORTHODONTIC INSTRUMENTS

- Инструменты ортодонтические
- Instrumentos Ortodonticos
- Orthodontische Instrumente
- Инструменти ортодонтични
- Instruments Orthodontiques
- ابوات تقويم الأسنان



**AG5-1823**  
Boley Gauge



**AG5-1824**  
Vernier Gauge



**AG5-1825**  
Aluminium Caliper  
up to 200mm



**AG5-1826**  
Boley Gauge



**AG5-1827**  
Delux Boley  
Gauge



**AG5-1828**  
Beerendonk  
130mm  
Mini Gauge



**AG5-1829**  
Compasso  
De Willis



**AG5-1830**  
Dentaurum  
Ruler



**AG5-1831**  
Ruler Wedge



**AG5-1832**  
Ruler

## ORTHODONTIC INSTRUMENTS

- Инструменты ортодонтические
- Instrumentos Ortodonticos
- Orthodontische Instrumente
- Инструменти ортодонтични
- Instruments Orthodontiques
- ادوات تقويم الأسنان

### Bracket Holder Tweezers



**AG5-1833**  
Deluxe Bracket  
Holder Tweezers



**AG5-1834**  
Deluxe Bracket  
Holder Tweezers



**AG5-1835**  
Direct Bond Bracket  
Holder Tweezers



**AG5-1836**  
Bracket Tweezers  
Slot Aligner



**AG5-1837**  
Direct Bond  
Bracket Holder  
Tweezers, Small Tip



**AG5-1838**  
Exact Bracket  
Holder Tweezers



**AG5-1839**  
Bracket Placing  
Tweezers



**AG5-1840**  
Easy Access  
Tweezers



**AG5-1841**  
Bracket Placer  
Tweezers  
(Extra Fine Tip)



**AG5-1842**  
Deluxe Bracket  
Holder Tweezers  
135mm



**AG5-1843**  
Easy Eccess  
Tweezers



**AG5-1844**  
Slipper  
Tweezers



**AG5-1845**  
Direct Bonding  
Bracket Holders  
135mm



**AG5-1846**  
Direct Bonding  
Bracket Holders  
136mm



**AG5-1847**  
Direct Bonding  
Bracket Holders  
135mm



**AG5-1848**  
Deluxe Bracket  
Holder



**AG5-1849**  
Direct Bonding  
Bracket Holders  
140mm

## ORTHODONTIC INSTRUMENTS

- Инструменты ортодонтические
- Instrumentos Ortodonticos
- Orthodontische Instrumente
- Инструменти ортодонтични
- Instruments Orthodontiques
- ابوات تقويم الأسنان



**AG5-1850**  
Band seater  
auto cleavable



**AG5-1851**  
Band seater  
auto cleavable  
Triangle Shape



**AG5-1852**  
Band seater  
auto cleavable  
Square Shape



**AG5-1853**  
Band seater  
auto cleavable  
Round Shape



**AG5-1854**  
Mershon Band  
Pusher  
140mm



**AG5-1855**  
Band seating &  
removing  
instruments



**AG5-1856**  
Ortho Light double  
ended  
ligature director  
scaler



**AG5-1857**  
Ortho Light Band  
Pusher Scaler



**AG5-1858**  
Band Seating &  
Removing  
Silicon Grip



**AG5-1859**  
Ligature Instrument  
Silicon Grip



**AG5-1860**  
Elastic Instrument  
Silicon Grip



**AG5-1861**  
Distal Bender  
Silicon Grip



**AG5-1862**  
Distal Bender  
Silicon Grip



**AG5-1863**  
Distal Bender  
Silicon Grip

## ORTHODONTIC INSTRUMENTS

- Инструменты ортодонтические
- Instrumentos Ortodonticos
- Orthodontische Instrumente
- Инструменти ортодонтични
- Instruments Orthodontiques
- ادوات تقويم الأسنان



**AG5-1864**  
Ortho light scaler double ended



**AG5-1865**  
Ortho light scaler double ended



**AG5-1866**  
Ortho light scaler double ended



**AG5-1867**  
Twiel-on elastic module instrument



**AG5-1868**  
Twiel-on elastic module instrument



**AG5-1869**  
Schure Band Seater



**AG5-1870**  
Ortho light scaler



**AG5-1871**  
Ortho light scaler



**AG5-1872**  
Ortho light scaler heavy



**AG5-1873**  
Ortho instrument



**AG5-1874**  
Ortho instrument

## ORTHODONTIC INSTRUMENTS

- Инструменты ортодонтические
- Instrumentos Ortodonticos
- Orthodontische Instrumente
- Инструменти ортодонтични
- Instruments Orthodontiques
- ابوات تقويم الأسنان



**AG5-1875**  
Ortho Light double ended  
ligature director



**AG5-1876**  
Ortho Light double ended ligature scaler director tivate coil spring  
are remove modules with one instruments



**AG5-1877**  
Ortho band pusher scaler



**AG5-1878**  
Ortho ligature director single ended



**AG5-1879**  
Ortho Light double ended ligature  
director scaler



**AG5-1880**  
Ortho Light double ended ligature scaler/director  
tivate coil spring are remove modules with one instruments



**AG5-1881**  
Ortho Light double ended ligature director



**AG5-1882**  
Ortholite Ligature Director Scaler



**AG5-1883**  
Ortho light ligature director double ended



**AG5-1884**  
Double ended cement spatula



**AG5-1885**  
Ortho light scaler single ended

## PLIERS FOR ORTHODONTICS & PROSTHETICS

- Щипцы для ортодонтии и протезирования
- Pincers pour l'orthodontie et la prothèse
- Zangen für Kieferorthopädie und Prothetik
- Щипці для ортодонції та протезування
- Alicates para ortodoncia y prótesis
- كمشة لتقويم الأسنان برومبئیس

### BOX JOINT PLIERS

**AG5-1886**  
Universal Dolphin Style  
Wire Bending & cutting pliers



**AG5-1892**  
Bracket Removing Plier curved  
Bracket Removing Plier curved for  
easy removal of brackets in the  
posterior region. Length 130mm



**AG5-1887 Band Removing Plier**  
The curved blade of the band  
removing plier can strip easily  
and gently remove directly to  
the tooth. Length 130mm



**AG5-1893**  
Young Wire Bending &  
Loop Forming Pliers



**AG5-1888**  
Tweed Loop  
forming Pliers



**AG5-1894**  
Wire Bending &  
Loop Forming Pliers



**AG5-1889**  
How Plier curved  
Universally usable tool for  
the multiband technology for  
wires up to .028".  
Length 130mm



**AG5-1895**  
Adams, small wire bending  
and loop forming Pliers



**AG5-1890 How Plier**  
Universally usable tool for the  
multiband technology for wires  
up to .028".  
Length 135mm



**AG5-1896**  
Bracket Removing Plier Round Box  
Bracket removing plier for comfortable  
and quick removal of the brackets.  
Length 135mm



**AG5-1891**  
Nance Loop  
forming Pliers



**AG5-1897**  
Weingart Plier medium  
Weingart plier that are ideal due to  
their curved plier tip for setting sheets and  
is capable of bending the ends.  
Length 145mm





## PLIERS FOR ORTHODONTICS & PROSTHETICS

- Щипцы для ортодонтии и протезирования
- Щипці для ортодонції та протезування
- Pincers pour l'orthodontie et la prothèse
- Alicates para ortodondia y prótesis
- Zangen für Kieferorthopädie und Prothetik
- كمشة لتقويم الأسنان بروتستیس

### BOX JOINT PLIERS

**AG5-1898 Adams Plier Round Box**  
Adams pliers for bending wire arches and bends right angles for wires up to .022", .025 tip to beak. Length 125mm



**AG5-1899 Falcon Beak Contouring Pliers.**



**AG5-1900**  
wires up to 0.020" / 0.7mm.



**AG5-1901 Johnson Contouring Pliers**



**AG5-1902 Aderer**  
Large wire bending and loop forming pliers



**AG5-1903 Tweed / angle rectangular arch forming & Torquing pliers**



**AG5-1904 Adams Plier**  
Adams pliers for bending wire arches and bends right angles for wires up to .022", .025 tip to beak. Length 125mm

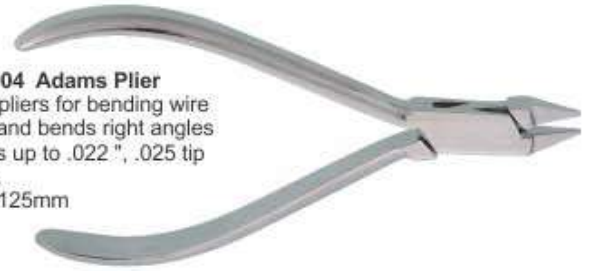

**AG5-1905 Tweed Loop Formin Pliers**



**AG5-1906 Bird Beak Plier Standard**  
Bird Beak Wire bending plier without notches, which is suitable as a universal utility tool. Length 125mm



**AG5-1907 Mini Ligature cutters**



**AG5-1908 Small Fluch-cut distal and cutting Pliers**  
with safety hold fitted with un-breakable, corrosion resistant and durable stainless steel tips



**AG5-1909 Large Fluch-cut distal and cutting Pliers**  
with safety hold fitted with un-breakable, corrosion resistant and durable stainless steel tips



## PLIERS FOR ORTHODONTICS & PROSTHETICS

- Щипцы для ортодонтии и протезирования
- Pincers pour l'orthodontie et la prothèse
- Zangen für Kieferorthopädie und Prothetik
- Щипці для ортодонції та протезування
- Alicates para ortodoncia y prótesis
- كمشة لتقويم الأسنان برومینیس

### BOX JOINT PLIERS

**AG5-1910**

**Tweed / Angel**

1.78mm (.070") wide tips arch forming and torquing pliers



**AG5-1916**

**Contouring Plier**



**AG5-1911**

**Tweed / Angel**

1.78mm (.070") wide tips arch forming and torquing pliers



**AG5-1917**

**Bands & Crowns Plier**  
in order to skirt



**AG5-1912**

**Lingual / Palatal arch forming pliers**



**AG5-1918**

**Ligature Forming Pliers**



**AG5-1913**

**Aderer**

Facebow loop forming Pliers



**AG5-1919**

for double back and triple back bands in 0.30" / 0.76mm & 0.36" / 0.91mm lingual arch wires



**AG5-1914**

Waldsavhs wire bending and cutting pliers



**AG5-1920**

**Bird Beak Wire Bending & cutting pliers**



**AG5-1915 Aderer Plier**

For the manufacturing of appliances and activation of wires for wires up to .030" .fine tip and up to .036" mean tip. Length 130mm



**AG5-1921**

**Weingart Plier medium**

Weingart plier that are ideal due to their curved tip for setting sheets and is capable of bending the ends. Length 145mm



## PLIERS FOR ORTHODONTICS & PROSTHETICS

- Щипцы для ортодонтии и протезирования
- Щипці для ортодонтії та протезування
- Pincas pour l'orthodontie et la prothèse
- Alicates para ortodoncia y prótesis
- Zangen für Kieferorthopädie und Prothetik
- كاشطة لتقويم الأسنان بروسیتیس

### L-KEY JOINT PLIERS



#### AG5-1922

Distal end cutter with safety hold, mini head, long handles. fitted with un-breakable, corrosion resistant and durable stainless steel tips

- 0.30 mm to 0.50 mm (.012" to .020")
- Max. 0.46 mm x 0.64 mm (.018" x .025")
- ⊗ 0.38 mm to 0.53 mm (.0155" to .0215")
- ⊠ Max. 0.53 mm x 0.64 mm (.021" x .025")



#### AG5-1923

Flush-cut distal end cutter with safety hold fitted with un-breakable, corrosion resistant and durable stainless steel tips

- 0.30 mm to 0.50 mm (.012" to .020")
- Max. 0.46 mm x 0.64 mm (.018" to .025")



#### AG5-1924

Soft wire and ligature cutter, Mini fitted with un-breakable, corrosion resistant and durable stainless steel tips

- ⌋ .25 mm to .38 mm (.010" to .015")



#### AG5-1925

Soft wire and ligature cutter, standard fitted with un-breakable, corrosion resistant and durable stainless steel tips

- ⌋ .25 mm to .38 mm (.010" to .015")



#### AG5-1926

Soft wire and ligature cutter, 15° angled fitted with un-breakable, corrosion resistant and durable stainless steel tips

- ⌋ .25 mm to .38 mm (.010" to .015")



#### AG5-1927

Soft wire and ligature cutter, 45° angled fitted with un-breakable, corrosion resistant and durable stainless steel tips

- ⌋ .25 mm to .38 mm (.010" to .015")



#### AG5-1928

Hard wire cutter, straight Fitted with un-breakable, corrosion resistant and durable stainless steel tips

- 0.30 mm to 0.50 mm (.012" to .020")
- Max. 0.56 mm x 0.71 mm (.022" x .028")



#### AG5-1929

Hard wire cutter, 15° angled Fitted with un-breakable, corrosion resistant and durable stainless steel tips

- 0.30 mm to 0.50 mm (.012" to .020")
- Max. 0.56 mm x 0.71 mm (.022" x .028")



#### AG5-1930

















Hard wire cutter, 15° angled Non-autoclavable

- 0.30 mm to 0.50 mm (.012" to .020")
- Max. 0.56 mm x 0.71 mm (.022" x .028")

## PLIERS FOR ORTHODONTICS & PROSTHETICS

- Щипцы для ортодонтии и протезирования
- Pincers pour l'orthodontie et la prothèse
- Zangen für Kieferorthopädie und Prothetik
- Щипці для ортодонції та протезування
- Alicates para ortodoncia y prótesis
- كمشة لتقويم الأسنان برومینیس

### L-KEY JOINT PLIERS

|   |   |  |   |
|---|---|--|---|
|    |  <p><b>AG5-1931</b><br/>Band removing pliers</p>                       |    |  <p><b>AG5-1936</b><br/>Weingart-mini<br/>Utility Pliers</p> <ul style="list-style-type: none"> <li>● 0.30 mm to 0.50 mm (.012" to .020")</li> <li>■ Max 0.56 mm x 0.71 mm (.022" x .028")</li> </ul>                              |
|    |  <p><b>AG5-1932</b><br/>Bracket removing pliers angled</p>             |    | <p><b>AG5-1937</b><br/>Weingart<br/>Utility Pliers</p> <ul style="list-style-type: none"> <li>● 0.30 mm to 0.50 mm (.012" to .020")</li> <li>■ Max 0.56 mm x 0.71 mm (.022" x .028")</li> </ul>   |
|  |  <p><b>AG5-1933</b><br/>Bracket removing pliers straight</p>         |  |  <p><b>AG5-1938</b><br/>How Straight<br/>Utility Pliers</p> <ul style="list-style-type: none"> <li>● 0.30 mm to 0.50 mm (.012" to .020")</li> <li>■ Max 0.56 mm x 0.71 mm (.022" x .028")</li> </ul>                              |
|  |  <p><b>AG5-1934</b><br/>Bracket removing pliers with plastic tip</p> |  | <p><b>AG5-1939</b><br/>Angled<br/>Utility Pliers</p> <ul style="list-style-type: none"> <li>● 0.30 mm to 0.50 mm (.012" to .020")</li> <li>■ Max 0.56 mm x 0.71 mm (.022" x .028")</li> </ul>   |
|  |  <p><b>AG5-1935</b><br/>Adhesive removing pliers</p>                 |  |  <p><b>AG5-1940</b><br/>Wire bending and loop forming pliers<br/>Angled (Bird beak)</p> <ul style="list-style-type: none"> <li>● 0.30 mm to 0.50 mm (.012" to .020")</li> <li>■ Max 0.56 mm x 0.71 mm (.022" x .028")</li> </ul> |

## PLIERS FOR ORTHODONTICS & PROSTHETICS

- Щипцы для ортодонтии и протезирования
- Pincers pour l'orthodontie et la prothèse
- Zangen für Kieferorthopädie und Prothetik
- Щипці для ортодонції та протезування
- Alicates para ortodoncia y prótesis
- كمشة لتقويم الأسنان بروتستیس

### L-KEY JOINT PLIERS



**AG5-1941**  
Multi-purpose pliers, bird beak,  
De la rosa and cutter in one

- 0.30 mm to 0.50 mm (.012" to .020")
- Max. 0.46 mm x 0.56 mm (.018" x .022")



**AG5-1946**  
Stop pliers V-Bebd - 1mm

- 0.30 mm to 0.50 mm (.012" to .020")
- Max. 0.43 mm x 0.56 mm (.017" x .028")



**AG5-1942**  
Cinch Back / tie back  
Distal end bending pliers

- 0.30 mm to 0.50 mm (.012" to .020")
- Max. 0.56 mm x 0.71 mm (.022" x .028")



**AG5-1947**  
Lingual / palatal arch forming plies

- 0.76 mm (.030") / 0.91 mm (.036")



**AG5-1943**  
Hammer head  
Distal end bending pliers

- 0.30 mm to 0.50 mm (.012" to .020")
- Max. 0.56 mm x 0.71 mm (.022" x .028")



**AG5-1948**  
Torquing pliers set



**AG5-1944**  
Nance  
Loop forming pliers

- 0.36 mm to 0.71 mm (.014" to .028")
- Max. 0.56 mm x 0.71 mm (.022" x .028")



**AG5-1949**  
Tweed / angel  
Rectangular arch forming and  
torquing pliers

- 0.30 mm to 0.71 mm (.012" to .028")
- Max. 0.56 mm x 0.71 mm (.022" x .028")



**AG5-1945**  
Detailing step pliers / Bayonet  
bending pliers - 1mm

- 0.30 mm to 0.50 mm (.012" to .020")
- Max. 0.56 mm x 0.71 mm (.022" x .028")



**AG5-1950**  
Surgical ball hook crimping pliers,  
angled



**AG5-1951**  
Surgical ball hook crimping  
pliers, straight



## PLIERS FOR ORTHODONTICS & PROSTHETICS

- Щипцы для ортодонтии и протезирования
- Pincers pour l'orthodontie et la prothèse
- Zangen für Kieferorthopädie und Prothetik
- Щипці для ортодонції та протезування
- Alicates para ortodoncia y prótesis
- كمشة لتقويم الأسنان برومینیس

### L-KEY JOINT PLIERS



**AG5-1952**  
Aderer Clamp three jaw wire bending plier for contouring and bending wire up to .30"/.76mm.



**AG5-1958**  
Falcon beak contouring plier.

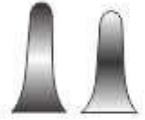

**AG5-1953**  
Bird beak plier for bending round, square and rectangle wire up to .30"/.76mm.

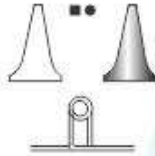

**AG5-1959**  
For placement and removal of arch wires, pins and other auxiliaries.



**AG5-1954**  
Bird beak plier for light wire bending round, square and rectangular up to .016"/0.41mm.

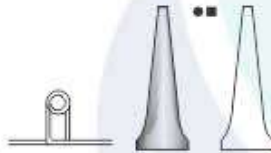

**AG5-1960**  
For placement and removal of arch wires, pins and other auxiliaries in angle design



**AG5-1955**  
Double Rounded jaw bending pliers, hooks and wire up to .020"/0.51mm.

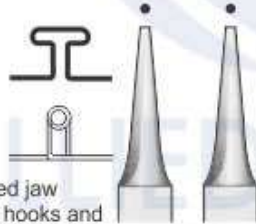

**AG5-1961**  
contouring Plier.



**AG5-1962**  
Bending plier. In order to skirt molares bands. With grooved. Recommended wire. 016", 018" and 022" 0.41mm, 0.46mm and 0.56mm



**AG5-1956**  
Adams pliers for hooks and bending wire up to .030"/0.76mm.

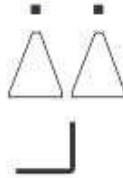

**AG5-1963**  
Loop forming in four length 3,4,5 & 6 mm wire capacity 0.22", 56mm.



**AG5-1957**  
Johnson pliers for crown band contouring



**AG5-1964**  
Arch bending plier design for convenient handling of square or rectangular wire, .020" / 0.51mm.



## PLIERS FOR ORTHODONTICS & PROSTHETICS

- Щипцы для ортодонтии и протезирования
- Щипці для ортодонції та протезування
- Pincas pour l'orthodontie et la prothèse
- Alicates para ortodondia y prótesis
- Zangen für Kieferorthopädie und Prothetik
- كمشة لتقويم الأسنان بروسیتیس

### LAP & L-KEY JOINT PLIERS



**AG5-1965**  
In order to skirt bands and crowns.



**AG5-1966**  
Wires up to .020" / 0.7mm.

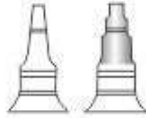

**AG5-1967**  
Round and concave plier for loop forming and banding wire up to .20" / .051mm.



**AG5-1968**  
Bending for round square or rectangular wire up to 0.30"/0.76mm



**AG5-1969**  
for double back and triple back bands in 0.30" / .76mm & 0.36" / .91mm lingual arch wires.



**AG5-1970**  
Detailing step plier double-sided offset beak permits bayonet bends. Creates right hand or left hand step-up or stepdown at 1/8, 3/8, or 1mm increments.

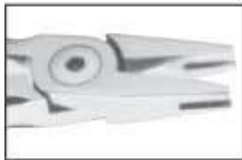

**AG5-1971**  
"V" bend stop special design makes 1mm "v" bends to shorten archwires or provide a positive stop. Excellent for placing stops in titanium wires. For round or rectangular wires up to .025"



**AG5-1972**  
Angle how plier efficient utility plier with serrated beaks for a firm grip. 45 angled tips to access hard to reach areas.



**AG5-1973**  
Weingardt plier serrated tips hold wires firmly at a convenient working angle. Tapered beaks fit easily between brackets and hard to reach areas. Our most popular utility plier.



**AG5-1974**  
Pin & Ligature Cutters TC.



**AG5-1975**  
Mini Pin & Ligature Cutter TC.



**AG5-1976**  
Standard Ligature Cutter TC.



**AG5-1977**  
V Bend Stop Plier TC.



**AG5-1978**  
Angled Direct Bond Bracket Remover TC.



**AG5-1979**  
Cutter Str.



Distal Cutter  
14cm  
**AG5-1980** 2.5 mm  
**AG5-1981** 3.0 mm  
**AG5-1982** 3.0 mm



**AG5-1983**  
Arrow Clasp Forming Pliers  
12.0cm



**AG5-1984**  
Schwarz  
12.5cm



## DISTAL END, WIRE CUTTERS & BRACKET REMOVER PLIERS

**AG5-1985**  
Distal end Cutter, Safety Hold Plier  
(Ideal for Cutting Wire) TC.



**AG5-1986**  
Hook Crimping Plier Angled  
Straight TC.



**AG5-1987**  
3 Prong Clasp Adjustable  
Plier TC.



**AG5-1988**  
Utility Plier Weingart TC.



**AG5-1989**  
Direct Bracket Remover  
TC.



**AG5-1990**  
Straight Direct Bond Bracket  
Remover TC.



**AG5-1991**  
Pin Holding Plier TC.



**AG5-1992**  
Hard wire cutters



**AG5-1993**  
Elastic Separating Plier  
Round Handle



**AG5-1994**  
Elastic  
Separating Plier



**AG5-1995 Str.**  
**AG5-1996 Cvd.**  
Smaha  
Elastomeric  
ligature  
placing forceps  
140 mm



**AG5-1997**  
Elastomeric  
ligature placing  
forceps with  
groove  
Falcon 140 mm



**AG5-1998**  
Elastomeric  
ligature placing  
forceps with  
groove  
Falcon 140 mm





## PLIERS FOR ORTHODONTICS & PROSTHETICS

- Щипцы для ортодонтии и протезирования
- Pincas pour l'orthodontie et la prothèse
- Zangen für Kieferorthopädie und Prothetik
- Щипці для ортодонції та протезування
- Alicates para ortodoncia y prótesis
- كمامة لتقويم الأسنان بروسثیتیس

### CUTTER, UTILITY PLIERS & WIRE FORMING PLIERS



**AG5-1999**  
Weingart Pliers



**AG5-2004**  
Adhesive  
Removing Pliers



**AG5-2000**  
Slim Weingart  
Pliers



**AG5-2005**  
Posterior Band Removing  
Pliers - Long



**AG5-2001**  
How Pliers  
Straight



**AG5-2006**  
Posterior Band Removing  
Pliers - Short



**AG5-2002**  
How Pliers Offset



**AG5-2007**  
Bird Beak Pliers



**AG5-2003**  
Band seating Pliers

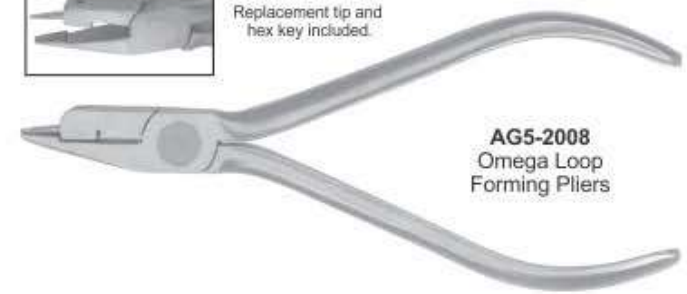

Replacement tip and  
hex key included.

**AG5-2008**  
Omega Loop  
Forming Pliers

## PLIERS FOR ORTHODONTICS & PROSTHETICS

- Щипцы для ортодонтии и протезирования
- Pincers pour l'orthodontie et la prothèse
- Zangen für Kieferorthopädie und Prothetik
- Щипці для ортодонції та протезування
- Alicates para ortodoncia y prótesis
- كمشة لتقويم الأسنان بروستیس

### CUTTERS



**AG5-2009**  
Hard  
Wire Cutter 15



**AG5-2013**  
Mini Pin &  
Ligature Cutter



**AG5-2010**  
Distal End Cutter  
Flush Cut



**AG5-2014**  
Hard Wire Cutter  
Straight



**AG5-2011**  
Universal Cut & Hold  
Distal End Cutter



**AG5-2015**  
Micro-Mini Pin &  
Ligature Cutter



**AG5-2012**  
Pin & Ligature  
Cutter



**AG5-2016**  
Cutter

## PLIERS FOR ORTHODONTICS & PROSTHETICS

- Щипцы для ортодонтии и протезирования
- Pincas pour l'orthodontie et la prothèse
- Zangen für Kieferorthopädie und Prothetik
- Щипці для ортодонції та протезування
- Alicates para ortodancia y prótesis
- كماشة لتقويم الأسنان بروسیتیس



**AG5-2017**  
Three Jaw Pliers



**AG5-2021**  
Jarabak Pliers

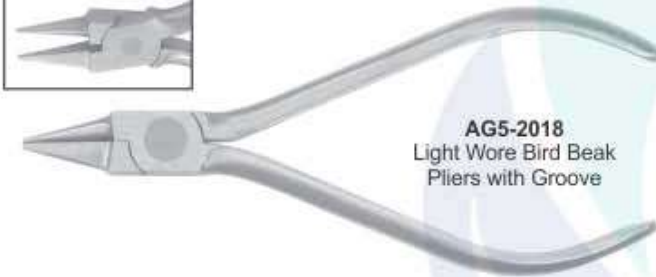

**AG5-2018**  
Light Wore Bird Beak  
Pliers with Groove



**AG5-2022**  
Hollow Chop  
Contouring Pliers



**AG5-2019**  
Tweed loop  
Forming Pliers



**AG5-2023**  
Lingual Arch  
Forming Pliers



**AG5-2020**  
Arch Bending Pliers



**AG5-2024**  
Rectangular Arch  
Bending Pliers

## ORTHODONTICS PLIERS STANDS

- Ортодонтия Щипцы Подставки
- Supports de pinces d'orthodontie
- Kieferorthopädie Zangenständer
- Ортодонтия Щипці Підставки
- KFO Zangen Ständer
- تقويم الأسنان كمشاة تقف



**AG5-2025**  
Plier Stand  
Stainless Steel.



**AG5-2026**  
Plier Stand  
Stainless Steel.



**AG5-2027**  
Pliers Stand  
Stainless Rod  
(Aluminum Anodized)  
Stainless Steel



**AG5-2028**  
Plier Stand  
Stainless Steel.



**AG5-2029**  
Plier Stand  
Stainless Steel.



**AG5-2030**  
Plier Stand  
Plastic

# Normal Anatomy – Dental Implants

Bone Level Normal  
(No Bone Loss)

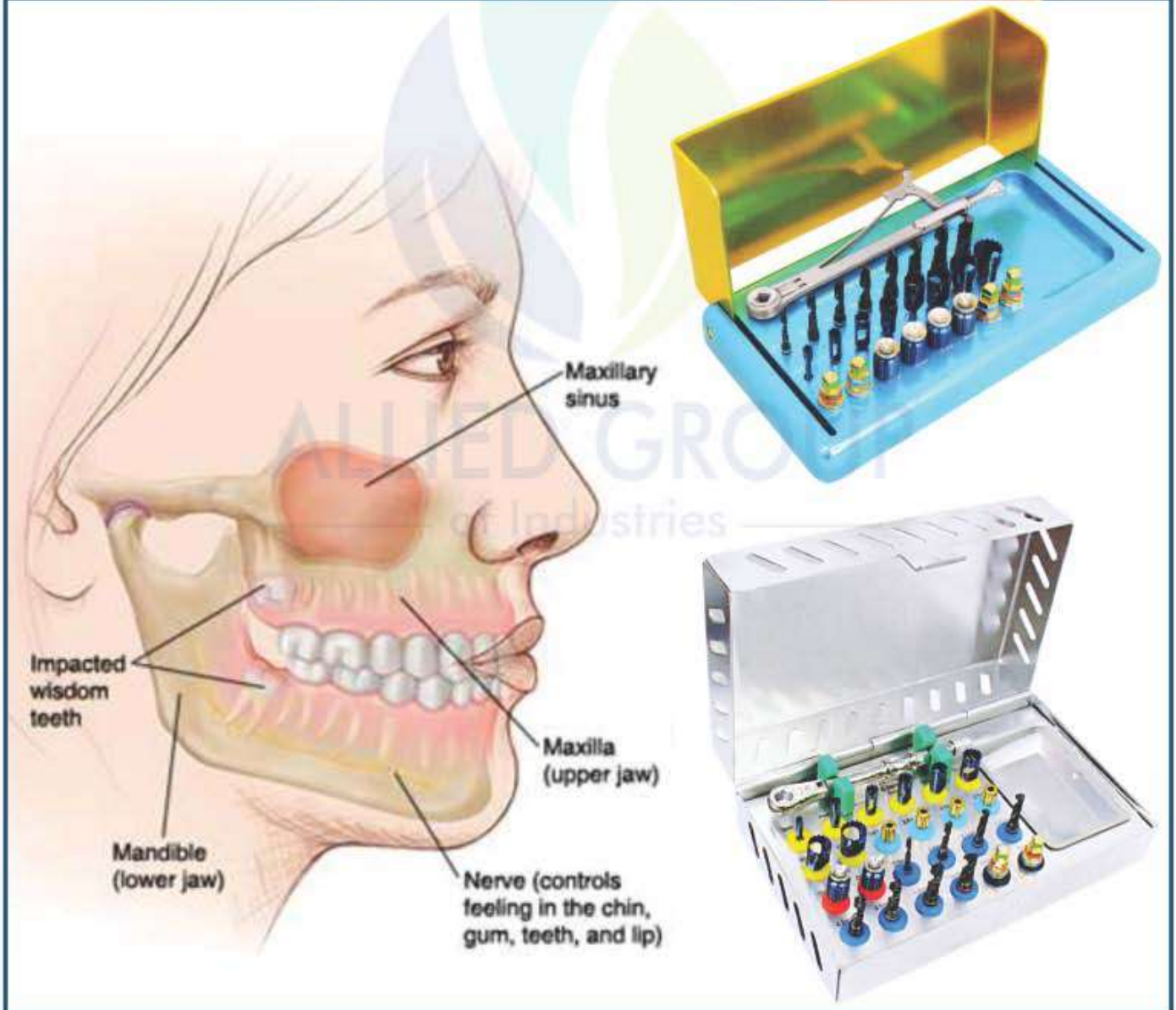
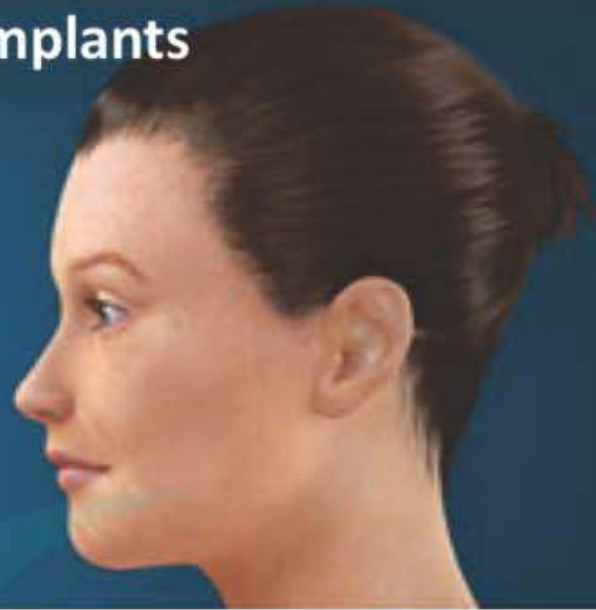
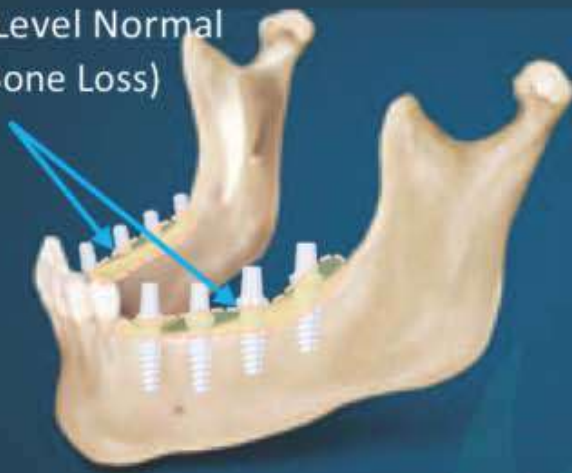

## IMPLANTOLOGY

- Инструменты для имплантологии
- Implantologie
- Implantologie
- Инструменти для імплантології
- Implantologia
- زراعة الأسنان

### IMPLANT GAGES



### IMPLANT GAGES



## IMPLANTOLOGY

- Инструменты для имплантологии
- Implantologie
- Implantologie

- Инструменти для имплантології
- Implantoloia
- زراعة الأسنان



**AG6-2110**  
Ridge Mapping  
Double Caliper



**AG6-2111**  
Bone Thickness Gauge  
40mm, 180mm



**AG6-2112**  
Osteometer  
Measuring Forceps For Jaw  
Ridge Width measurement, scale  
on both sides, rustfree, autoclaviv



**AG6-2113**  
Micro Boley  
Gauge Twisted



**AG6-2114**  
Micro Boley  
Gauge Straight



**AG6-2115**  
Ortho Ruler / Cone Socket

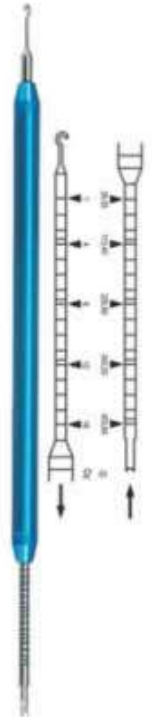

**AG6-2116**  
Dynamometer

## IMPLANTOLOGY

- Инструменты для имплантологии
- Implantologie
- Implantologie
- Инструменти для імплантології
- Implantologia
- زراعة الأسنان

### BLACK TITANIUM COLOUR COATED INSTRUMENTS





## IMPLANTOLOGY

- Инструменты для имплантологии
  - Implantologie
  - Implantologie
- Инструменти для имплантології
  - Implantoloia
  - زراعة الأسنان

### BLACK TITANIUM COLOUR COATED INSTRUMENTS



**AG6-2125**  
A  
Cosmetic  
Contouring

**AG6-2126**  
B  
Cosmetic  
Contouring

**AG6-2127**  
C  
Cosmetic  
Contouring

**AG6-2128**  
D  
Cosmetic  
Contouring

**AG6-2129**  
F  
Cosmetic  
Contouring

**AG6-2130**  
Marginal Ridge  
& Embrasure  
Shaping Instrument

**AG6-2131**  
Occlusal  
Anatomy  
Instrument

## IMPLANTOLOGY

- Инструменты для имплантологии
- Implantologie
- Implantologie
- Инструменти для імплантології
- Implantologia
- زراعة الأسنان

### BLACK TITANIUM COLOUR COATED INSTRUMENTS

#### BURNISHERS

#### FREEDMAN BURNISHERS



**AG6-2132**  
21B

**AG6-2133**  
27/29

**AG6-2134**  
2  
Ladmore

**AG6-2135**  
3  
Ladmore

**AG6-2136**  
Freedman  
"Duckhead"

**AG6-2137**  
Freedman  
Small Contact  
Forming

**AG6-2138**  
Freedman  
Large Contact  
Forming

**AG6-2139**  
Small/  
Medium Ball  
Burnisher

## IMPLANTOLOGY

- Инструменты для имплантологии
  - Implantologie
  - Implantologie
- Инструменти для імплантології
  - Implantoloia
  - زراعة الأسنان

### SINUS LIFT INSTRUMENTS HOLLOW HANDLE 9.5MM LENGTH 170MM

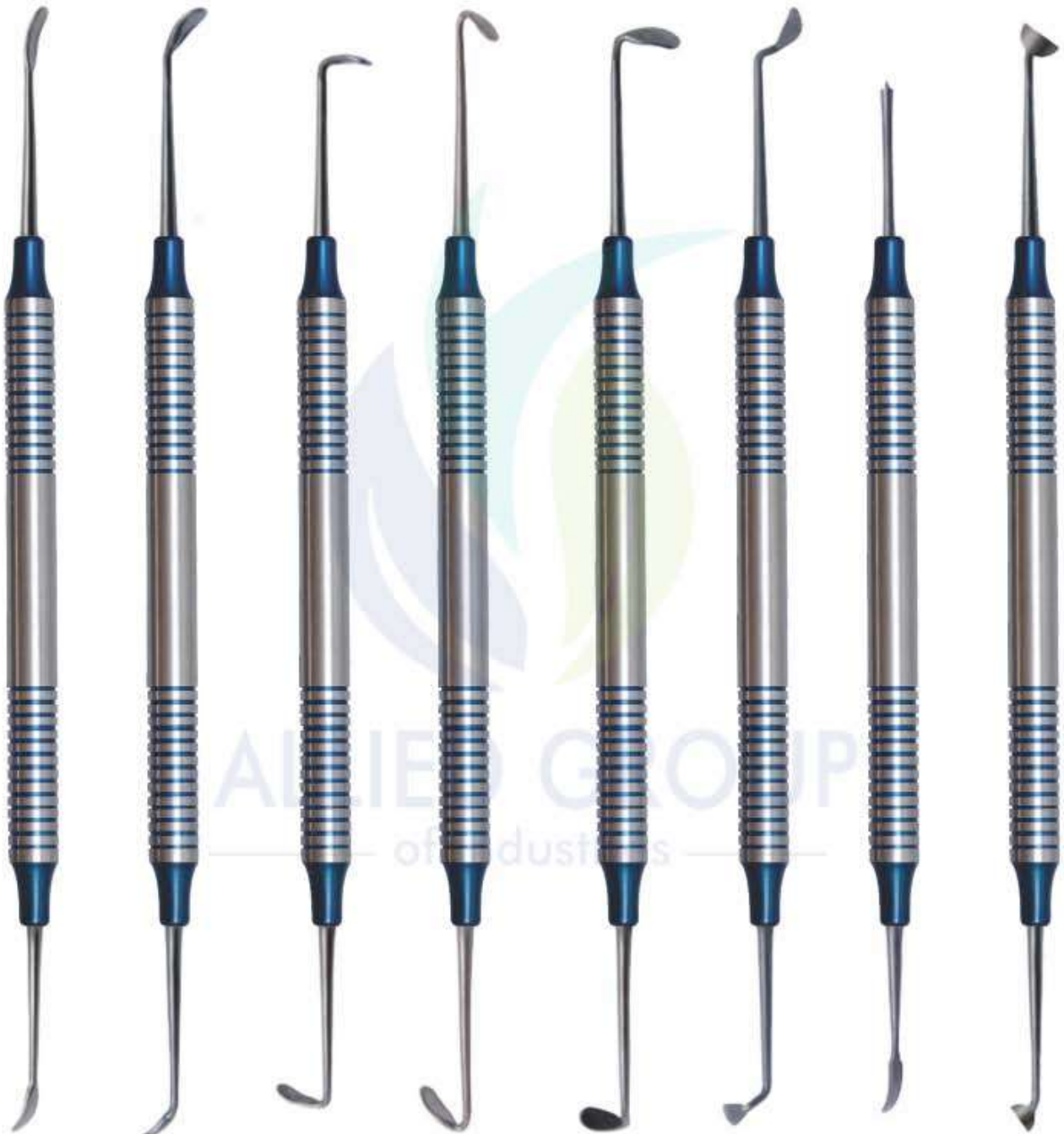

**AG6-2140**  
Sinuslift 1

**AG6-2141**  
Sinuslift 2

**AG6-2142**  
Sinuslift 3

**AG6-2143**  
Sinuslift 4

**AG6-2144**  
Sinuslift 5

**AG6-2145**  
Sinuslift 6

**AG6-2146**  
Membrane  
3Positioning 1

**AG6-2147**  
Condenser 1

## IMPLANTOLOGY

- Инструменты для имплантологии
  - Implantologie
  - Implantologie
- Инструменти для имплантології
  - Implantologia
  - زراعة الأسنان

**Sinus Lift Instrument,**  
Flexible Sinus Lift instruments  
reduce the risk of perforation of the  
"Schneider's membrane"



AG6-2148 AG6-2149  
Fig. 1 Fig. 2

AG6-2150  
Fig. 3

**Sinus Lift Elevator,**  
10 mm Straight grip  
Length 175 mm, Sinus lift elevators, dull,  
for gentle peeling and lifting the  
Schneider membrane



AG6-2151  
Fig. 1

AG6-2152  
Fig. 2

AG6-2153  
Fig. 3

**Sinus lift instrument**  
10 mm Straight grip Length 180 mm,  
Buser (B1, B2, B3) raspatories,  
quality medical stainless steel,  
corrosion-resistant



AG6-2154  
B01

AG6-2155  
B02

AG6-2156  
B03

## IMPLANTOLOGY

- Инструменты для имплантологии
  - Implantologie
  - Implantologie
- Инструменти для имплантології
  - Implantoloia
  - زراعة الأسنان

**Sinus lift instrument** 10 mm Straight grip Sinus lift elevators, blunt or sharply curved (H01, H02, K03, K04, K78, K77)

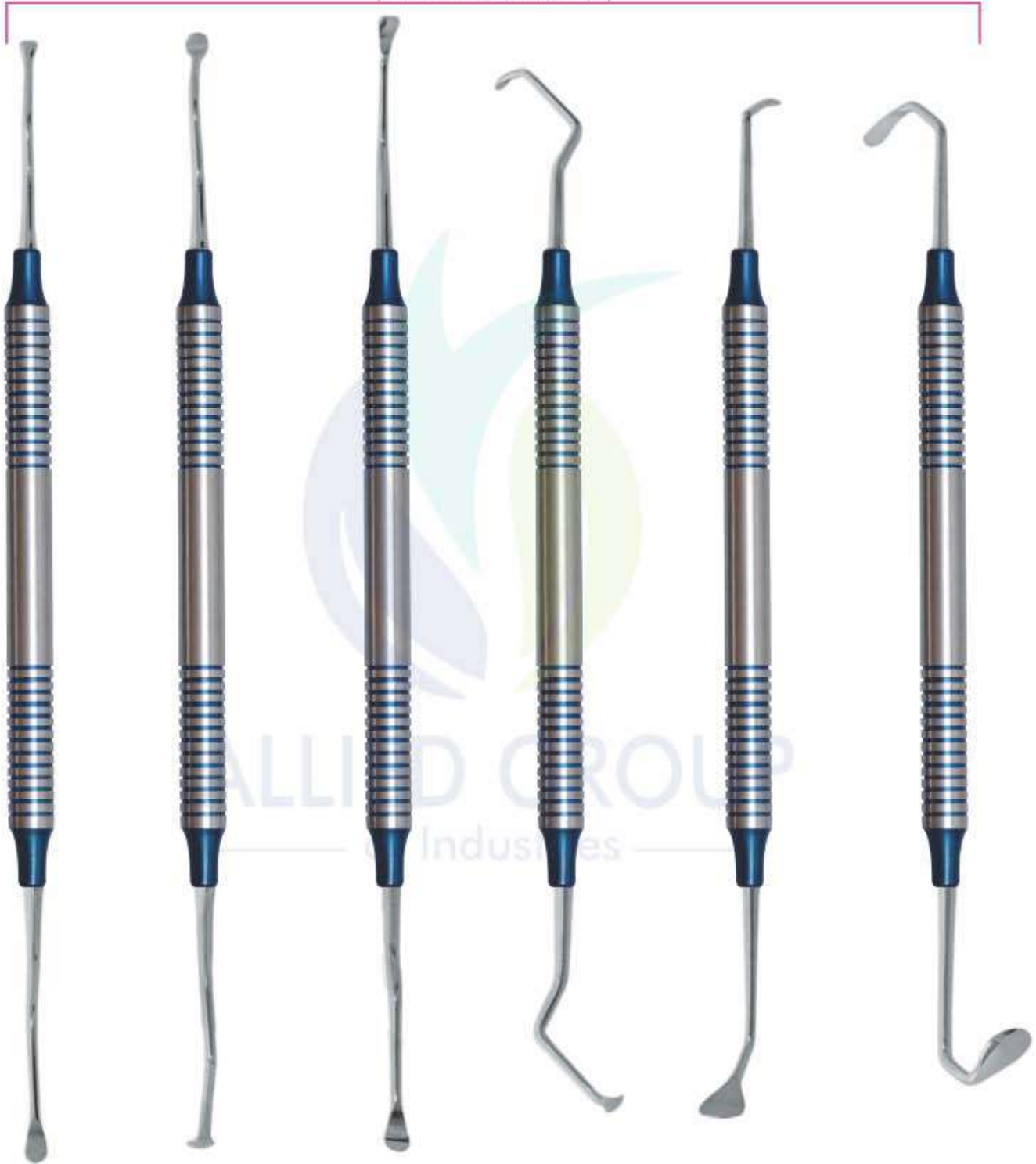

**AG6-2157**  
Sinus lift  
instrument  
H01

**AG6-2158**  
Sinus lift  
instrument  
H02

**AG6-2159**  
Sinus lift  
instrument  
K03

**AG6-2160**  
Sinus lift  
instrument  
K04

**AG6-2161**  
Sinus lift  
instrument  
K78

**AG6-2162**  
Sinus lift  
instrument  
K77

## IMPLANTOLOGY

- Инструменты для имплантологии
  - Implantologie
  - Implantologie
- Інструменти для імплантології
  - Implantoloia
  - زراعة الأسنان

### Composite Filling Instruments Set of 6 Pcs



AG6-2163



AG6-2164



AG6-2165



AG6-2166



AG6-2167



AG6-2168

#### COMPOSITE INSTRUMENTS USE:

A composite (tooth colored) filling is used to repair a tooth that is affected by decay, cracks, fractures, etc. The decayed or affected portion of the tooth will be removed and then filled with a composite filling.

There are many types of filling materials available, each with their own advantages and disadvantages. You and your dentist can discuss the best options for restoring your teeth. Composite fillings, along with silver amalgam fillings, are the most widely used today. Because composite fillings are tooth colored, they can be closely matched to the color of existing teeth, and are more aesthetically suited for use in front teeth or the more visible areas of the teeth.

As with most dental restorations, composite fillings are not permanent and may someday have to be replaced. They are very durable, and will last many years, giving you a long lasting, beautiful smile.

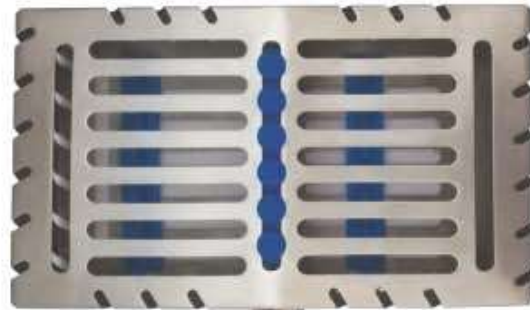

AG6-2169

## IMPLANTOLOGY

- Инструменты для имплантологии
- Implantologie
- Implantologie
- Инструменти для имплантології
- Implantoloia
- زراعة الأسنان

Set of 5 Composite Gold Tip Instruments  
**AG6-2170**



Set of 4 Composite Blue Tip Instruments  
**AG6-2171**

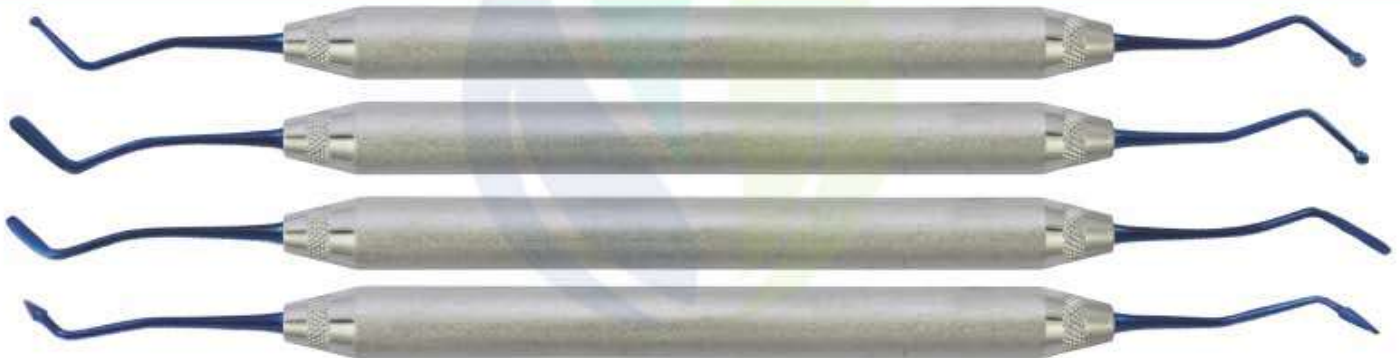

Set of 3 Composite Blue Tip Instruments  
**AG6-2172**



Set of 2 Composite Blue Tip Instruments  
**AG6-2173**



**AG6-2174** Periosteal Elevators Molt # 9

**AG6-2175** Endodontic explorer DG # 16

## IMPLANTOLOGY

- Инструменты для имплантологии
- Implantologie
- Implantologie
- Инструменти для імплантології
- Implantologia
- زراعة الأسنان

### VISTA TUNNELING INSTRUMENTS SET



AG6-2176



AG6-2177



AG6-2178



AG6-2179



AG6-2180



AG6-2181



AG6-2182





## IMPLANTOLOGY

- Инструменты для имплантологии
- Implantologie
- Implantologie

- Инструменти для имплантології
- Implantoloia
- زراعة الأسنان



**AG6-2183**  
used for elevation of sinus membrane



**AG6-2184**  
used for elevation of sinus membrane



**AG6-2185**  
Cobra in / out (2-4-5-6-8-10mm)



**AG6-2186**  
Cobra 3.5mm



**AG6-2187**  
sinus 4.8 / 5.8 (2-4-5-6-8-10mm)

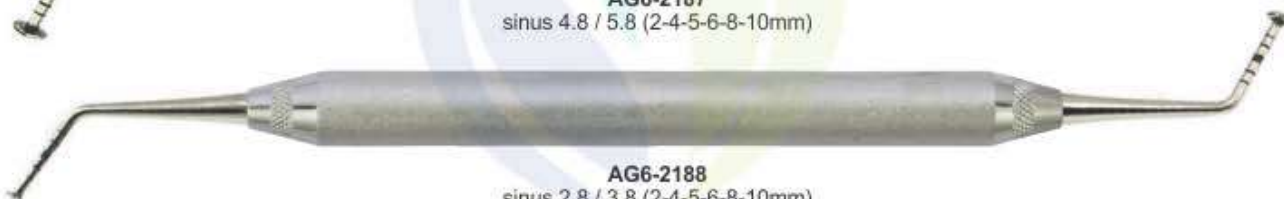

**AG6-2188**  
sinus 2.8 / 3.8 (2-4-5-6-8-10mm)



**AG6-2189**  
Bone Graft 3.8SP / 2.8mm (2-4-5-6-8-10mm)



**AG6-2190**  
Cobra in / out (2-4-5-6-8-10mm)



**AG6-2191**  
Cobra 3.5mm



**AG6-2192**  
Gold Color Set Dental Oral Implantology Sinus Set of 10 Pcs. with cassette

## IMPLANTOLOGY

- Инструменты для имплантологии
- Implantologie
- Implantologie
- Инструменти для імплантології
- Implantologia
- زراعة الأسنان



**AG6-2193**  
Sinus Lift elevator 1



**AG6-2194**  
Sinus Lift elevator 2



**AG6-2195**  
Sinus Lift elevator 3



**AG6-2196**  
Sinus Lift elevator 4



**AG6-2197**  
Sinus Lift elevator 5



**AG6-2198**  
Sinus Lift elevator 6



**AG6-2199**  
Sinus Lift Elevators Set of 7 Pcs  
with cassette

# IMPLANTOLOGY

- Инструменты для имплантологии
  - Implantologie
  - Implantologia
- Инструменти для имплантології
  - Implantoloia
  - زراعة الأسنان

## Sinus Left Elevator Set of 10 Pcs



## IMPLANTOLOGY

- Инструменты для имплантологии
  - Implantologie
  - Implantologie
- Інструменти для імплантології
  - Implantologia
  - زراعة الأسنان

### Blue Titanium Coated Bone Grafting Instruments



**AG6-2210**

Bone Graft 1.0 / 1.7 mm Titanium 8. 11. 13. 15. 18 mm

**AG6-2211**

Bone Graft 1.0 / 2.0 mm Titanium 8. 11. 13. 15. 18 mm

**AG6-2212**

Bone Graft 2.4 / 2.7 mm Titanium 8. 11. 13. 15. 18 mm

**AG6-2213**

Bone Graft 3.3 / 4.0 mm Titanium 8. 11. 13. 15. 18 mm

**AG6-2214**

Bone Graft 3.3 / 4.0 mm Titanium Coated Tips

**AG6-2215**

Bone Graft / Carrier Titanium 8. 11. 13. 15. 18 mm

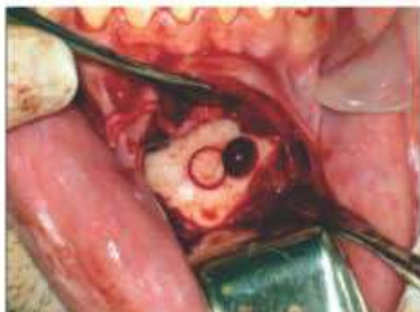

**AG6-2216**

Blue Titanium Coated Bone Grafting Instruments Set of 7 Pcs with cassette

# IMPLANTOLOGY

- Инструменты для имплантологии
- Implantologie
- Implantologie

- Инструменти для имплантології
- Implantoloia
- زراعة الأسنان



AG6-2217  
Fig. 1



With curette the sinus membrane is further detached over a broad area in the inner region, especially along the roof of the palate.



AG6-2218  
Fig. 2

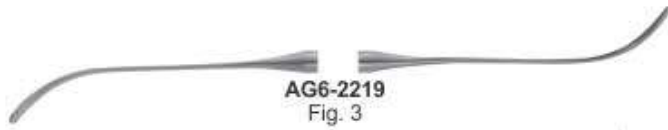

AG6-2219  
Fig. 3



AG6-2220  
Fig. 4



AG6-2221  
Fig. 5



AG6-2222  
Fig. 6



AG6-2223



AG6-2224



AG6-2225



AG6-2226

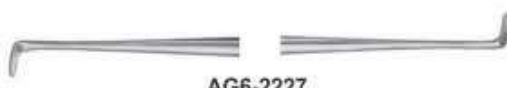

AG6-2227



### Flexible Sinus-Lift Currettes – for an optimum sensitivity during the direct lift procedure

The perforation of the Schneiderian membrane is a complication that often occurs during a maxillary sinus floor augmentation procedure. The Sinus-Lift Instruments increase the sensitivity by blunt and flexible working tips with "Swing-Effect". Because of their special shapes and the characteristic of the stainless steel between the handle and the active part, light pressure is cushioned and gives the operator a direct and sensitive response. At the same time the risk to perforate the Schneiderian membrane is reduced to a minimum. Already at the development the focus was a practicable handling. Because of varying angulations and shapes of the active parts also in difficult areas they are easy to navigate also in difficult areas. The line of currettes consists of six different figures for every situation. They are complemented by spoon and condenser to place the bone graft.

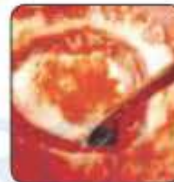

The "Schneider's Membrane" of the sinus can be detached with curette by 1–2mm along the total cortical bone.



Curette is particularly useful in the lower part for detaching the membrane further. The same goes for the caudal area, especially when the membrane is 4–5 mm above the base of the maxillary sinus and the maxillary sinus is built up with granular material.



Curette makes it possible to lift the membrane further in mesial region. One working tip is especially designed for the right maxillary sinus and the other for the left maxillary sinus.



With curette the sinus membrane is further elevated in the upper and posterior part of the maxillary sinus wall.

## IMPLANTOLOGY

- Инструменты для имплантологии
  - Implantologie
  - Implantologie
- Инструменти для імплантології
  - Implantologia
  - زراعة الأسنان

### IMPLANT SINUS LIFT INSTRUMENTS HOLLOW HANDLE 9.5MM LENGTH 170MM



**AG6-2228**  
Acute 6577

**AG6-2229**  
Sinus1

**AG6-2230**  
Sinus2

**AG6-2231**  
Sinus 3  
Obtuse 6578

**AG6-2232**  
Sinus 4

**AG6-2233**  
Sinus 5

**AG6-2234**  
Sinus 6

**AG6-2235**  
Sinus 7



9 Pcs of Set  
**AG6-2236**

### SINUS LIFT INSTRUMENTS HOLLOW HANDLE 9.5MM LENGTH 170MM



**AG6-2238**  
Sinuslift 2

**AG6-2239**  
Sinuslift 3

**AG6-2240**  
Sinuslift 4

**AG6-2241**  
Sinuslift 5

**AG6-2242**  
Sinuslift 6

**AG6-2243**  
Membrane  
3Positioning 1

**AG6-2244**  
Condenser 1

**AG6-2237**  
Sinuslift 1



9 Pcs of Set  
**AG6-2245**

# IMPLANTOLOGY

- Инструменты для имплантологии
- Implantologie
- Implantologie

- Инструменти для имплантології
- Implantologia
- زراعة الأسنان

IMPLANT SINUS LIFT INSTRUMENTS  
PERIODONTAL SURGERY SURGICAL CHISELS  
KRAMER NEVINS SINUS LIFT

**SURGICAL CHISELS**



AG6-2246  
TG



AG6-2247 SOLT3/4



AG6-2248 TGO

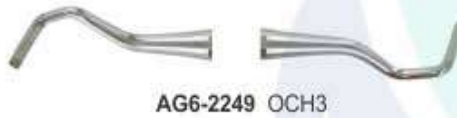

AG6-2249 OCH3

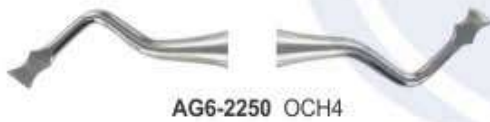

AG6-2250 OCH4



AG6-2251 FEDI1



AG6-2252 FEDI2



AG6-2253 FEDI3



AG6-2254 13K/TG



AG6-2255  
13K/TG Titanium



AG6-2256 13K/TG



AG6-2257  
13KL/R Titanium



AG6-2258 13KL 4/6mm  
Titanium Available



AG6-2259  
Cassette For Instruments

## IMPLANTOLOGY

- Инструменты для имплантологии
  - Implantologie
  - Implantologie
- Инструменти для імплантології
  - Implantologia
  - زراعة الأسنان

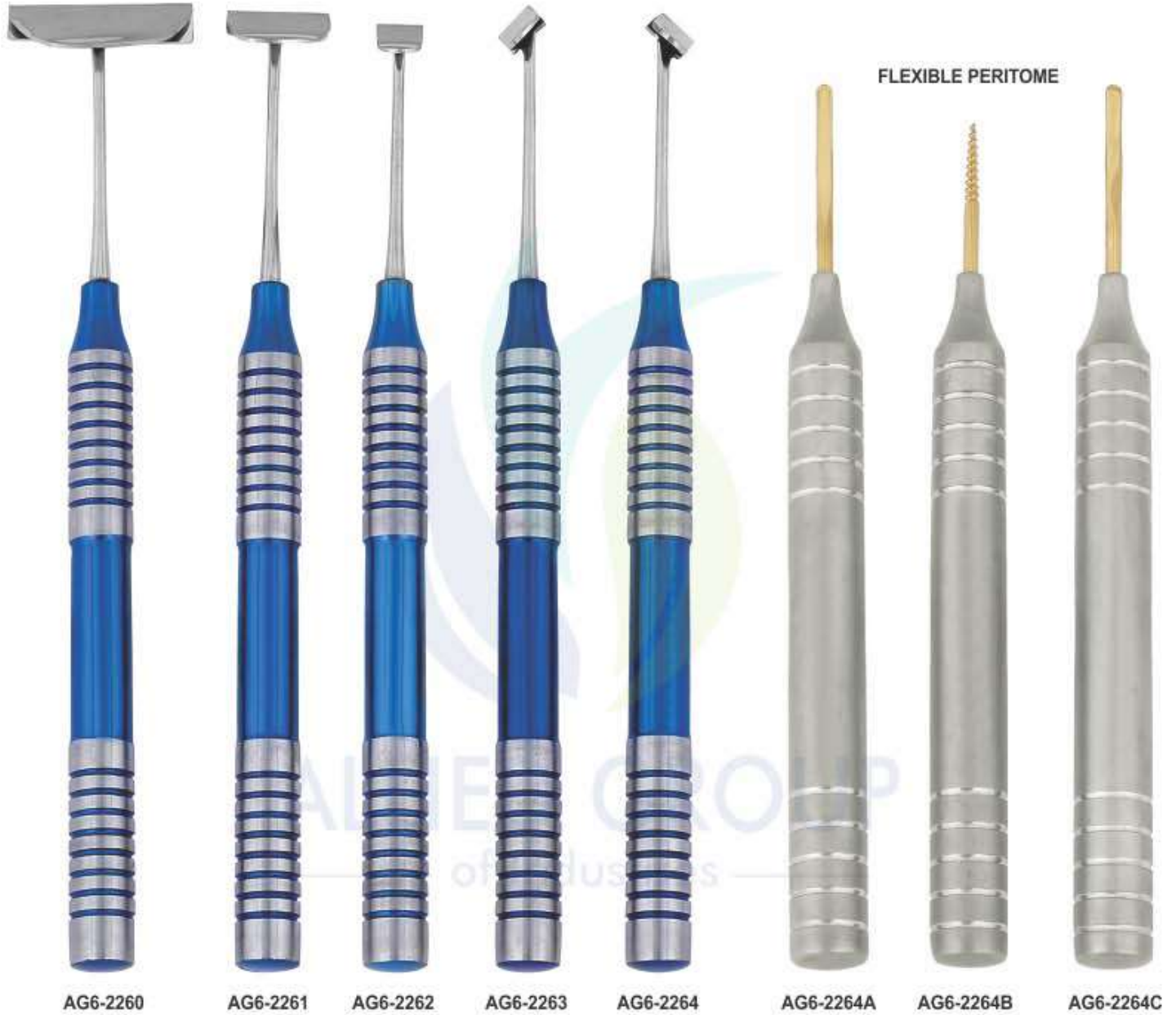

Soft Brushing Kit Set of 6 Pcs





# IMPLANTOLOGY

- Инструменты для имплантологии
  - Implantologie
  - Implantologie
- Инструменти для имплантології
  - Implantologia
  - زراعة الأسنان

## SINUS ELEVATOR & MEMBRANE LIFT TIPS



**AG6-2265**  
Membrane Detach Elevator



**AG6-2266**  
Membrane Elevator



**AG6-2267**  
Membrane Elevator



**AG6-2268**  
Membrane Elevator



**AG6-2269**  
Membrane Elevator



**AG6-2270**  
Bone Graft Packer

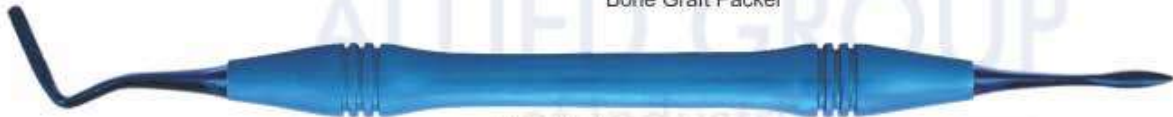

**AG6-2270A** Pt2 Titanium  
A/V Regular



**AG6-2270B** Pt1 Titanium  
A/V Regular



**AG6-2270C** Pt3 Titanium Angel S/E



**AG6-2270D** Pt4 Titanium STR S/E



**AG6-2270E** Pt5 Titanium TG CVD S/E



**AG6-2271**  
Sinus Left Elevator & Membrane Lift Tips 3  
set of 7 Pcs

# IMPLANTOLOGY

- Инструменты для имплантологии
  - Implantologie
  - Implantologie
- Инструменти для имплантології
  - Implantoloia
  - زراعة الأسنان

## SINUS ELEVATOR & MEMBRANE LIFT TIPS



**AG6-2265**  
Membrane Detach Elevator



**AG6-2266**  
Membrane Elevator



**AG6-2267**  
Membrane Elevator



**AG6-2268**  
Membrane Elevator



**AG6-2269**  
Membrane Elevator



**AG6-2270**  
Bone Graft Packer



**AG6-2270A** Pt2 Titanium  
A/V Regular



**AG6-2270B** Pt1 Titanium  
A/V Regular



**AG6-2270C** Pt3 Titanium Angel S/E



**AG6-2270D** Pt4 Titanium STR S/E



**AG6-2270E** Pt5 Titanium TG CVD S/E



**AG6-2271**  
Sinus Left Elevator & Membrane Lift Tips 3  
set of 7 Pcs

## IMPLANTOLOGY

- Инструменты для имплантологии
- Implantologie
- Implantologie
- Инструменти для імплантології
- Implantologia
- زراعة الأسنان

### MIXING SPATULA WITH SHOVEL



**AG6-2272**  
Bone Carrier  
Titanium



**AG6-2273**  
Raspator, Prichard  
Length 180 mm,  
10 mm hollow handle,  
double-ended  
10.5 mm | 4.5 mm,



**AG6-2274**  
Raspator, Prichard  
Length 180 mm,  
10 mm hollow handle,  
double ended



**AG6-2275**  
Raspator, Prichard  
Length 180 mm,  
10 mm hollow handle,  
double-ended  
10.5 mm | 4.5 mm,



**AG6-2276**  
Mixing Spatula  
with shovel  
17cm



**AG6-2277**  
Mixing Spatula  
with shovel  
18.5cm



**AG6-2278**  
Graft Material Spoon  
Concave Tip For  
Larger Grafts

## IMPLANTOLOGY

- Инструменты для имплантологии
  - Implantologie
  - Implantologie
- Инструменти для имплантології
  - Implantologia
  - زراعة الأسنان

### BONE GRAFTING INSTRUMENTS COMPACTOR/TAMPERS

Product offering includes instruments for harvesting, mixing and compacting bone Provides clinicians with the proper instrumentation for bone grafting procedures Weighted bone basin Prevents tipping and spilling of bone and other materials during mixing



**AG6-2279**  
Graft Packer, Concave Tips DE 4/6mm



**AG6-2280**  
Bone Spoon/ Packer DE 3mm



**AG6-2281**  
Blade and pusher Length 180 mm, for straight or angled, blade: 15 x 5 mm, pusher: 4 mm diameter Straight



**AG6-2282**  
Blade and pusher Length 180 mm, for straight or angled, blade: 15 x 5 mm, pusher: 4 mm diameter angular



**AG6-2283**  
Spoon and pusher Length 180 mm, for angled spoon: 10 x 5 mm, pusher: diameter 3 mm



**AG6-2284**  
Graft Packer, Smooth Tips DE 5/8mm

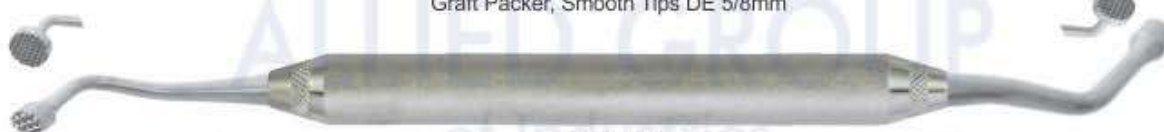

**AG6-2285**  
Graft Packer, Serrated Tips DE 3/4mm



**AG6-2286**  
Graft Packer, Serrated Tips DE 6/8mm



**AG6-2287**  
Titanium graft packer/placement site depth gauge 3.3mm & 4.0mm Diameter tips Marked at 8, 11, 13, 15 & 18mm



**AG6-2288**  
Tamper Length 170 mm, for bone material, double-ended, diameter 3.2 mm (2-4-6-8-10) and diameter 2.5mm (2-4-6-8-10)

## IMPLANTOLOGY

- Инструменты для имплантологии
  - Implantologie
  - Implantologie
- Інструменти для імплантології
  - Implantologia
  - زراعة الأسنان

### SPOON AND PUSHER (TRINOVO)

Trinovo handle, different workers, for bone material, high-grade medical stainless steel, corrosion-resistant



# IMPLANTOLOGY

- Инструменты для имплантологии
- Implantologie
- Implantologie

- Інструменти для імплантології
- Implantoloia
- زراعة الأسنان

**Hollow Handle 10mm Length 170mm**



## IMPLANTOLOGY

- Инструменты для имплантологии
- Implantologie
- Implantologie
- Инструменти для имплантології
- Implantologia
- زراعة الأسنان

### TISSUE MEMBRANE FORCEPS



**AG6-2305**  
Tissue Graft Forcep  
Serrated Teeth



**AG6-2306**  
Self Locking  
Grooved



**AG6-2307**  
Tissue Graft Forcep  
Serrated Teeth



**AG6-2308**  
Titanium  
Locking Plier



**AG6-2309**  
TC Gripper Carbide  
Tipped Tissue Forceps  
Serrated Carbide Tips  
14.5cm



**AG6-2310**  
Adson Carbide  
Tipped Tissue Forceps  
Serrated Carbide Tips  
12cm



**AG6-2311**  
Micor Adson 1x2  
Tissue Forcep 12.1cm  
1x2 Teeth - 0.5mm Tips



**AG6-2312**  
Adson 7x7  
Tissue Forceps  
7x7 Teeth 12cm



**AG6-2313**  
Adson 7x7 Curved  
Tissue Forceps  
7x7 Teeth 12cm



**AG6-2314**  
Suture Pliers  
Suture Forceps with  
1.6mm Ring Tip



**AG6-2315**  
Debakey Atraumatic  
Tissue Forceps Straight  
Serrated Teeth  
16cm



**AG6-2316**  
Debakey Atraumatic  
Tissue Forceps Curved  
Serrated Teeth  
16cm

# IMPLANTOLOGY

- Инструменты для имплантологии
  - Implantologie
  - Implantologie
- Инструменти для имплантології
  - Implantologia
  - زراعة الأسنان

## TISSUE MEMBRANE FORCEPS



**AG6-2317**  
Russian Long  
Tissue Forceps  
Serrated Tip  
20cm



**AG6-2318**  
Russian  
Tissue Forceps  
Serrated Tip  
15cm



**AG6-2319**  
Tissue Punch Forceps  
To Remove Tissue  
After Using Punch



**AG6-2320**  
13.5 cm  
narrow



**AG6-2321**  
10.5 cm  
**Membrane tweezers KUEHNE**



**AG6-2322**  
13.5 cm  
wide



**AG6-2323**  
**Pin-Tweezers**  
with or without lock,  
length 15 cm,  
with lock



**AG6-2324**  
without lock



**AG6-2325**  
**Haltepinzette with lock**  
15,5 cm, for pins, towards  
the tips, etc



**AG6-2326**  
Carry Forceps  
15cm



**AG6-2327**  
Carry Forceps  
15cm



**AG6-2328**  
Carry Forceps  
15cm



## IMPLANTOLOGY

- Инструменты для имплантологии
- Implantologie
- Implantologie
- Инструменти для імплантології
- Implantologia
- زراعة الأسنان

### OSTEOTOME CONVEXES / CONCAVE / CONIQUES

CONVEXES



**AG6-2329**  
SET OF 5 PIECES

CONCAVES

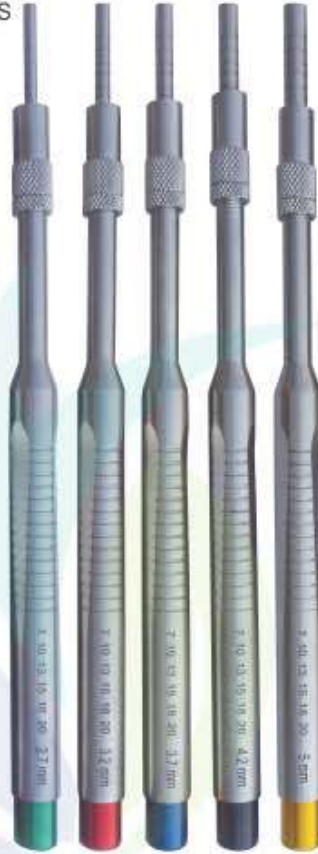





**AG6-2330**  
SET OF 5 PIECES

CONIQUES

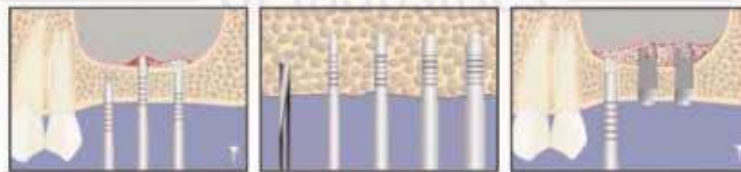

**AG6-2331**  
SET OF 5 PIECES



|   |                   |                 |         |         |         |         |       |
|---|-------------------|-----------------|---------|---------|---------|---------|-------|
|  | CONVEXES STRAIGHT | <b>AG6-2329</b> | 2,7 Ømm | 3,2 Ømm | 3,7 Ømm | 4,2 Ømm | 5 Ømm |
|  | CONCAVES STRAIGHT | <b>AG6-2330</b> | 2,7 Ømm | 3,2 Ømm | 3,7 Ømm | 4,2 Ømm | 5 Ømm |
|  | CONIQUES STRAIGHT | <b>AG6-2331</b> | 2,7 Ømm | 3,2 Ømm | 3,7 Ømm | 4,2 Ømm | 5 Ømm |

# IMPLANTOLOGY

- Инструменты для имплантологии
  - Implantologie
  - Implantologie
- Инструменти для имплантології
  - Implantoloia
  - زراعة الأسنان

## OSTEOTOME CONVEXES / CONCAVE / CONIQUES

CONVEXES



**AG6-2332**  
SET OF 5 PIECES

CONCAVES







**AG6-2333**  
SET OF 5 PIECES

CONIQUES

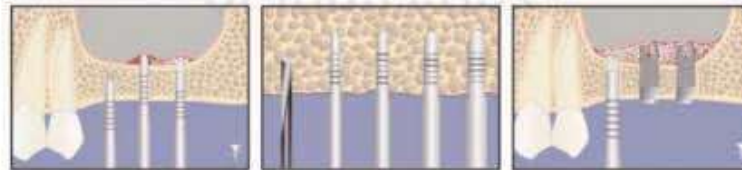

**AG6-2334**  
SET OF 5 PIECES



|   |                 |                 |         |         |         |         |       |
|---|-----------------|-----------------|---------|---------|---------|---------|-------|
|  | CONVEXES CURVED | <b>AG6-2332</b> | 2,7 Ømm | 3,2 Ømm | 3,7 Ømm | 4,2 Ømm | 5 Ømm |
|  | CONCAVES CURVED | <b>AG6-2333</b> | 2,7 Ømm | 3,2 Ømm | 3,7 Ømm | 4,2 Ømm | 5 Ømm |
|  | CONIQUES CURVED | <b>AG6-2334</b> | 2,7 Ømm | 3,2 Ømm | 3,7 Ømm | 4,2 Ømm | 5 Ømm |

## IMPLANTOLOGY

- Инструменты для имплантологии
  - Implantologie
  - Implantologie
- Інструменти для імплантології
  - Implantologia
  - زراعة الأسنان

### BONE SCRAPER STRAIGHT & CURVED



**AG6-2335**  
Bone Scraper  
Straight

**AG6-2336**  
Bone Scraper  
Curved

### TISSUE PUNCH STRAIGHT & CURVED



**Tissue Punch**  
Straight

**Tissue Punch**  
Curved

**ALLIED GROUP**  
of Industries

Ø4.0   Ø5.0   Ø6.0   Ø7.0



**AG6-2349**  
Tissue Punch with pin  
Set of Four Pieces



**AG6-2350**  
Tissue Punch  
Set of Five Pieces



**AG6-2351**  
Tissue Punch  
Set of Five Pieces

# IMPLANTOLOGY

- Инструменты для имплантологии
  - Implantologie
  - Implantologie
- Инструменти для имплантології
  - Implantoloia
  - زراعة الأسنان

## BONE MILL BONE WELL

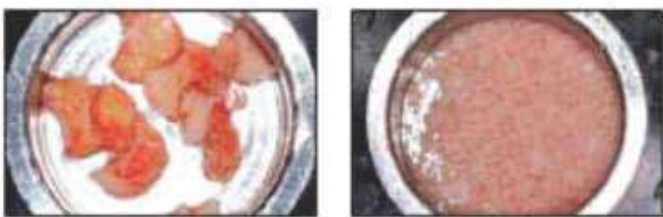

## IMPLANTOLOGY

- Инструменты для имплантологии
- Implantologie
- Implantologie
- Инструменти для імплантології
- Implantologia
- زراعة الأسنان

### TREPHINE

Burs with depth markings are suited for precise and simple transplantation of cylindrical bone grafts as well as for all other bone-extraction tasks.



**AG6-2367**  
Trepine Drill  
Set of Eight Pieces



**AG6-2368**  
Trepine Drill  
Set of Eight Pieces

### BONE INJECTORS, COLLECTORS & SUCTION TUBE



# IMPLANTOLOGY

- Инструменты для имплантологии
  - Implantologie
  - Implantologie
- Инструменти для имплантології
  - Implantoloia
  - زراعة الأسنان

## BONE EXPANDER SCREW & SURGICAL KITS



Ø2.0mm    Ø2.5mm    Ø2.8mm

**AG6-2377** Short Implant Drills



Ø3.2mm    Ø3.65mm    Ø4.2mm    Ø5.2mm

**AG6-2378** Long Implant Drills



**AG6-2379**

Bone Universal Kit

Drill: 2mm, 2.8mm, 3.2mm, 3.65mm, 4.2mm, 4.5mm, 4.8mm, 5.2mm  
 Trephines Bit: 3.0mm, 4.0mm, 5.0mm, 6.0mm, 7.0mm, 8.0mm, 9.0mm, 10mm.  
 Driver: 2.5mm, 2.5mm Hand Pcs, 1.25mm, 1.25mm Hand Pcs  
 Short Driver 2.5mm, Long Driver 2.5mm  
 1.25mm, Short Hex Driver Hand Pcs  
 1.25mm, Long Hex Driver Hand Pcs, Torque Wrench 4.0mm



**AG6-2380**

Bone Expander Kit

Expander: 2.6mm, 3.0mm, 3.4mm, 3.8mm, 4.3mm  
 Ratchet Driver, Parallel Pin  
 Pilot Drill, Drill 1.4mm, Drill Driver 4mm  
 Hand Driver 4mm, Ratchet 4.0mm



**AG6-2381**

Bone Universal Kit

Drill: 2mm, 2.8mm, 3.2mm, 3.65mm,  
 4.2mm, 4.5mm, 4.8mm, 5.2mm  
 Trephines Bit:  
 3.0mm, 4.0mm, 5.0mm, 6.0mm,  
 7.0mm, 8.0mm, 9.0mm, 10mm.

Bone Compression:  
 2mm, 3.3mm, 2.8mm, 4.2mm, 3mm, 3.5mm  
 Driver:  
 2.5mm, 2.5mm Hand Pcs  
 1.25mm, 1.25mm Hand Pcs  
 Short Driver 2.5mm  
 Long Driver 2.5mm  
 1.25mm, Short Hex Driver Hand Pcs  
 1.25mm, Long Hex Driver Hand Pcs  
 Torque Wrench 6.35mm 1 Pcs



**AG6-2382**

Bone Universal Kit

Conical Drills: 20 Pcs  
 Tissue Punches:  
 3.0mm, 3.50mm, 4.0mm, 4.5mm,  
 5.0mm, 6.0mm, 6.50mm  
 Bone Expander:  
 1.6/3.8mm, 1.9/3.0mm, 2.1/3.6mm,  
 2.6/3.8mm, 2.9/4.3mm  
 Drill Adapter: 1 Pcs  
 1.25mm, 2.50mm Hex Driver Hand Pcs

Pilot Drill: 1.6mm  
 Drill Bit: 1.4mm, 1.6mm, 1.8mm, 2.0mm, 2.2mm  
 Ratchet Driver: 4mm/6.35, 1.25/2.50  
 Rimer: 3.2/4.7mm, 3.7/4.7mm  
 Parallel Pin: 4.5mm, 2.5mm  
 Double step Drill: 2.4/2.8mm  
 Depth Gauge: 1 Pcs  
 Torque Wrench 6.35mm Universal: 1 Pcs

## IMPLANTOLOGY

- Инструменты для имплантологии
- Implantologie
- Implantologie
- Инструменти для імплантології
- Implantologia
- زراعة الأسنان

### KEYS FOR IMPLANT SCREW



AG6-2383



AG6-2384



AG6-2385



AG6-2386

### TORQUE WRENCH & RATCHET



AG6-2387 Star Torque Wrench 6.35mm Universal



AG6-2388 Round Torque Wrench 4.0mm Universal



AG6-2389 Hex Driver With 4.0mm Driver



AG6-2390 Star Torque Wrench 6.35mm Universal



AG6-2391 Hex Torque Wrench 4.00mm Universal



AG6-2392 Star Torque Wrench 6.35mm Universal



AG6-2393 Star Torque Wrench 6.35mm Universal



AG6-2394 Star Torque Wrench 6.35mm Universal



AG6-2395 Star Torque Wrench 6.35mm Universal



AG6-2396 Star Torque Wrench 6.35mm Universal



AG6-2397 Star Ratchet Wrench 6.35mm Universal



AG6-2398 Star Ratchet Wrench 6.35mm Universal



AG6-2399 Star Ratchet Wrench 6.35mm Universal



AG6-2400 Star Ratchet Wrench 4.0mm Universal



AG6-2401 Round Ratchet Wrench 4.0mm Universal



AG6-2402 Round Ratchet Wrench 3.35mm Universal



AG6-2403 Star Ratchet Wrench 4.0mm Universal



AG6-2404 Star Ratchet Wrench 6.35mm Universal

# IMPLANTOLOGY

- Инструменты для имплантологии
- Implantologie
- Implantologie

- Инструменти для імплантології
- Implantologia
- زراعة الأسنان



**AG6-2405**  
Suction Cannula Kit  
with 3 Needles



Suction Pipe



Suction Needle  
1mm



Suction Needle  
1.5mm



Suction Needle  
2mm



2cm

2.7cm

With Filter

**AG6-2406**  
17.5cm

**AG6-2407**  
18cm

**AG6-2408**  
Suction tubes  
to collect  
the extracted  
bone material  
180mm  
coarse  
Ø 5mm



**AG6-2409**  
fine  
Ø 9mm

1.5mm 3mm 5mm



**AG6-2410**  
Suction  
Tubes  
180mm

**AG6-2411**  
Suction  
Tubes  
180mm

**AG6-2412**  
Suction  
Tubes  
180mm



**AG6-2414**  
Ø 3 mm  
length 180mm  
**AG6-2415**  
Ø 4 mm  
length 180mm  
**AG6-2416**  
Ø 5 mm  
length 180mm

**AG6-2413**  
Fig. 6FR  
Frazier  
15 cm - Ø 2 mm



## IMPRESSION TRAYS

- Оттисковые ложки
  - Porte-empreinte
  - Abdrucklöffel
- Відбиткові ложки
  - Cubetas para impresiones
  - صواني الانطباع

### PERFORATED WITH RIM LOCK

Set of 06 Pcs

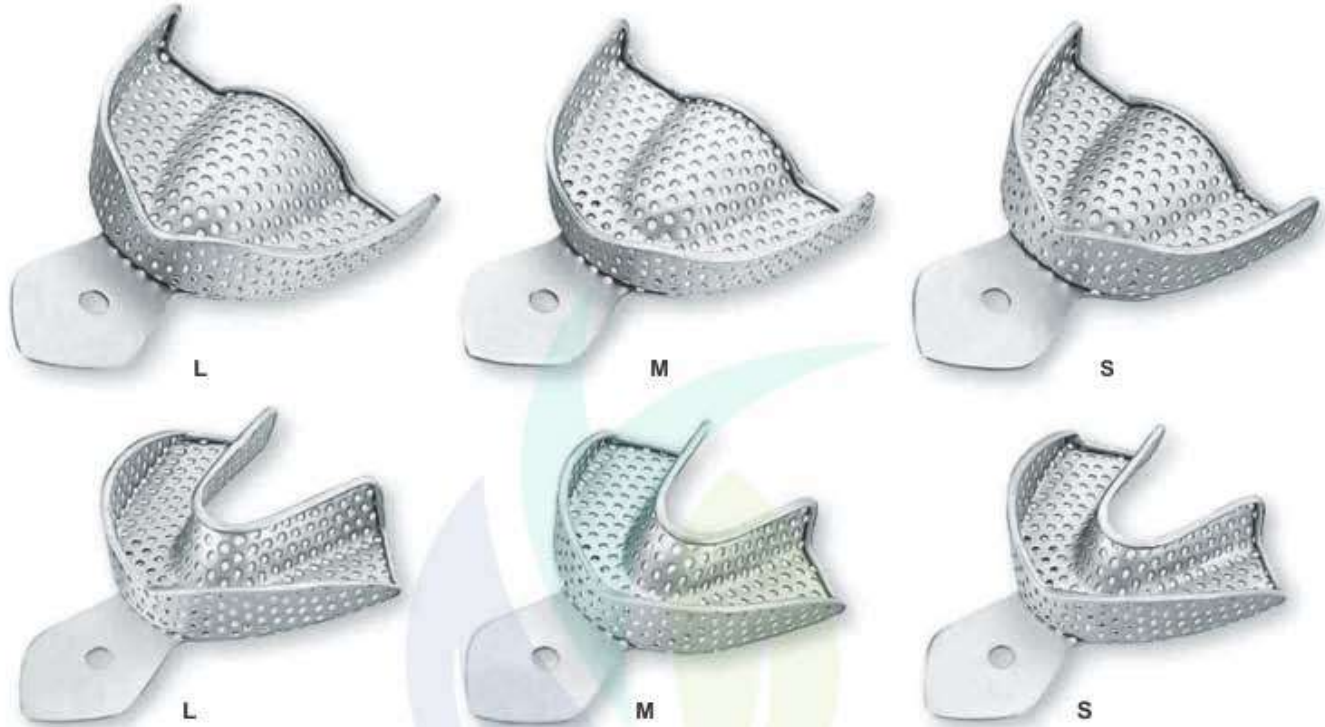

#### AG7-2417 SET OF 06 PCS

Upper: S, M, L  
Lower: S, M, L

### PERFORATED WITH RIM LOCK

Set of 8 Pcs



#### AG7-2418 SET OF 08 PCS

Upper: XS, S, M, L  
Lower: XS, S, M, L

#### AG7-2419 SET OF 08 PCS

Upper: S, M, L, XL  
Lower: S, M, L, XL

#### AG7-2420 SET OF 10 PCS

Upper: XS, S, M, L, XL  
Lower: XS, S, M, L, XL

## IMPRESSION TRAYS

- Оттисные ложки
- Porte-empreinte
- Abdrucklöffel

- Відбиткові ложки
- Cubetas para impresiones
- صواني الانطباع

### SOLID WITH RIM LOCK

Set of 6 Pcs



### AG7-2421 SET OF 06 PCS

Upper: S, M, L  
Lower: S, M, L

### SOLID WITH RIM LOCK

Set of 8 Pcs



### AG7-2422 SET OF 08 PCS

Upper: XS, S, M, L  
Lower: XS, S, M, L

### AG7-2423 SET OF 08 PCS

Upper: S, M, L, XL  
Lower: S, M, L, XL

### AG7-2424 SET OF 10 PCS

Upper: XS, S, M, L, XL  
Lower: XS, S, M, L, XL

## IMPRESSION TRAYS

- Оттисные ложки
  - Porte-empreinte
  - Abdrucklöffel
- Відбиткові ложки
  - Cubetas para impresiones
  - صواني الاطباع

### PERFORATED FULL DENTURE

Set of 8 Pcs

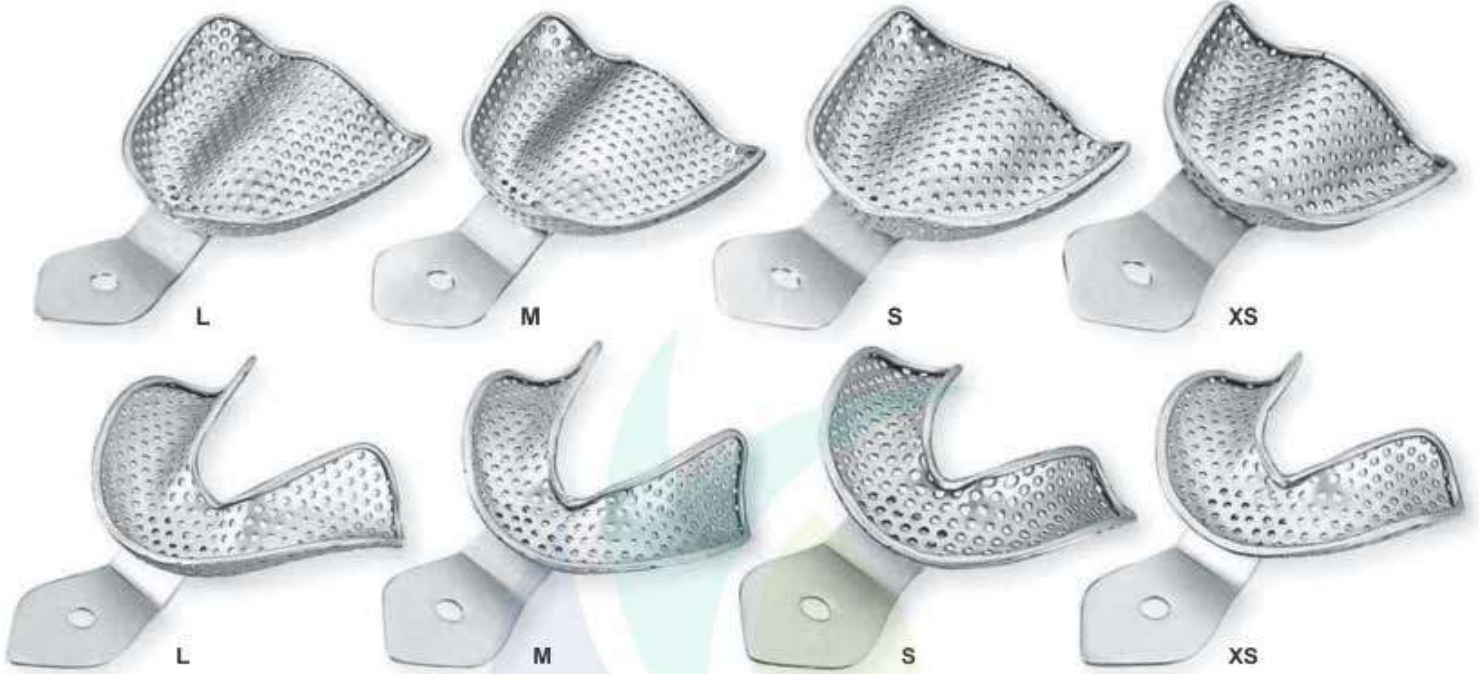

**AG7-2425 SET OF 08 PCS**  
Upper: S, M, L, XL  
Lower: S, M, L, XL

**AG7-2426 SET OF 08 PCS**  
Upper: S, M, L  
Lower: S, M, L

### SOLID FULL DENTURE

Set of 8 Pcs



**AG7-2427 SET OF 08 PCS**  
Upper: S, M, L, XL  
Lower: S, M, L, XL

**AG7-2428 SET OF 06 PCS**  
Upper: S, M, L  
Lower: S, M, L

## IMPRESSION TRAYS

- Оттисные ложки
  - Porte-empreinte
  - Abdrucklöffel
- Відбиткові ложки
  - Cubetas para impresiones
  - صواني الاطباق

### Perforated Without Rim Lock



### Solid With Rim Lock



## HOLLOWWARE INSTRUMENTS



# HOLLOWARE INSTRUMENTS



**Scalers Tray**  
AG8-2500 200 x 100 mm



**Scalers Trays**  
AG8-2501 205 x 115 x 17 mm  
AG8-2502 205 x 152 x 17 mm  
AG8-2503 290 x 115 x 17 mm



**Instruments Trays**  
AG8-2504 200 x 110 x 30 mm  
AG8-2505 215 x 115 x 35 mm  
AG8-2506 220 x 130 x 30 mm  
AG8-2507 230 x 125 x 35 mm  
AG8-2508 245 x 140 x 40 mm  
AG8-2509 285 x 160 x 45 mm  
AG8-2510 315 x 175 x 50 mm  
AG8-2511 330 x 185 x 50 mm



**Instruments Trays**  
AG8-2512 150 x 100 x 50 mm  
AG8-2513 200 x 100 x 50 mm  
AG8-2514 220 x 120 x 50 mm  
AG8-2515 240 x 140 x 50 mm  
AG8-2516 200 x 150 x 50 mm  
AG8-2517 250 x 200 x 50 mm  
AG8-2518 300 x 250 x 50 mm  
AG8-2519 300 x 200 x 50 mm  
AG8-2520 350 x 250 x 50 mm  
AG8-2521 400 x 300 x 50 mm  
AG8-2522 450 x 300 x 50 mm  
AG8-2523 450 x 350 x 50 mm



**Instruments Trays With Lid**  
AG8-2524 150 x 100 x 50 mm  
AG8-2525 200 x 100 x 50 mm  
AG8-2526 220 x 120 x 50 mm  
AG8-2527 240 x 140 x 50 mm  
AG8-2528 200 x 150 x 50 mm  
AG8-2529 250 x 200 x 50 mm  
AG8-2530 300 x 250 x 50 mm  
AG8-2531 300 x 200 x 50 mm  
AG8-2532 350 x 250 x 50 mm  
AG8-2533 400 x 300 x 50 mm  
AG8-2534 450 x 300 x 50 mm  
AG8-2535 450 x 350 x 50 mm

ALLIED GROUP  
of Industries



**Mayo Tray Perforated**  
AG8-2536 150 x 100 x 25 mm  
AG8-2537 200 x 100 x 25 mm  
AG8-2538 220 x 120 x 25 mm  
AG8-2539 240 x 140 x 25 mm  
AG8-2540 200 x 150 x 25 mm  
AG8-2541 250 x 200 x 25 mm  
AG8-2542 300 x 250 x 25 mm  
AG8-2543 300 x 200 x 25 mm  
AG8-2544 350 x 250 x 25 mm  
AG8-2545 400 x 300 x 25 mm  
AG8-2546 450 x 300 x 25 mm  
AG8-2547 450 x 350 x 25 mm



**Scaler Tray**  
AG8-2548 200 x 115 mm  
AG8-2549 205 x 150 mm  
AG8-2550 290 x 150 mm  
AG8-2551 300 x 200 mm



**Instruments Tray Perforated**  
AG8-2552 150 x 100 x 50 mm  
AG8-2553 200 x 100 x 50 mm  
AG8-2554 220 x 120 x 50 mm  
AG8-2555 240 x 140 x 50 mm  
AG8-2556 200 x 150 x 50 mm  
AG8-2557 250 x 200 x 50 mm  
AG8-2558 300 x 250 x 50 mm  
AG8-2559 300 x 200 x 50 mm  
AG8-2560 350 x 250 x 50 mm  
AG8-2561 400 x 300 x 50 mm  
AG8-2562 450 x 300 x 50 mm  
AG8-2563 450 x 350 x 50 mm

## HOLLOWARE INSTRUMENTS

### Sterilizing boxes & instruments Trays



**Instruments Box with Hooks**  
**AG8-2564** 170 x 70 x 30 mm  
**AG8-2565** 180 x 80 x 40 mm  
**AG8-2566** 200 x 100 x 40 mm  
**AG8-2567** 200 x 100 x 50 mm  
**AG8-2568** 220 x 120 x 50 mm  
**AG8-2569** 250 x 150 x 50 mm  
**AG8-2570** 250 x 200 x 50 mm  
**AG8-2571** 300 x 150 x 60 mm  
**AG8-2572** 300 x 200 x 50 mm  
**AG8-2573** 350 x 250 x 50 mm  
**AG8-2574** 400 x 200 x 100 mm  
**AG8-2575** 450 x 250 x 50 mm



**Instruments Box**  
**AG8-2576** 170 x 70 x 30 mm  
**AG8-2577** 180 x 80 x 40 mm  
**AG8-2578** 200 x 100 x 40 mm  
**AG8-2579** 200 x 100 x 50 mm  
**AG8-2580** 220 x 120 x 50 mm  
**AG8-2581** 250 x 150 x 50 mm  
**AG8-2582** 250 x 200 x 50 mm  
**AG8-2583** 300 x 150 x 60 mm  
**AG8-2584** 300 x 200 x 50 mm  
**AG8-2585** 350 x 250 x 50 mm  
**AG8-2586** 400 x 200 x 100 mm  
**AG8-2587** 450 x 250 x 50 mm



**Instruments Box Perforated**  
**AG8-2588** 170 x 70 x 30 mm  
**AG8-2589** 180 x 80 x 40 mm  
**AG8-2590** 200 x 100 x 40 mm  
**AG8-2591** 200 x 100 x 50 mm  
**AG8-2592** 220 x 120 x 50 mm  
**AG8-2593** 250 x 150 x 50 mm  
**AG8-2594** 250 x 200 x 50 mm  
**AG8-2595** 300 x 150 x 60 mm  
**AG8-2596** 300 x 200 x 50 mm  
**AG8-2597** 350 x 250 x 50 mm  
**AG8-2598** 400 x 200 x 100 mm  
**AG8-2599** 450 x 250 x 50 mm



**Gloves Box**  
**AG8-2600** 300 x 150 mm



**Catheters Tray with lid**  
**AG8-2601** 200 x 60 x 40 mm  
**AG8-2602** 200 x 90 x 40 mm  
**AG8-2603** 320 x 95 x 50 mm  
**AG8-2604** 328 x 90 x 50 mm  
**AG8-2605** 365 x 90 x 50 mm  
**AG8-2606** 440 x 115 x 50 mm



**Box With Filter**  
**AG8-2607** 100 x 50 mm  
**AG8-2608** 250 x 150 mm  
**AG8-2609** 150 x 65 mm  
**AG8-2610** 200 x 100 mm  
**AG8-2611** 300 x 200 mm



**Instruments Trays With Cover**  
**AG8-2612** 210 x 110 x 50 mm  
**AG8-2613** 240 x 160 x 50 mm  
**AG8-2614** 300 x 180 x 50 mm  
**AG8-2615** 360 x 210 x 50 mm  
**AG8-2616** 400 x 230 x 55 mm

**Instruments Trays Without Cover**  
**AG8-2617** 210 x 110 x 50 mm  
**AG8-2618** 240 x 160 x 50 mm  
**AG8-2619** 300 x 180 x 50 mm  
**AG8-2620** 360 x 210 x 50 mm  
**AG8-2621** 400 x 230 x 55 mm



**Instruments Box with lid**  
**AG8-2622** 170 x 70 x 30 mm  
**AG8-2623** 180 x 80 x 40 mm  
**AG8-2624** 200 x 100 x 40 mm  
**AG8-2625** 200 x 100 x 50 mm  
**AG8-2626** 220 x 120 x 50 mm  
**AG8-2627** 250 x 150 x 50 mm  
**AG8-2628** 250 x 200 x 50 mm  
**AG8-2629** 300 x 150 x 60 mm  
**AG8-2630** 300 x 200 x 50 mm  
**AG8-2631** 350 x 250 x 50 mm  
**AG8-2632** 400 x 200 x 100 mm  
**AG8-2633** 450 x 250 x 50 mm

# HOLLOWARE INSTRUMENTS



**Kidney Tray**  
AG8-2634 160 mm  
AG8-2635 200 mm  
AG8-2636 250 mm  
AG8-2637 280 mm  
AG8-2638 300 mm



**Kidney Tray Shallow**  
AG8-2639 170 mm  
AG8-2640 220 mm  
AG8-2641 240 mm



**Kidney Tray With Cover**  
AG8-2642 160 mm  
AG8-2643 200 mm  
AG8-2644 250 mm  
AG8-2645 280 mm  
AG8-2646 300 mm



**Kidney Tray**  
AG8-2647 160 mm  
AG8-2648 200 mm  
AG8-2649 250 mm  
AG8-2650 280 mm  
AG8-2651 300 mm



**Forceps Jars**  
AG8-2652 30 x 90 mm  
AG8-2653 50 x 100 mm  
AG8-2654 50 x 130 mm  
AG8-2655 50 x 175 mm  
AG8-2656 75 x 100 mm  
AG8-2657 75 x 130 mm  
AG8-2658 75 x 175 mm  
AG8-2659 100 x 175 mm  
AG8-2660 100 x 200 mm



**Methot Jar Without Lid**  
AG8-2661



**Dressing Jar / Cotton Container**  
AG8-2662 80 x 80 mm  
AG8-2663 100 x 60 mm  
AG8-2664 100 x 80 mm  
AG8-2665 100 x 100 mm  
AG8-2666 120 x 80 mm  
AG8-2667 120 x 100 mm  
AG8-2668 150 x 100 mm  
AG8-2669 150 x 150 mm  
AG8-2670 180 x 150 mm  
AG8-2671 180 x 180 mm  
AG8-2672 200 x 200 mm  
AG8-2673 240 x 240 mm



**Sputum Cup**  
AG8-2674



**Dressing Jar With Lid & Knob**  
AG8-2675 80 x 80 mm  
AG8-2676 90 x 90 mm  
AG8-2677 100 x 100 mm  
AG8-2678 120 x 120 mm  
AG8-2679 100 x 130 mm  
AG8-2680 150 x 150 mm  
AG8-2681 125 x 170 mm



**Round Bowls**  
AG8-2682 80 x 35 mm  
AG8-2683 125 x 60 mm



## HOLLOWWARE INSTRUMENTS



Spirit Lamp  
AG8-2684



Spirit Lamp  
AG8-2685



Spirit Lamp  
AG8-2686



Cotton Holding Jar  
AG8-2687



Cotton Holder  
AG8-2688



Cotton Holder  
AG8-2689



Cotton Wool Dispenser Acc.  
to Methol  
AG8-2690

ALLIED GROUP  
of Industries



Needle Sterilization Tub  
AG8-2691



Round Endodontic Boxes  
complete with lid  
AG8-2692 Ø mm. 94 - h. mm. 70



Endodontic Box  
AG8-2693

# HOLLOWARE INSTRUMENTS



**AG8-2694**  
100 x 180 x 11mm  
Mini size



**AG8-2695**  
100 x 180 x 11mm  
Mini size



**AG8-2696**  
100 x 180 x 11mm  
Mini size



**AG8-2697**  
100 x 180 x 11mm  
Mini size



**AG8-2698**  
100 x 180 x 11mm  
Mini size



Lid  
Coperchio  
**AG8-2699**  
103 x 182 x 10mm  
Mini size



**AG8-2700**  
Silver



**AG8-2701** Blue  
**AG8-2702** Red



**AG8-2703** Blue  
**AG8-2704** Red



**AG8-2705**  
Silver



**AG8-2706**  
Green



**AG8-2708**  
Blue



**AG8-2707**  
Golden



**AG8-2709**  
Red



**AG8-2710**  
Silver



**AG8-2711**  
Midi  
125 x 105 x 54mm



**AG8-2712**  
Maxi  
204 x 105 x 54mm

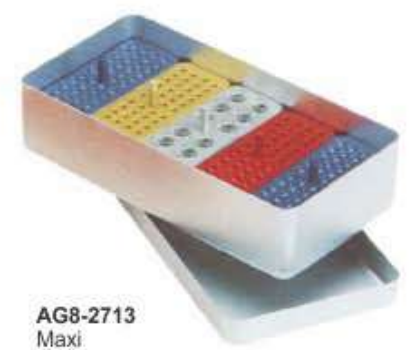

**AG8-2713**  
Maxi  
204 x 105 x 54mm



### Round Sterilizer Drum

|          |                   |
|----------|-------------------|
| AG8-2714 | mm. Ø 80 x 80 H   |
| AG8-2715 | mm. Ø 125 x 80 H  |
| AG8-2716 | mm. Ø 125 x 100 H |
| AG8-2717 | mm. Ø 125 x 125 H |
| AG8-2718 | mm. Ø 150 x 80 H  |
| AG8-2719 | mm. Ø 150 x 100 H |
| AG8-2720 | mm. Ø 150 x 130 H |
| AG8-2721 | mm. Ø 150 x 150 H |
| AG8-2722 | mm. Ø 150 x 190 H |
| AG8-2723 | mm. Ø 190 x 125 H |
| AG8-2724 | mm. Ø 190 x 145 H |
| AG8-2725 | mm. Ø 190 x 165 H |
| AG8-2726 | mm. Ø 190 x 190 H |
| AG8-2727 | mm. Ø 190 x 240 H |
| AG8-2728 | mm. Ø 190 x 290 H |
| AG8-2729 | mm. Ø 240 x 120 H |
| AG8-2730 | mm. Ø 240 x 145 H |
| AG8-2731 | mm. Ø 240 x 165 H |
| AG8-2732 | mm. Ø 240 x 190 H |
| AG8-2733 | mm. Ø 240 x 240 H |
| AG8-2734 | mm. Ø 240 x 290 H |
| AG8-2735 | mm. Ø 240 x 340 H |
| AG8-2736 | mm. Ø 240 x 390 H |
| AG8-2737 | mm. Ø 290 x 145 H |
| AG8-2738 | mm. Ø 290 x 165 H |
| AG8-2739 | mm. Ø 290 x 190 H |
| AG8-2740 | mm. Ø 290 x 240 H |
| AG8-2741 | mm. Ø 290 x 290 H |
| AG8-2742 | mm. Ø 290 x 340 H |
| AG8-2743 | mm. Ø 290 x 390 H |
| AG8-2744 | mm. Ø 340 x 145 H |
| AG8-2745 | mm. Ø 340 x 165 H |
| AG8-2746 | mm. Ø 340 x 190 H |
| AG8-2747 | mm. Ø 340 x 240 H |
| AG8-2748 | mm. Ø 340 x 290 H |
| AG8-2749 | mm. Ø 340 x 340 H |
| AG8-2750 | mm. Ø 340 x 390 H |
| AG8-2751 | mm. Ø 390 x 140 H |
| AG8-2752 | mm. Ø 390 x 165 H |
| AG8-2753 | mm. Ø 390 x 190 H |
| AG8-2754 | mm. Ø 390 x 240 H |
| AG8-2755 | mm. Ø 390 x 290 H |
| AG8-2756 | mm. Ø 390 x 340 H |
| AG8-2757 | mm. Ø 390 x 390 H |
| AG8-2758 | mm. Ø 390 x 490 H |



### Round Sterilizer Drums "Filter"

|          |                   |
|----------|-------------------|
| AG8-2759 | mm. Ø 80 x 80 H   |
| AG8-2760 | mm. Ø 125 x 80 H  |
| AG8-2761 | mm. Ø 125 x 100 H |
| AG8-2762 | mm. Ø 125 x 125 H |
| AG8-2763 | mm. Ø 150 x 100 H |
| AG8-2764 | mm. Ø 150 x 130 H |
| AG8-2765 | mm. Ø 150 x 150 H |
| AG8-2766 | mm. Ø 150 x 190 H |
| AG8-2767 | mm. Ø 190 x 145 H |
| AG8-2768 | mm. Ø 190 x 165 H |
| AG8-2769 | mm. Ø 190 x 190 H |
| AG8-2770 | mm. Ø 190 x 240 H |
| AG8-2771 | mm. Ø 240 x 145 H |
| AG8-2772 | mm. Ø 240 x 165 H |
| AG8-2773 | mm. Ø 240 x 190 H |
| AG8-2774 | mm. Ø 240 x 240 H |
| AG8-2775 | mm. Ø 240 x 290 H |
| AG8-2776 | mm. Ø 240 x 340 H |
| AG8-2777 | mm. Ø 240 x 390 H |
| AG8-2778 | mm. Ø 290 x 145 H |
| AG8-2779 | mm. Ø 290 x 165 H |
| AG8-2780 | mm. Ø 290 x 190 H |
| AG8-2781 | mm. Ø 290 x 240 H |
| AG8-2782 | mm. Ø 290 x 290 H |
| AG8-2783 | mm. Ø 290 x 340 H |
| AG8-2784 | mm. Ø 290 x 390 H |
| AG8-2785 | mm. Ø 340 x 145 H |
| AG8-2786 | mm. Ø 340 x 165 H |
| AG8-2787 | mm. Ø 340 x 190 H |
| AG8-2788 | mm. Ø 340 x 240 H |
| AG8-2789 | mm. Ø 340 x 290 H |
| AG8-2790 | mm. Ø 390 x 140 H |
| AG8-2791 | mm. Ø 390 x 165 H |
| AG8-2792 | mm. Ø 390 x 190 H |
| AG8-2793 | mm. Ø 390 x 240 H |
| AG8-2794 | mm. Ø 390 x 290 H |
| AG8-2795 | mm. Ø 390 x 340 H |
| AG8-2796 | mm. Ø 390 x 490 H |



### Round Bowls With Cover

|          |                  |
|----------|------------------|
| AG8-2797 | Ø 40 mm ml.30    |
| AG8-2798 | Ø 60 mm ml.50    |
| AG8-2799 | Ø 80 mm ml.150   |
| AG8-2800 | Ø 100 mm ml.250  |
| AG8-2801 | Ø 120 mm ml.450  |
| AG8-2802 | Ø 150 mm ml.750  |
| AG8-2803 | Ø 180 mm ml.1500 |
| AG8-2804 | Ø 200 mm ml.2100 |
| AG8-2805 | Ø 250 mm ml.3500 |

### Round Bowls With Out Cover

|          |                  |
|----------|------------------|
| AG8-2806 | Ø 40 mm ml.30    |
| AG8-2807 | Ø 60 mm ml.50    |
| AG8-2808 | Ø 80 mm ml.150   |
| AG8-2809 | Ø 100 mm ml.250  |
| AG8-2810 | Ø 120 mm ml.450  |
| AG8-2811 | Ø 150 mm ml.750  |
| AG8-2812 | Ø 180 mm ml.1500 |
| AG8-2813 | Ø 200 mm ml.2100 |
| AG8-2814 | Ø 250 mm ml.3500 |

# HOLLOWARE INSTRUMENTS

## INSTRUMENTS MANAGEMENT SYSTEM

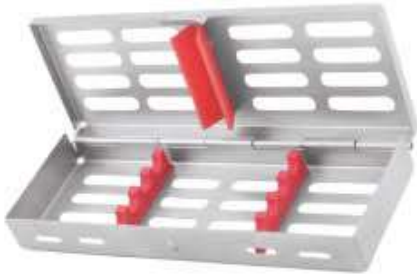

**Cassette For 4 Instruments**  
AG8-2815



**Cassette For 5 Instruments**  
AG8-2816



**Cassette For 6 Instruments**  
AG8-2817



**Cassette For 7 Instruments**  
AG8-2818



**Cassette For 10 Instruments**  
AG8-2819



**Cassette For 20 Instruments**  
AG8-2820



**Cassette For Extraction Forceps**  
AG8-2821



**Cassette For Root Elevator**  
AG8-2822



**AG8-2823**  
Cassette Tray  
15 Pcs



**AG8-2824**  
Cassette Tray  
15 Pcs

## HOLLOWARE INSTRUMENTS

### STERILIZING MESH TRAY

Different sizes & dimensions are available at buyer's demand



**MESH TRAYS**  
**AG8-2825**

Different sizes & dimensions are available at buyer's demand



**MESH TRAYS**  
**AG8-2826**  
05 Pcs



**MESH TRAYS**  
**AG8-2827**  
07 Pcs



**MESH TRAYS**  
**AG8-2828**  
10 Pcs



**MESH TRAYS**  
**AG8-2829**  
20 Pcs



**AG8-2830**  
Mesh Cassettes  
5 Pieces, 7 Pieces, 10 Pieces,  
15 Pieces & 20 Pieces



**MESH TRAY**  
AG8-2831 240x130x50mm  
AG8-2832 240x130x60mm  
AG8-2833 240x250x50mm  
AG8-2834 240x250x60mm  
AG8-2835 480x250x50mm  
AG8-2836 480x250x60mm  
AG8-2837 480x250x70mm



**MESH TRAY**  
AG8-2838 240x250x 50mm  
AG8-2839 240x250x 60mm  
AG8-2840 240x250x 70mm  
AG8-2841 480x250x 50mm  
AG8-2842 480x250x 60mm  
AG8-2843 480x250x 70mm  
AG8-2844 480x250x100mm



**MESH TRAY**  
AG8-2845 240x250x50mm  
AG8-2846 240x250x60mm  
AG8-2847 240x250x70mm  
AG8-2848 280x250x50mm  
AG8-2849 280x250x60mm



**MESH TRAY**  
AG8-2850 280x250x 70mm  
AG8-2851 280x250x100mm  
AG8-2852 280x250x 50mm  
AG8-2853 280x280x 60mm  
AG8-2854 280x280x 70mm  
AG8-2855 300x280x 60mm

## HOLLOWARE INSTRUMENTS



**AG8-2856**  
18×7×3.5cm  
5 Instruments Cassette  
Detachable Lids  
+  
5 Instruments Cassette Hinged  
Lids with button Lock



**AG8-2857**  
29×18.5×3.5cm  
20 Instruments Cassette Hinged  
Lids with surgical kit fitting,  
button lock



**Instruments Cassette**  
**AG8-2858** 5 Pieces Cassette  
**AG8-2859** 7 Pieces Cassette  
**AG8-2860** 10 Pieces Cassette



**AG8-2861**  
18×11×3.5cm  
Extra large cassette for 6  
Instruments, with compartment  
for small parts hinged lids



**AG8-2862**  
29×18.5×3.5cm  
20 Instruments Cassette  
Detachable Lids  
+  
20 Instruments Cassette Hinged  
Lids with button Lock

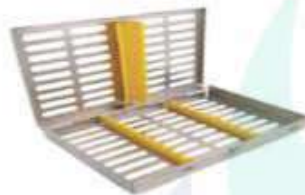

**AG8-2863**  
10×13×2.2cm  
10 Instruments Cassette Hinged  
Lids, Click Lock Available in 2  
designs



**AG8-2864**  
29×18.5×3.5cm  
20 Instruments Cassette Detachable  
Lids with elevator fitting  
+  
20 Instruments Cassette Hinged  
Lids with elevator fitting , button lock



**AG8-2865**  
18×9×2.2cm  
7 Instruments Cassette Hinged  
Lids, Click Lock, Available in 2  
designs



**AG8-2866**  
21×14×3.5cm  
15 Instruments cassette,  
Detachable lids, button lock



**AG8-2867**  
21×14×3.5cm  
15 Instruments cassette,  
detachable lids, button  
lock, with fitting of micro  
surgery kit



**AG8-2868**  
21×14×4.5cm  
8 pcs luxator/elevator  
cassette, Detach0  
able lids, button lock



**AG8-2869**  
15×9×5cm  
Box for dental implant tools and  
surgical kits, Capacity:8  
tools, 18 tools, 24 Tools, 58 Tools  
+ removable compartment



**Instruments Tray Perforated**  
**AG8-2870** 288 x 187 x 40 mm



**Instruments Tray Perforated Base**  
**AG8-2871** 288 x 187 x 40 mm



**Instruments Tray Solid Base**  
**AG8-2872** 288 x 187 x 40 mm

## DENTAL INSTRUMENTS SETS



**AG8-2873** Implant Basic Starter Kit 11 instruments with case



**AG8-2874** Crown Bridge Set Instruments with Case



**AG8-2875** Bone Curettes Spoon Style set of 4 with Metal Case



**AG8-2876** Peritome Set of 2 with Blue Nitrate Tips and Metal Case



**AG8-2877** Root Fragment Removal elevators, Set of 4 with Metal Case



**AG8-2878** Peritome Set of 3 Gold Handles Serrated Blades with Metal Case





| DESCRIPTION                                       | PAGE#       |
|---|-------------|
| <b>A</b>  |             |
| A COSMETIC CONTOURING IMPLANTOLOGY                | 148         |
| AB1 BOGHOSIAN IMPLANTOLOGY                        | 147         |
| AB2 BOGHOSIAN IMPLANTOLOGY                        | 147         |
| ABOU-RASS EXPLORERS                               | 54          |
| ACUTE IMPLANTOLOGY                                | 161         |
| ADAMS PUIER                                       | 133         |
| ADAMS PUIER ROUND BOX                             | 138         |
| ADAMS PLIERS FOR HOOKS AND BENDING                | 132         |
| ADAMS, SMALL WIRE BENDING AND LOOP FORMING PLIERS | 138         |
| ADERER CLAMP THREE JAW WIRE BENDING PUIER         | 134         |
| ADERER FACEBOW LOOP FORMING PLIERS                | 133         |
| ADERER LARGE WIRE BENDING AND LOOP FORMING PLIERS | 134         |
| ADERER PUIER                                      | 36,141      |
| ADHESIVE REMOVING PLIERS                          | 169         |
| ADSON 7X7 CURVED TISSUE FORCEPS                   | 53          |
| ADSON BROWN TWEEZERS                              | 169         |
| ADSON CARBIDE TIPPED TISSUE FORCEPS               | 107         |
| ADSON NEEDLE HOLDERS                              | 53          |
| ADSON-TC TWEEZERS                                 | 88          |
| ADULT PALATAL, DENTAL PHOTOGRAPHIC MIRRORS        | 110         |
| ALLIS HAEMOSTATIC FORCEPS                         | 110         |
| ALLIS-BABY HAEMOSTATIC FORCEPS                    | 109         |
| ALL-PURPOSE PLIERS                                | 127         |
| ALUMINIUM CALIPER                                 | 102         |
| ALM RETRACTOR                                     | 117         |
| AMALGAM CARRIERS                                  | 116,117     |
| AMALGAM WELLS                                     | 115,117     |
| ANATOMIC HANDLE EXPLORERS                         | 54          |
| ANDREWS FILLING INSTRUMENTS                       | 87          |
| ANGLE HOW PUIER                                   | 139         |
| ANGLED DIRECT BOND BRACKET REMOVER TC             | 3           |
| ANGLED EXTRACTING FORCEPS FOR UPPER ROOTS         | 138         |
| ANGLED UTILITY PLIERS                             | 111         |
| ANISWORTH RUBBER DAM CLAMPS FORCEPS               | 58          |
| ANTERIOR  | 96          |
| APEX FORCEPS LOWER ROOT DEEP ROOT PICK            | 5           |
| APEX FORCEPS LOWER UNIVERSAL DEEP ROOT PICK       | 29          |
| APEXO ROOT ELEVATORS                              | 31,33       |
| APICAL RETENTION FORCEPS                          | 38,143      |
| APICAL ROOT ELEVATORS                             | 139         |
| ARCH BENDING PLIERS                               | 97          |
| ARCHWAY CLASP FORMING PLIERS                      | 27          |
| ARTICULATORS                                      | 52          |
| ASPIRATING SYRING                                 | 52          |
| ATRAUMATIC TWEEZERS                               | 52          |
| ATRAUMATIC WITH LOCK TWEEZERS                     |             |
| <b>B</b>  |             |
| BABY TOOTH EXTRACTION FORCEPS SET OF 7 PIECES     | 88          |
| BACK ACTION FILLING INSTRUMENTS                   | 110         |
| BACKHAUS HAEMOSTATIC FORCEPS                      | 110         |
| BACKHAUS TOWEL CLAMPS                             | 96          |
| BACULITE HANDLE WAX KNIVES                        | 71          |
| BALL BURNISHERS                                   | 93          |
| BALL FILLING INSTRUMENTS                          | 110         |
| BALL SOCKET NOT-PERFORATING AND NOT-DAMAGING      | 88          |
| BALLACORN FILLING INSTRUMENTS                     | 32,138      |
| BAND REMOVING PLIERS                              | 129         |
| BAND SEATER AUTO CLEAVABLE                        | 129         |
| BAND SEATER AUTO CLEAVABLE ROUND SHAPE            | 129         |
| BAND SEATER AUTO CLEAVABLE SQUARE SHAPE           | 129         |
| BAND SEATER AUTO CLEAVABLE TRIANGLE SHAPE         | 129         |
| BAND SEATING & REMOVING INSTRUMENTS               | 129         |
| BAND SEATING & REMOVING SILICON GRIP              | 141         |
| BAND SEATING PLIERS                               | 134         |
| BANDS & CROWNS PUIER                              | 109         |
| BARRAQUER T.C NEEDLE HOLDERS                      | 174         |
| BASINS FOR BONE                                   | 96,107      |
| BAUMGARTNER NEEDLE HOLDERS                        | 36          |
| BAYONET ROOTS ELEVATOR SET                        | 88          |
| BEAVERTAIL FILLING INSTRUMENTS                    | 106         |
| BEEBEE GUM SCISSORS                               | 127         |
| BEERENDONK CALIPER                                | 29,40       |
| BEIN ROOT ELEVATORS                               | 136         |
| BENDING PUIER                                     | 72          |
| BESEK COMPOSITE INSTRUMENTS                       | 82          |
| BESEK COMPOSITE MODELLING INSTRUMENTS             | 82          |
| BESEK COMPOSITE PLUGGERS INSTRUMENTS              | 82          |
| BESEK PLUGGERS                                    | 78          |
| BEYER BONE ROUINER                                | 25          |
| BIRANGLE SCALER                                   | 57          |
| BIRD BEAK PUIER                                   | 38,141      |
| BIRD BEAK PUIER FOR BENDING                       | 133         |
| BIRD BEAK PUIER STANDARD                          | 134         |
| BIRD BEAK WIRE BENDING & CUTTING PLIERS           | 133         |
| BIRD BEAK WIRE BENDING PUIER                      | 101         |
| BISHOP RETRACTORS                                 | 80,87       |
| BLACK FILLING INSTRUMENTS                         | 66          |
| BLACK SCALER                                      | 147,148,149 |
| BLACK TITANIUM COLOUR COATED INSTRUMENTS          | 166         |
| BLADE AND PUSHER                                  | 59,187      |
| BLUE TITANIUM COATED BONE GRAFTING INSTRUMENTS    | 159         |
| SET OF 7 PCS WITH CASSETTE                        | 25          |
| BLUMENTHAL BONE ROUINER                           | 127         |
| BOLEY GAUGE                                       | 125         |
| BONE BRACKET GAUGE                                | 165         |
| BONE CARRIER TITANIUM                             | 174         |
| BONE CRUSHER                                      | 174         |
| BONE CRUSHER TITANIUM METAL CUTTER                | 178         |
| BONE EXPANDER KIT                                 | 178         |
| BONE EXPANDER SCREW & SURGICAL KITS               | 119         |
| BONE FILES  | 159         |
| BONE GRAFT  | 156         |
| BONE GRAFT IMPLANTOLOGY                           | 164         |
| BONE GRAFT PACKER                                 | 167         |
| BONE GRAFT/CARRIER TITANIUM                       | 166         |
| BONE GRAFTING INSTRUMENTS COMPACTOR /TAMPERS      | 175         |
| BONE INJECTORS, COLLECTORS & SUCTION TUBE         | 174         |
| BONE MILL   | 25          |
| BONE ROUINER                                      | 173         |
| BONE SCRAPER                                      | 173         |
| BONE SCRAPER STRAIGHT & CURVED                    | 168         |
| BONE SPOON PACKER                                 |             |

| DESCRIPTION   | PAGE#       |
|---|-------------|
| BONE THICKNESS GAUGE                                  | 146         |
| BONE UNIVERSAL KIT                                    | 176         |
| BONE WELL   | 174         |
| BOX FOR DENTAL IMPLANT TOOLS AND SURGICAL KITS        | 132,133,134 |
| BOX JOINT PLIERS                                      | 128         |
| BRACKET HOLDER TWEEZERS                               | 128         |
| BRACKET PLACER TWEEZERS                               | 128         |
| BRACKET PLACING TWEEZES                               | 132         |
| BRACKET REMOVING PUIER CURVED                         | 132         |
| BRACKET REMOVING PUIER ROUND BOX                      | 136         |
| BRACKET REMOVING PLIERS ANGLED                        | 136         |
| BRACKET REMOVING PLIERS STRAIGHT                      | 136         |
| BRACKET REMOVING PLIERS WITH PLASTIC TIP              | 128         |
| BRACKET TWEEZERS SLOT ALIGNER                         | 111         |
| BREWER RUBBER DAM CLAMPS FORCEPS                      | 101         |
| BRIENINGS RETRACTORS                                  | 61          |
| BUCCAL AND LINGUAL/PALATAL SCALER                     | 98          |
| BUCCAL DENTAL PHOTOGRAPHIC MIRRORS                    | 61          |
| BUCCAL SURFACES SCALER                                | 96          |
| BUCCAL SMALL DENTAL PHOTOGRAPHIC MIRRORS              | 78,88       |
| BURNISHER FILLING INSTRUMENTS                         | 149         |
| BURNISHERS  | 68,71       |
| BURNISHERS CONSERVATIVE TREATMENT                     | 121         |
| BUSER PERIODONTAL INSTRUMENTS                         |             |
| <b>C</b>  |             |
| COSMETIC CONTOURING IMPLANTOLOGY                      | 148         |
| CARBIDE DIAMOND COATED POINT                          | 24          |
| CARRY FORCEPS   | 170         |
| CARVER COMPOSITE MODELLING INSTRUMENTS                | 85          |
| CARVERS INSTRUMENTS                                   | 88,90       |
| CARVERS INSTRUMENTS CASSETTE FOR 5 INSTRUMENTS        | 90          |
| CASSETTE FOR INSTRUMENTS                              | 102         |
| CASTROVEJO CALIPERS                                   | 126         |
| CASTROVEJO GUM SCISSORS                               | 105         |
| CASTROVEJO MICRO SCISSORS                             | 108         |
| CASTROVEJO NEEDLE HOLDERS                             | 107,109     |
| CATHETERS TRAY WITH LID BOX WITH FILTER               | 184         |
| CATRIDGE SYRING                                       | 27          |
| CEMENT SPATULAS                                       | 95          |
| CERI SAW  | 124         |
| CHEEK RETAINER  | 101         |
| CHILD PALATAL DENTAL PHOTOGRAPHIC MIRRORS             | 96          |
| CHIP BLOWER   | 116         |
| CHISELS, SCONE FILES & SPOONE CURETTE                 | 118         |
| CHISELS SCALER  | 65,67       |
| CHOMPRET ROOT ELEVATOR                                | 42          |
| CINCH BACK / TIE BACK DISTAL END BENDING PLIERS       | 137         |
| CLAW-LIFT ROOTS ELEVATOR                              | 37          |
| COARSE SUCTION TUBES                                  | 178         |
| COBRA IMPLANTOLOGY                                    | 196         |
| COHEN UNIVERSAL EXTRACTING FORCEPS (AMERICAN PATTERN) | 17          |
| COLLEGE FORCEPS                                       | 51          |
| COLLEGE TWEEZER                                       | 53          |
| COLLEGE WITH LOCK TWEEZERS                            | 52          |
| COLLINS TONGUE FORCEPS                                | 110         |
| COLUMBIA RETRACTOR                                    | 99          |
| COMBINATION RETRACTORS                                | 101         |
| COMELLAS FORCEPS ANATOMICAL HANDLE                    | 26          |
| COMPASSO DE WILLIS                                    | 127         |
| COMPOSITE BALL PLUGGERS                               | 76          |
| COMPOSITE FILLING INSTRUMENTS                         | 82,93       |
| COMPOSITE FILLING INSTRUMENTS SET OF 6 PCS            | 63          |
| COMPOSITE GOLD TIP INSTRUMENTS                        | 72,73       |
| COMPOSITE INSTRUMENTS                                 | 89          |
| COMPOSITE INSTRUMENTS BLUE TITANIUM WITH CASSETTES    | 89          |
| COMPOSITE INSTRUMENTS TITANIUM BLUE ENDODONTIC        | 85          |
| COMPOSITE MODELLING INSTRUMENTS                       | 82,83       |
| COMPOSITE PLUGGERS INSTRUMENTS                        | 87          |
| COMPOSITE/PLASTIC FILLING INSTRUMENTS                 | 150,161     |
| CONDENSER IMPLANTOLOGY                                | 49          |
| CONE-SOCKET MOUTH MIRRORS                             | 49          |
| CONE-SOCKET FRONT SURFACE MOUTH MIRRORS               | 50          |
| CONE-SOCKET MIRROR HANDLES FOR MOUTH MIRRORS          | 49          |
| CONE-SOCKET PLAN MOUTH MIRRORS                        | 49          |
| CONE-SOCKET RHODIUM MOUTH MIRRORS                     | 50          |
| CONE-SOCKET SOLID HANDLES FOR MOUTH MIRRORS           | 50          |
| CONE-SOCKET SOLID OCTAGONAL HANDLES FOR MOUTH MIRRORS | 134,138     |
| CONTOURING PLIERS                                     | 161         |
| COPRACHO HOLLOWARE INSTRUMENTS                        | 145         |
| CORROSION-RESISTANT                                   | 196         |
| COTTON HOLDER   | 196         |
| COTTON HOLDING JAR                                    | 196         |
| COTTON WOOL DISPENSER ACC. TO METHOF                  | 34          |
| COUPLAND ROOT ELEVATORS                               | 53          |
| CRANE KAPLAN TWEEZERS                                 | 105,107     |
| CRILE-WOOD NEEDLE HOLDERS                             | 114         |
| CROWN REMOVER   | 114         |
| CROWN SPREADERS                                       | 124         |
| CRUCIBLE TONGS  | 12,13,19,20 |
| CRYER EXTRACTING FORCEPS (AMERICAN PATTERN)           | 32          |
| CRYER ROOT ELEVATORS                                  | 139,142     |
| CUTTER  | 141         |
| CUTTER, UTILITY PLIERS & WIRE FORMING PLIERS          |             |
| <b>D</b>  |             |
| DEAN GUM SCISSORS                                     | 105         |
| DEBARKY ATRAUMATIC TISSUE FORCEPS                     | 169         |
| DELUX BOLEY GAUGE                                     | 127         |
| DELUXE BRACKET HOLDER                                 | 128         |
| DELUXE BRACKET HOLDER TWEEZERS                        | 100         |
| DENHARD RETRACTORS - MOUTH GAGS                       | 98          |
| DENTAL PHOTOGRAPHIC MIRRORS                           | 27          |
| DENTAL SYRINGES                                       | 127         |
| DENTAURUM CALIPER                                     | 106,107     |
| DERF NEEDLE HOLDERS                                   | 139         |
| DETAILING STEP PUIER                                  | 137         |
| DETAILING STEP PLIERS / BAYONET BENDING PLIERS        | 65          |
| DIAMOND COATED MARGIN TRIMMERS                        | 128         |
| DIRECT BOND BRACKET HOLDER TWEEZERS                   | 128         |
| DIRECT BOND BRACKET HOLDER TWEEZERS, SMALL TIP        | 128         |
| DIRECT BONDING BRACKET HOLDERS                        | 149         |
| DIRECT BRACKET REMOVER TC                             | 27          |
| DISC SYSTEM DENTAL SYRINGES                           | 94          |
| DISSECTING SET SET OF 11 PCS                          | 94          |
| DISSECTING SET SET OF 9 PCS                           |             |



# INDEX

| DESCRIPTION   | PAGE#                |
|---|----------------------|
| DISTAL AMAL GAM CARRIERS  | 117                  |
| DISTAL BENDER SILICON GRIP  | 129                  |
| DISTAL CUTTER   | 139                  |
| DISTAL END CUTTER   | 135                  |
| DISTAL END CUTTER FLUSH CUT   | 142                  |
| DISTAL END CUTTER, SAFETY HOLD PLIER (IDEAL FOR CUTTING WIRE) TC          | 140                  |
| DISTAL END WIRE CUTTERS & BRACKET REMOVER PLIERS                          | 140                  |
| DISTAL SCALERS  | 61,63                |
| DOUBLE ENDED CEMENT SPATULA   | 131                  |
| DOUBLE ROUNDED JAW BENDING PLIERS   | 138                  |
| DOUBLE ENDED EXPLORERS  | 54                   |
| DRESSING TWEEZERS   | 52,53                |
| DYNAMOMETER   | 146                  |
| <b>E</b>  |                      |
| EASY ACCESS TWEEZES   | 128                  |
| EBNETER SCALER  | 64                   |
| ELASTIC INSTRUMENT SILICON GRIP   | 129                  |
| ELASTIC SEPARATING PLIER  | 140                  |
| ELASTIC SEPARATING PLIER ROUND HANDLE                                     | 140                  |
| ELASTOMERIC LIGATURE PLACING FORCEPS WITH GROOVE FALCON                   | 140                  |
| ELEVATORS SET OF 8 PCS  | 46                   |
| ELEVATORS SET OF 8 PCS  | 46                   |
| ELLIOTT SIGVELAND RETAINERS   | 115                  |
| ENDO FINGER RULER SPAN MEASURE SCALE                                      | 125                  |
| ENDODONTIC BOX  | 186                  |
| ENDODONTIC EXPLORER   | 154                  |
| ENDODONTICS INSTRUMENTS   | 58                   |
| ERGO GRIP RETRACTOR   | 101                  |
| EURO-BREXCH LOADING DENTAL SYRINGES                                       | 27                   |
| EXAMINATORS EXPLORERS   | 51                   |
| EXCAVATOR INSTRUMENTS   | 74                   |
| EXCAVATORS  | 86                   |
| EXECT BRACKET HOLDER TWEEZERS   | 128                  |
| EXPLORERS   | 51,54,55,56          |
| EXTRACTING FORCEPS (AMERICAN PATTERN)                                     | 126,24               |
| EXTRACTING FORCEPS (ENGLISH PATTERN)                                      | 01to07,26            |
| EXTRACTING FORCEPS (ENGLISH PATTERN) SET OF 10 PIECES                     | 07                   |
| EXTRACTING FORCEPS  | 08                   |
| EXTRACTING FORCEPS AMERICAN ADULT SET OF 10 PCS                           | 28                   |
| EXTRACTING FORCEPS AMERICAN ADULT SET OF 8 PCS                            | 28                   |
| EXTRACTING FORCEPS CHILDREN PATERN SET OF 10 PIECES                       | 28                   |
| EXTRACTING FORCEPS ENGLISH ADULT SET OF 10 PCS                            | 28                   |
| EXTRACTING FORCEPS ENGLISH ADULT SET OF 8 PCS                             | 28                   |
| EXTRACTING FORCEPS PEDO SET OF 7 PCS                                      | 28                   |
| EXTRACTING FORCEPS SET  | 28                   |
| EXTRACTING FORCEPS SET OF 10 PIECES                                       | 28                   |
| EXTRACTING FORCEPS SET OF 10 PIECES                                       | 28                   |
| EXTRACTING FORCEPS SET OF 13 PIECES                                       | 28                   |
| EXTRA-FLEX IMPLANTOLOGY   | 147                  |
| <b>F</b>  |                      |
| FALCON BEAK CONTOURING PLIERS   | 133,138              |
| FARABEUF RETRACTORS SET OF 2 PCS  | 103                  |
| FELDMAN RETRACTOR   | 103                  |
| FILLING INSTRUMENTS (GOLD POINTED)  | 91                   |
| FILLING INSTRUMENTS   | 87,88,91,93          |
| FILLING INSTRUMENTS CONSERVATIVE TREATMENT                                | 89,70,75,76,79,81,84 |
| FIRST AID EXAMINATION SET OF 3 PIECES                                     | 51                   |
| FLEXIBLE PERITOME   | 163                  |
| FLEXI-TURN IMPLANTOLOGY   | 147                  |
| FLOHR ROOT ELEVATORS  | 29,33                |
| FLUSH-CUT DISTAL AND CUTTING PLIERS                                       | 113                  |
| FLUSH-CUT DISTAL END CUTTER   | 135                  |
| FOERSTER DRESSING FORCEPS   | 110                  |
| FRAZIER SUCTION TUBES WITH FILTER   | 178                  |
| FREEDMAN 'DUCKHEAD'   | 149                  |
| FREEDMAN BURNISHERS   | 149                  |
| FREEDMAN LARGE CONTACT FORMING  | 149                  |
| FREEDMAN SMALL CONTACT FORMING  | 149                  |
| FREER PERIODONTAL INSTRUMENTS   | 121                  |
| FREER PERIOSTEEL ELEVATORS  | 120                  |
| FRET SAW  | 124                  |
| FRIEDMAN BONE ROUNDER   | 25                   |
| FRIEDMANN ROOT ELEVATOR   | 36                   |
| FRIEDMANNRICHARD PERIODONTAL INSTRUMENTS                                  | 122                  |
| FUZZI COMPOSITE MODELLING INSTRUMENTS                                     | 85                   |
| <b>G</b>  |                      |
| GERALD TWEEZERS   | 52                   |
| GILLES TWEEZERS   | 52                   |
| GILLES NEEDLE HOLDER WITH SCISSORS  | 107                  |
| GLOVES BOX  | 184                  |
| GOLD COLOR SET DENTAL ORAL IMPLANTOLOGY SINUS SET OF 10 PCS WITH CASSETTE | 156                  |
| GOLD MILL (LARGE)   | 174                  |
| GOLD MILL (SMALL)   | 174                  |
| GOLDMAN FOX SUPER CUT SCISSORS  | 108                  |
| GOLDMAN FOX EXPLORERS   | 55                   |
| GOLDMAN FOX SCISSORS  | 108                  |
| GOLDMAN-FOX GUM SCISSORS  | 104,105              |
| GOLDMAN-FOX PERIODONTAL INSTRUMENTS                                       | 121                  |
| GOLDMANN-FOX SCALER   | 64                   |
| GRACEY AFTER FIVE   | 61                   |
| GRACEY CURETTES SCALER  | 61                   |
| GRACEY CURETTES   | 59,63                |
| GRACEY MINI FIVE  | 61                   |
| GRACEY SCALER   | 61                   |
| GRAFT MATERIAL SPOON CONCAVE TIP FOR LARGER GRAFTS                        | 165                  |
| GRAFT PACKER  | 166                  |
| GRAFT PACKER, CONCAVE   | 168                  |
| GRIPPER CARBIDE TIPPED TISSUE FORCEPS TC                                  | 189                  |
| GRITMAN CEMENT SPATULAS   | 95                   |
| GROSS MAIER DRESSING FORCEPS  | 110                  |
| GULDENER SCALER   | 64                   |
| GUM SCISSORS  | 104to108             |
| <b>H</b>  |                      |
| HAEMOSTATIC FORCEPS & TOWEL CLAMPS  | 110                  |
| HALSEY NEEDLE HOLDERS   | 106,107              |
| HALSTEAD MOSQUITO HAEMOSTATIC FORCEPS                                     | 110                  |
| HALSTEAD MOSQUITO NEEDLE HOLDERS  | 107                  |
| HALTEPNETZETTE WITH LOCK TWEEZERS   | 170                  |

| DESCRIPTION   | PAGE#                   |
|---|-------------------------|
| HAMMER HEAD DISTAL END BENDING PLIERS                 | 137                     |
| HAMMER WITH WOODEN HANDLE                             | 124                     |
| HANDLE ROUND HANDLES FOR MOUTH MIRRORS                | 50                      |
| HANDLES FOR MOUTH MIRRORS                             | 50                      |
| HARD WIRE CUTTER                                      | 142                     |
| HARD WIRE CUTTER STRAIGHT                             | 142                     |
| HARD WIRE CUTTER, 15° ANGLED                          | 135                     |
| HARD WIRE CUTTER, 15° ANGLED NON-AUTOCALAWABLE        | 135                     |
| HARD WIRE CUTTER, STRAIGHT                            | 142                     |
| HARD WIRE CUTTERS                                     | 142                     |
| HARRIS EXTRACTING FORCEPS (AMERICAN PATTERN)          | 13,18                   |
| HARTMANN (BABY MOSQUITO) NEEDLE HOLDERS               | 107                     |
| HEAT CARRIERS   | 57                      |
| HEBER BAYONET ROOTS ELEVATOR                          | 40                      |
| HEBER ROOTS ELEVATOR                                  | 40                      |
| HEEDBRINK ROOT APPEX ELEVATOR                         | 44                      |
| HEEDBRINK ROOT ELEVATORS                              | 33,43                   |
| HEEDBRINK ROOTS ELEVATOR WARWICK-JAMES                | 44                      |
| HEIDEMANN FILLING INSTRUMENTS                         | 93                      |
| HEIDEMANN SPATULAS                                    | 73                      |
| HEIGHT GAUGE 0.18 STAINLESS STEEL                     | 125                     |
| HEIGHT GAUGE ALUMINUM                                 | 125                     |
| HEMINGWAY TWEEZERS                                    | 53                      |
| HEX TORQUE WRENCH UNIVERSAL                           | 177                     |
| HEXAGONAL HANDLES FOR MOUTH MIRRORS                   | 50                      |
| HIRS FELD PERIODONTAL INSTRUMENTS                     | 122                     |
| HRT COMPOSITE MODELLING INSTRUMENTS                   | 85                      |
| HRT COMPOSITE PLUGGERS INSTRUMENTS                    | 83                      |
| HRT SCALER  | 66                      |
| HMG HEISTER   | 99                      |
| HOLLENBACK FILLING INSTRUMENTS                        | 88,87                   |
| HOLLOW CHOP CONTOURING PLIERS                         | 143                     |
| HOLLOW HANDLES FOR MOUTH MIRRORS                      | 50                      |
| HOLLOW MIRROR HANDLES FOR MOUTH MIRRORS               | 50                      |
| HOLLOWWARE INSTRUMENTS                                | 183,184,186,187,190,191 |
| HOLZ SCALER   | 85                      |
| HOOK CRAMPING PLIER ANGLED STRAIGHT TC                | 140                     |
| HOOK KNIVES   | 96                      |
| HOPSON FILLING INSTRUMENTS                            | 78                      |
| HOW PLIER   | 132                     |
| HOW PLIER CURVED                                      | 132                     |
| HOW PLIERS OFFSET                                     | 141                     |
| HOW PLIERS STRAIGHT                                   | 136                     |
| HOW STRAIGHT UTILITY PLIERS                           | 130                     |
| HOWARD PERIOSTEEL ELEVATORS                           | 130                     |
| HULL EXTRACTING FORCEPS (AMERICAN PATTERN)            | 15                      |
| HYLIN CEMENT SPATULAS                                 | 95                      |
| HYLIN ROOTS ELEVATOR                                  | 39                      |
| <b>I</b>  |                         |
| IMPLANT GAGES   | 145                     |
| IMPLANT SINUS LIFT INSTRUMENTS                        | 161,162                 |
| IMPLANTOLOGY  | 145to178                |
| IMPLANTOLOGY 9 PCS OF SET                             | 161                     |
| IMPLANTOLOGY SET OF 2 COMPOSITE BLUE TIP INSTRUMENTS  | 154                     |
| IMPLANTOLOGY SET OF 3 COMPOSITE BLUE TIP INSTRUMENTS  | 154                     |
| IMPLANTOLOGY SET OF 4 COMPOSITE BLUE TIP INSTRUMENTS  | 154                     |
| IMPLANTOLOGY SET OF 5 COMPOSITE GOLD TIP INSTRUMENTS  | 154                     |
| IMPRESSION TRAYS                                      | 179to182                |
| IMPRESSION TRAYS PERFORATED FULL DENTURE SET OF 8 PCS | 181                     |
| IMPRESSION TRAYS PERFORATED WITHOUT RIM LOCK          | 182                     |
| IMPRESSION TRAYS SOLID FULL DENTURE SET OF 06 PCS     | 181                     |
| IMPRESSION TRAYS SOLID FULL DENTURE SET OF 8 PCS      | 181                     |
| IMPRESSION TRAYS SOLID WITH RIM LOCK                  | 182                     |
| IMPRESSION TRAYS SOLID WITH RIM LOCK SET OF 06 PCS    | 180                     |
| IMPRESSION TRAYS SOLID WITH RIM LOCK SET OF 08 PCS    | 180                     |
| IMPRESSION TRAYS SOLID WITH RIM LOCK SET OF 10 PCS    | 180                     |
| INSTRUMENTS BOX                                       | 184                     |
| INSTRUMENTS BOX PERFORATED                            | 184                     |
| INSTRUMENTS BOX WITH HOOKS                            | 184                     |
| INSTRUMENTS BOX WITH LID                              | 184                     |
| INSTRUMENTS CASSETTE 10 HINGED                        | 191                     |
| INSTRUMENTS CASSETTE 10 PIECES CASSETTE               | 191                     |
| INSTRUMENTS CASSETTE 16 SURGERY KIT                   | 191                     |
| INSTRUMENTS CASSETTE                                  | 191                     |
| INSTRUMENTS CASSETTE 20 DETACHABLE                    | 191                     |
| INSTRUMENTS CASSETTE 20 DETACHABLE LIDS               | 191                     |
| INSTRUMENTS CASSETTE 20 HINGED                        | 191                     |
| INSTRUMENTS CASSETTE 5 DETACHABLE LIDS                | 191                     |
| INSTRUMENTS CASSETTE 5 HINGED LIDS WITH BUTTON LOCK   | 191                     |
| INSTRUMENTS CASSETTE 6 PIECES CASSETTE                | 191                     |
| INSTRUMENTS CASSETTE 7 HINGED                         | 191                     |
| INSTRUMENTS CASSETTE 7 PIECES CASSETTE                | 191                     |
| INSTRUMENTS TRAY PERFORATED                           | 183,191                 |
| INSTRUMENTS TRAY PERFORATED BASE                      | 191                     |
| INSTRUMENTS TRAY SOLID BASE                           | 191                     |
| INSTRUMENTS TRAYS                                     | 183                     |
| INSTRUMENTS TRAYS WITH COVER                          | 184                     |
| INSTRUMENTS TRAYS WITH LID                            | 183                     |
| INSTRUMENTS TRAYS WITHOUT COVER                       | 184                     |
| INTRALIGAMENTAL ANESTHESIA SYRINGE                    | 27                      |
| IRIS GUM SCISSORS                                     | 104                     |
| IRIS SUPER CUT SCISSORS                               | 108                     |
| IRIS GUM SCISSORS                                     | 104,105,108             |
| IVORY SIGVELAND RETAINERS                             | 115                     |
| IVORY LIGHT WEIGHT RUBBER DAM CLAMPS FORCEPS          | 111                     |
| IVORY MATRIX RETAINERS                                | 115                     |
| IVORY RETRACTORS                                      | 111                     |
| IVORY RUBBER DAM CLAMPS FORCEPS                       | 111                     |
| IMANSON SPRING CALIPER FOR METAL AND PORCELAIN        | 126                     |
| IMANSON SPRING CALIPER FOR WAX                        | 126                     |
| <b>J</b>  |                         |
| JACQUETTE SCALER                                      | 63                      |
| JARABAK PLIERS  | 143                     |
| JECT ULTIMA DENTAL SYRINGES                           | 27                      |
| JENNINGS RETRACTORS - MOUTH GAIGS                     | 100                     |
| JOHNSON CONTOURING PLIERS                             | 133                     |
| JOHNSON PLIERS FOR CROWN BAND CONTOURING              | 138                     |
| JONES TOWEL CLAMPS                                    | 110                     |
| JOSEPH GUM SCISSORS                                   | 105                     |
| <b>K</b>  |                         |
| KALT NEEDLE HOLDERS TC                                | 109                     |
| KELLS EXTRACTING FORCEPS (AMERICAN PATTERN)           | 15                      |



| DESCRIPTION  | PAGE#   |
|--|---------|
| KELLY GUM SCISSORS   | 104,105 |
| KELLY HAEMOSTATIC FORCEPS  | 110     |
| KELLY-RANKIN HAEMOSTATIC FORCEPS                                   | 110     |
| KEY RINGS  | 94      |
| KEYS FOR IMPLANT SCREW   | 177     |
| KILNER (RAGNELL) GUM SCISSORS                                      | 105     |
| KIRKLAND SCALER  | 54      |
| KLEIN EXTRACTING FORCEPS   | 88      |
| KLEINERT-KUTZ BONE ROUNDER   | 25      |
| KOPF ROOTS ELEVATOR  | 39      |
| KRAMER NEVINS SINUS LIFT   | 162     |
| KRAMER NEVINS PERIODONTAL INSTRUMENTS                              | 121     |
| KRAMER-NEVINS BONE CHISEL  | 119     |
| KUEHNE TWEEZERS  | 170     |
| <b>L</b>   |         |
| LA GRANGE NEEDLE HOLDERS   | 109     |
| LA GRANGE GUM SCISSORS   | 104,105 |
| LADMORE FILLING INSTRUMENTS  | 88      |
| LADMORE IMPLANTOLOGY   | 149     |
| LAGRANGE SCISSORS  | 108     |
| LAGRANGE SUPER CUT SCISSORS  | 108     |
| LANGENBECK RETRACTORS  | 103     |
| LANGER SCALER  | 63      |
| LAP & L-KEY JOINT PLIERS   | 139     |
| LARGE FLUCH-CUT DISTAL AND CUTTING PLIERS                          | 133     |
| LAXUTOR ROOT ELEVATORS   | 39, 31  |
| LAXUTOR ROOT ELEVATORS SET OF 9 PCS                                | 38      |
| LE CRON CEMENT SPATULAS  | 95      |
| LECLUSE BAYONET ROOT ELEVATOR                                      | 41      |
| LESSMANN WAX KNIVES  | 96      |
| LICHTENBERG-RYDER TC NEEDLE HOLDERS                                | 109     |
| LIGATURE FORMING PLIERS  | 134     |
| LIGATURE INSTRUMENT SILICON GRIP                                   | 129     |
| LIGHT WORE BIRD BEAK PLIERS WITH GROOVE                            | 143     |
| LINDO-LEVIAN ROOT ELEVATORS  | 35      |
| LINGUAL / PALATAL ARCH FORMING PLIERS                              | 134     |
| LINGUAL ARCH FORMING PLIERS  | 143     |
| LINGUAL DENTAL PHOTOGRAPHIC MIRRORS                                | 98      |
| LINGUAL-PALATAL SURFACES SCALER                                    | 61      |
| LINGUAL-LARGE DENTAL PHOTOGRAPHIC MIRRORS                          | 98      |
| LIP & CHEEK RETRACTOR  | 100     |
| L-KEY JOINT PLIERS   | 139,138 |
| LOCKLIN GUM SCISSORS   | 105     |
| LONDON COLLEGE TWEEZERS  | 52      |
| LONDON HOSPITAL  | 34      |
| LONG IMPLANT DRILLS  | 176     |
| LOOP FORMING IN FOUR LENGTH  | 138     |
| LORNHAEMOSTATIC FORCEPS  | 110     |
| LUCAS IMPLANTOLOGY   | 168     |
| LUER BONE ROUNDER  | 25      |
| LUXS   | 58      |
| LUXATING ELEVATOR / PERIOTOME                                      | 36      |
| LUXATING ELEVATOR WITH PERIOTOME TIP                               | 36      |
| LUXATOR ROOT ELEVATORS   | 29      |
| LUXATOR/ELEVATOR 5 PCS   | 191     |
| LUXATORS SET OF 7 PCS  | 46      |
| LUXATORS SET OF 7 PCS  | 46      |
| LUXATORS SET OF 8 PCS  | 46      |
| LUXATOR ROOTS ELEVATOR   | 40      |
| LUXATORS CURVED ATRAUMATIC LUXATION OF THE TOOTH                   | 48      |
| LUXATORS STRAIGHT ATRAUMATIC LUXATION OF THE TOOTH                 | 48      |
| <b>M</b>   |         |
| MAGNIFYING MOUTH MIRRORS   | 49      |
| MALLET IMPLANTOLOGY  | 174     |
| MALLETS - PLASTER SHEARS - SAWS & BLADES                           | 124     |
| MANUAL ASPIRATING SYRINGE  | 27      |
| MANUAL CROWN REMOVERS  | 114     |
| MARGIN TRIMMERS  | 86      |
| MARGINAL RIDGE & EMBRASURE SHAPING INSTRUMENT                      | 148     |
| MARKLEY FILLING INSTRUMENTS  | 93      |
| MARQUETTE CONDENSER  | 87      |
| MARQUETTE PLUGGERS   | 87      |
| MARYAM TWEEZERS  | 53      |
| MATHEU NEEDLE HOLDERS  | 107     |
| MATRIX RETAINERS   | 116     |
| MAXI HULL-DWARRE INSTRUMENTS                                       | 197     |
| MAYO GUM SCISSORS  | 106     |
| MAYO NEEDLE HOLDERS  | 106     |
| MAYO TRAY PERFORATED   | 183     |
| MAYO-HEGAR NEEDLE HOLDERS  | 106,107 |
| MCCALL SCALER  | 63      |
| MEAD BONE ROUNDER  | 25      |
| MEAD NON-AUTO CLAVABLE PLASTIC TIPS                                | 119     |
| MEASURING LOOP   | 128     |
| MEASURING LOOP, CASTROVIEJO  | 128     |
| MEASURING PROBE  | 145     |
| MEISSNER EXTRACTING FORCEPS  | 26      |
| MEMBRANE IMPLANTOLOGY  | 161     |
| MEMBRANE POSITIONING IMPLANTOLOGY                                  | 150     |
| MEMBRANE DETACH ELEVATOR   | 164     |
| MEMBRANE ELEVATOR  | 164     |
| MEMBRANE TWEEZERS  | 170     |
| MERRIAM TWEEZERS   | 52      |
| MERRIT 6 EXPLORERS   | 55      |
| MERTSON BAND PUSHER  | 129     |
| MESH CASSETTES 5 PIECES, 7 PIECES, 10 PIECES, 15PIECES & 20 PIECES | 190     |
| MESH TRAY  | 190     |
| MESH TRAYS 05 PCS  | 190     |
| MESH TRAYS 07 PCS  | 190     |
| MESH TRAYS 10 PCS  | 190     |
| MESH TRAYS   | 190     |
| MESH TRAYS 20 PCS  | 190     |
| MESIAL SCALER  | 61      |
| METZENBAUM GUM SCISSORS  | 104,108 |
| MICRO ADSON 1X2 TISSUE FORCEPS                                     | 169     |
| MICRO BOLEY GAUGE STRAIGHT   | 146     |
| MICRO BOLEY GAUGE TWISTED  | 146     |
| MICRO IRIS GUM SCISSORS  | 104     |
| MICRO SURGICAL SCALPEL HANDLE TITANIUM                             | 123     |
| MICRO-FRIEDMAN BONE ROUNDER  | 25      |
| MICRO-MINI PIN & LIGATURE CUTTER                                   | 142     |
| MIDDELSCHIFF RETRACTORS  | 103     |
| MILLER BONE FILES  | 119     |
| MILLER ROOT ELEVATORS  | 37      |

| DESCRIPTION   | PAGE#   |
|---|---------|
| MILLER IMPLANTOLOGY                                     | 168     |
| MILLER ROOT PLANNING FILES                              | 119     |
| MILLER TWEEZERS   | 53      |
| MINI DISTAL AMALGAM CARRIERS                            | 117     |
| MINI GAUGE  | 127     |
| MINI LIGATURE CUTTERS                                   | 133     |
| MINI PIN & LIGATURE CUTTER                              | 142     |
| MINI PIN & LIGATURE CUTTER TC                           | 139     |
| MINI-LANGENBECK RETRACTORS                              | 102     |
| MINI-SPATEL BURNISHERS                                  | 71      |
| MINNESOTA RETRACTORS                                    | 101     |
| MIRROR EXPLORERS  | 51      |
| MIRROR HANDLE STEM WITH RULE HANDLES FOR MOUTH MIRRORS  | 50      |
| MISCELLANEOUS PRODUCTS                                  | 94      |
| MIXING SPATULA WITH SHOVEL                              | 165     |
| MOLT 9 PERIODONTAL INSTRUMENTS                          | 121     |
| MOLT AUTO CLAVABLE PLASTIC TIPS                         | 119     |
| MONARI COMPOSITE MODELLING INSTRUMENTS                  | 85      |
| MORTENSON FILLING INSTRUMENTS                           | 89,87   |
| MOUTH MIRROR EXPLORERS                                  | 51      |
| MOUTH MIRRORS   | 49      |
| MOUTH PROPS   | 94      |
| MOVEABLE HEIGHT GAUGE                                   | 125     |
| MSY CEMENT SPATULAS                                     | 95      |
| MUEHLEMANN SCALER                                       | 64,65   |
| MULTIFUNCTIONAL METER                                   | 145     |
| MULTI-PURPOSE PLIERS                                    | 137     |
| <b>N</b>  |         |
| NAKAWALNI DENTAL LABORATORY INSTRUMENT                  | 57      |
| NANCE LOOP FORMING PLIERS                               | 132,137 |
| NAPKIN HOLDER WITH METAL CHAIN                          | 94      |
| NAPKIN HOLDER WITH PLASTIC CHAIN                        | 94      |
| NARROW SQUELLEND RETAINERS                              | 115     |
| NEEDLE HOLDERS  | 108,109 |
| NEEDLE STERILIZATION TUB                                | 186     |
| NEUMANN GUM SCISSORS                                    | 105     |
| NEVINS EXTRACTING FORCEPS (AMERICAN PATTERN)            | 14,16   |
| NORMAL HANDLE EXPLORERS                                 | 54      |
| NOYES GUM SCISSORS                                      | 105     |
| <b>O</b>  |         |
| OBTUSE IMPLANTOLOGY                                     | 161     |
| OCCULSION ANATOMY INSTRUMENT                            | 148     |
| OH - PERIOSTEEL ELEVATORS                               | 120     |
| OLSEN-HEGAR NEEDLE HOLDER WITH SCISSORS                 | 107     |
| OMEGA LOOP FORMING PLIERS                               | 141     |
| ORBAN SCALER  | 54      |
| ORTHO BAND PUSHER SCALER                                | 131     |
| ORTHO INSTRUMENT  | 130     |
| ORTHO LIGATURE DIRECTOR SINGLE ENDED                    | 131     |
| ORTHO LIGHT BAND PUSHER SCALER                          | 129     |
| ORTHO LIGHT DOUBLE ENDED LIGATURE                       | 131     |
| ORTHO LIGHT DOUBLE ENDED LIGATURE DIRECTOR              | 131     |
| ORTHO LIGHT DOUBLE ENDED LIGATURE DIRECTOR SCALER       | 129,131 |
| ORTHO LIGHT DOUBLE ENDED LIGATURE SCALER                | 131     |
| ORTHO LIGHT LIGATURE DIRECTOR DOUBLE ENDED              | 131     |
| ORTHO LIGHT SCALER                                      | 130     |
| ORTHO LIGHT SCALER DOUBLE ENDED                         | 130     |
| ORTHO LIGHT SCALER HEAVY                                | 130     |
| ORTHO LIGHT SCALER SINGLE ENDED                         | 131     |
| ORTHO RULER / CONE SOCKET                               | 146     |
| ORTHODONTIC INSTRUMENTS                                 | 129,131 |
| ORTHODONTICS PLIERS STANDS                              | 144     |
| ORTHOLITE LIGATURE DIRECTOR SCALER                      | 131     |
| OSTEOMETER MEASURING FORCEPS FOR JAW                    | 146     |
| OSTEOTOME CONVEXES / CONCAVE / CONIQUES                 | 171,172 |
| OSTEOTOME CONVEXES / CONCAVE / CONIQUES SET OF 5 PIECES | 172     |
| <b>P</b>  |         |
| PK THOMS WAXING INSTRUMENTS KIT                         | 89      |
| PK THOMS WAXING INSTRUMENTS SOLID HANDLE                | 89      |
| PALATAL-ADULT DENTAL PHOTOGRAPHIC MIRRORS               | 98      |
| PALATAL-ADULT LARGE DENTAL PHOTOGRAPHIC MIRRORS         | 98      |
| PALATAL-CHILD DENTAL PHOTOGRAPHIC MIRRORS               | 96      |
| PALMER RUBBER DAM CLAMPS FORCEPS                        | 111     |
| PAMILY EXTRACTING FORCEPS (AMERICAN PATTERN)            | 16      |
| PARTSCH PERIOSTEEL ELEVATORS                            | 120     |
| POL ELEVATORS   | 47, 49  |
| POL ELEVATORS SET OF 7 PCS                              | 47      |
| POL ELEVATORS SET OF 7 PCS                              | 47      |
| POL ELEVATORS SET OF 8 PCS                              | 48      |
| PEDIATRIC TOOTH EXTRACTING FORCEPS SET                  | 38      |
| PEET SPLINTER FORCEPS                                   | 109     |
| PERFORATED WITH RIM LOCK SET OF 06 PCS                  | 179     |
| PERFORATED WITH RIM LOCK SET OF 10 PCS                  | 179     |
| PERFORATED WITH RIM LOCK SET OF 8 PCS                   | 179     |
| PERIODONTAL CHISELS                                     | 118     |
| PERIODONTAL INSTRUMENTS                                 | 120,122 |
| PERIODONTAL KNIVES                                      | 54      |
| PERIODONTAL PROBES                                      | 58      |
| PERIODONTAL PROGRESSPREADERS                            | 57      |
| PERIODONTAL SURGERY                                     | 162     |
| PERIOSTEEL  |         |
| ELEVATORS   | 120,154 |
| PERIOTOME ROOTS ELEVATOR                                | 43      |
| PERRY TWEEZERS  | 52,53   |
| PHYSIC EXTRACTING FORCEPS (AMERICAN PATTERN)            | 16      |
| PIN & LIGATURE CUTTER                                   | 142     |
| PIN & LIGATURE CUTTERS TC                               | 139     |
| PIN HOLDING PLIER TC                                    | 140     |
| PIN-TWEEZERS  | 170     |
| PLAIN MOUTH MIRRORS                                     | 49      |
| PLANATOR  | 69      |
| PLANATOR  | 68      |
| PLASTER KNIFE   | 96      |
| PLASTER SHEARS  | 124     |
| PLASTIC FILLING INSTRUMENTS                             | 93      |
| PLIER STAND PLASTIC                                     | 144     |
| PLIER STAND STAINLESS STEEL                             | 144     |
| PLIERS FOR ORTHODONTICS & PROSTHETICS                   | 132,143 |
| PLIERS STAND STAINLESS ROD (ALUMINIUM ANODIZED)         | 144     |
| PLUGGERS  | 56      |
| PLUGGERS/CONDENSERS                                     | 87      |
| POSITIONING 3 IMPLANTOLOGY                              | 161     |

| DESCRIPTION   | PAGE#        |
|---|--------------|
| POSITIVE POSITIONER                                     | 125          |
| POSTERIOR BAND REMOVING PLIERS - LONG                   | 141          |
| POSTERIOR BAND REMOVING PLIERS - SHORT                  | 141          |
| POTTS "T-HANDLE" ELEVATOR-LEFT                          | 41           |
| POTTS "T-HANDLE" ELEVATOR-RIGHT                         | 41           |
| PRICHARD PERIODONTAL INSTRUMENTS                        | 121          |
| PROBE EXPLORERS   | 51           |
| PRONG 3 CLASP ADJUSTABLE PLIER TC                       | 140          |
| <b>Q</b>  |              |
| QUATRO DENTAL SYRINGES                                  | 27           |
| <b>R</b>  |              |
| RASPATOR, PRICHARD                                      | 165          |
| RASPATOR, RASPIATORY                                    | 120          |
| RASPATOR, WILLIGER                                      | 120          |
| RECTANGULAR ARCH BENDING PLIERS                         | 143          |
| RETRACTOR SELDIN  | 103          |
| RETRACTORS - MOUTH GAGS                                 | 86,100       |
| RETRACTORS  | 107to103     |
| RHODOUM MOUTH MIRRORS                                   | 49           |
| RIBBON RETRACTORS                                       | 101          |
| RIDGE MAPPING DOUBLE CALIPER                            | 140          |
| RING 2 DENTAL SYRINGES                                  | 27           |
| ROCHESTER-KOCHER HAEMOSTATIC FORCEPS                    | 110          |
| ROCHESTER-PEAN HAEMOSTATIC FORCEPS                      | 110          |
| ROOT CANAL PLUGGER                                      | 29to48       |
| ROOT ELEVATOR   | 29to48       |
| ROOT ELEVATORS SET OF 10 PCS                            | 46           |
| ROOT FRAGMENT FORCEPS                                   | 09,11        |
| ROOT PICK ELEVATOR WITH GOLD FLEXIBLE POINTS            | 42           |
| ROOT PLANNING FILES                                     | 119          |
| ROOT PLANNING FILES & BCME FILES                        | 119          |
| ROOTS SPLINTER FORCEPS                                  | 10           |
| ROSER-KÖNIG RETRACTORS - MOUTH GAGS                     | 100          |
| ROUND AND CONCAVE PLIER                                 | 139          |
| ROUND ENDOODONTIC BOXES                                 | 186          |
| ROUND EXCAVATOR   | 86           |
| ROUND TORQUE WRENCH UNIVERSAL                           | 177          |
| ROUTURIER EXTRACTING FORCEPS (ENGLISH PATTERN)          | 03           |
| ROUTURIER EXTRACTING FORCEPS FOR LOWER MOLARS           | 03           |
| RUBBER DAM CLAMPS                                       | 113          |
| RUBBER DAM CLAMPS FORCEPS                               | 111          |
| RUBBER DAM CLAMPS KITS                                  | 112          |
| RUBBER DAM FRAME  | 111          |
| RUBBER DUM TEMPLATE                                     | 112          |
| RULER   | 127          |
| RULER WEDGE   | 127          |
| RUSSIAN LONG TISSUE FORCEPS                             | 170          |
| RUSSIAN TISSUE FORCEPS                                  | 170          |
| RYDER NEEDLE HOLDERS                                    | 106,107      |
| <b>S</b>  |              |
| SAW BLADES  | 124          |
| SCALER  | 59to67       |
| SCALERS TRAYS   | 183          |
| SCALPEL HANDLE STRAIGHT                                 | 123          |
| SCALPEL HANDLES   | 123          |
| SCHLEMMER ROOTS ELEVATOR                                | 37           |
| SCHWILIN PERIODONTAL INSTRUMENTS                        | 122          |
| SCHURE BAND SEATER                                      | 130          |
| SCHWARTZ PLIERS   | 139          |
| SEPARATING ELASTIC PLIER                                | 111          |
| SELDEN PERIODONTAL INSTRUMENTS                          | 112          |
| SELDMAN ROOT ELEVATORS                                  | 29,32        |
| SELF-LOCKING GROOVED                                    | 169          |
| SELF-LOCKING TWEEZER                                    | 53           |
| SEMKEN TAYLOR TWEEZERS                                  | 52           |
| SENN MUELLER RETRACTOR                                  | 102          |
| SERRATED PLUGGERS                                       | 84           |
| SET OF 5 PIECES   | 171          |
| SHEPHERD'S HOOK EXPLORER                                | 54           |
| SHORT IMPLANT DRILLS                                    | 178          |
| SICKLE SCALERS  | 63           |
| SIMPLEX RETRACTOR                                       | 100          |
| SINUS ELEVATOR & MEMBRANE LIFT TIPS                     | 164          |
| SINUS IMPLANTOLOGY                                      | 156,161      |
| SINUS LEFT ELEVATOR & MEMBRANE LIFT TIPS 3 SET OF 7 PCS | 164          |
| SINUS LEFT ELEVATOR SET OF 10 PCS                       | 158          |
| SINUS LIFT ELEVATOR                                     | 151,157      |
| SINUS LIFT ELEVATORS SET OF 7 PCS WITH CASSETTE         | 152          |
| SINUS LIFT INSTRUMENT                                   | 150to152,161 |
| SINUSLIFT IMPLANTOLOGY                                  | 150,161      |
| SIOVELAND RETAINERS                                     | 115          |
| SLIM WEINGART PLIERS                                    | 141          |
| SLIPPER TWEEZERS  | 128          |
| SMAHA ELASTOMERIC LIGATURE PLACING FORCEPS              | 140          |
| SMALL/MEDIUM BALL BURNISHER                             | 149          |
| SOFT BRUSHING KIT SET OF 8 PCS                          | 163          |
| SOFT WIRE AND LIGATURE CUTTER                           | 135          |
| SOFT WIRE AND LIGATURE CUTTER, STANDARD                 | 135          |
| SPATULAS  | 73           |
| SPATULAS ROUNDED AND SHARP                              | 72           |
| SPECIAL INOX  | 124          |
| SPECIAL INOX WAX KNIVES                                 | 96           |
| SPENCER GUM SCISSORS                                    | 105          |
| SPRIFT LAMP   | 186          |
| SPLINTER FORCEPS  | 10           |
| SPOON AND PUSHER (TRINOVO)                              | 167          |
| STANDARD LIGATURE CUTTER TC                             | 139          |
| STAR TORQUE WRENCH UNIVERSAL                            | 177          |
| STERILIZING BOXES & INSTRUMENTS TRAYS                   | 184          |
| STERILIZING MESH TRAY                                   | 190          |
| STERNBERG RETRACTORS                                    | 86           |
| STIEGLITZ ROOT FRAGMENTS                                | 10           |
| STIEGLITZ SPLINTER FORCEPS                              | 10           |
| STOCKES RUBBER DAM CLAMPS FORCEPS                       | 111          |
| STOP PLIERS V-BESO                                      | 137          |
| STRAIGHT DIRECT BOND BRACKET REMOVER TC                 | 140          |
| STRIP SAW   | 125          |
| SUCTION CANNULA KIT WITH 3 NEEDLES                      | 178          |
| SUCTION NEEDLE  | 178          |
| SUCTION PIPE  | 178          |
| SUCTION TUBES   | 178          |
| SURGICAL TWEEZERS                                       | 52           |

| DESCRIPTION  | PAGE#       |
|--|-------------|
| SURGICAL BALL HOOK CRIMPING PLIERS, ANGLED                 | 137         |
| SURGICAL BALL HOOK CRIMPING PLIERS, STRAIGHT               | 137         |
| SURGICAL CHISELS   | 162         |
| SUTURE PLIERS SUTURE FORCEPS                               | 169         |
| SWEDISH TYPE DENTAL SYRINGES                               | 27          |
| SYNDEMOTOMES ROOTS ELEVATOR                                | 43          |
| <b>T</b>   |             |
| TAMPER   | 166         |
| TANNER FILLING INSTRUMENTS                                 | 88          |
| TARTAR REMOVER INSTRUMENTS SOLID HANDLE                    | 67          |
| TAYLOR SCALER  | 63          |
| THICK EXPLORERS  | 54          |
| THREE JAW PLIERS   | 143         |
| TISSUE GRAFT FORCEP SERRATED TEETH                         | 169         |
| TISSUE MEMBRANE FORCEPS                                    | 169,170     |
| TISSUE PUNCH   | 173         |
| TISSUE PUNCH FORCEPS TO REMOVE TISSUE AFTER USING PUNCH    | 170         |
| TISSUE PUNCH SET OF FIVE PIECES                            | 173         |
| TISSUE PUNCH STRAIGHT & CURVED                             | 173         |
| TISSUE PUNCH WITH PIN SET OF FOUR PIECES                   | 173         |
| TITANIUM LOCKING PLIER                                     | 169         |
| TITANIUM PERIOSTEAL ELEVATOR FOR IMPLAN                    | 122         |
| TOFFLEMIRE-JUNIER SIOVELAND RETAINERS                      | 115         |
| TOFFLEMIRE-SENIOR SIOVELAND RETAINERS                      | 115         |
| TOMAS EXTRACTING FORCEPS (AMERICAN PATTERN)                | 17,22       |
| TOMAS NEEDLE HOLDERS                                       | 102         |
| TORQUE WRENCH & RATCHET                                    | 177         |
| TORQUING PLIERS SET  | 137         |
| TOWNER-JAQUETTE SCALER                                     | 63          |
| TREPPIE  | 175         |
| TREPPIE DRILL SET OF EIGHT PIECES                          | 175         |
| TRIMCO HANDLE  | 167         |
| TRIO DENTAL SYRINGES                                       | 27          |
| TRIPLE-ANGLED BACK ACTION EXCAVATOR                        | 86          |
| TWEED / ANGEL FORMING AND TORQUING PLIERS                  | 134         |
| TWEED / ANGEL RECTANGULAR ARCH FORMING AND TORQUING PLIERS | 137         |
| TWEED / ANGLE RECTANGULAR ARCH FORMING & TORQUING PLIERS   | 133         |
| TWEED LOOP FORMING PLIERS                                  | 132,133,143 |
| TWEEZERS   | 52,53       |
| TWEEZERS EXPLORERS   | 51          |
| TWEL-ON ELASTIC MODULE INSTRUMENT                          | 130         |
| TYPE C DENTAL SYRINGES                                     | 27          |
| <b>U</b>   |             |
| UNIQUE RETRACTORS  | 102         |
| UNIVERSAL CROWN REMOVER                                    | 114         |
| UNIVERSAL CURETTES   | 63          |
| UNIVERSAL CUT & HOLD DISTAL END CUTTER                     | 142         |
| UNIVERSAL DOLPHIN STYLE WIRE BENDING & CUTTING PLIERS      | 132         |
| UNIVERSAL EXTRACTING FORCEPS (AMERICAN PATTERN)            | 22          |
| UNIVERSAL MINI-ELEVATOR FOR FRAGMENTS                      | 34          |
| UNIVERSAL NEEDLE HOLDERS                                   | 106         |
| UNIVERSITY OF MICHIGAN EXPLORERS                           | 55          |
| UNIVERSITY OF NORTH CAROLINA EXPLORER                      | 55          |
| UPPER ROOT ELEVATOR WITH HELICOIDAL TIP                    | 31          |
| US ARMY RETRACTORS   | 102         |
| UTILITY PLIER WEINGART TC                                  | 140         |
| <b>V</b>   |             |
| V BEND STOP  | 135         |
| V BEND STOP PLIER TC                                       | 139         |
| VERNIER GAUGE  | 127         |
| VISTA TUNNELING INSTRUMENTS SET                            | 165         |
| <b>W</b>   |             |
| W BARRY ROOTS ELEVATOR                                     | 41          |
| WAHL BONE FILES  | 119         |
| WAKAI HEAT CARRIERS  | 57          |
| WALDSAWHS WIRE BENDING AND CUTTING PLIERS                  | 134         |
| WANGEN HOLDER  | 90          |
| WARD FILLING INSTRUMENTS                                   | 80          |
| WATER SYRINGE  | 116         |
| WAX KNIVES   | 96          |
| WAY 6 ADJUSTABLE ANGLED SCALPEL HANDLE                     | 123         |
| WEIDER RETRACTOR   | 99          |
| WEINGART PLIER   | 135         |
| WEINGART PLIER MEDIUM                                      | 132,134     |
| WEINGART PLIERS  | 141         |
| WEINGART UTILITY PLIERS                                    | 136         |
| WEINGART MINI UTILITY PLIERS                               | 136         |
| WEITLANER RETRACTORS - MOUTH GAGS                          | 100         |
| WERDELSTADT SCALER   | 67          |
| WESTCOTT BURNISHERS  | 68          |
| WESTCOTT FILLING INSTRUMENTS                               | 83          |
| WESTON CEMENT SPATULAS                                     | 85          |
| WHITE BURNISHERS   | 68          |
| WIDE SIOVELAND RETAINERS                                   | 115         |
| WILAND SCALER  | 85          |
| WILKINS/TUFTS EXPLORER                                     | 54          |
| WILLIAMS EXPLORERS   | 55          |
| WILLIAMS FILLING INSTRUMENTS                               | 81          |
| WINTER EXTRACTING FORCEPS (AMERICAN PATTERN)               | 12          |
| WINTER ROOTS ELEVATOR                                      | 41          |
| WIRE BENDING & LOOP FORMING PLIERS                         | 132         |
| WIRE BENDING AND LOOP FORMING PLIERS ANGLED (BIRD BEAK)    | 136         |
| WISDOM EXTRACTING FORCEPS                                  | 03          |
| WISDOM ROOT ELEVATOR                                       | 36          |
| WITZEL FORCEPS WITH ANATOMICAL HANDLE SET OF 3 PCS         | 09          |
| WITZEL FORCEPS WITH GOLD SET OF 3 PCS                      | 09          |
| WITZEL FORCEPS WITH HOLE AND SCREW PATTERN SET OF 3 PCS    | 08          |
| WITZEL ROOT FRAGMENT FORCEPS                               | 09          |
| WOODEN HANDLE WAX KNIVES                                   | 96          |
| <b>X</b>   |             |
| X RAY FILM HANGERS   | 94          |
| <b>Y</b>   |             |
| YOUNG TONGUE FORCEPS                                       | 110         |
| YOUNG WIRE BENDING & LOOP FORMING PLIERS                   | 132         |
| YOUNGER GOOD SCALER  | 63          |
| <b>Z</b>   |             |
| ZAHLE CEMENT SPATULAS                                      | 85          |



**ALLIED GROUP**  
of Industries

Manufacturer and Exporter of Dental & Surgical Instruments.

Postal Address: P.O.Box-608 S.I.E. Near Khayber Bank Sialkot 51310-Pakistan

Cell & WhatsApp No. +92-310-7880054

E-mail: [info@alliedgroupind.com](mailto:info@alliedgroupind.com) [www.alliedgroupind.com](http://www.alliedgroupind.com)

