





**Satterlee Saw**  
10-001 29cm  
Stainless Steel Ring Handle  
Straight tip, Straight shaft



**Charriere Bone Saw**  
10-002 27cm  
10-003 30cm  
10-004 34cm  
Straight tip, Straight shaft



**Charriere Saw**  
10-005 35cm  
Spare saw blades  
10-006 12mm  
10-007 15mm



**Charriere Bone Saw Complete**  
10-008 35.5cm  
Straight tip,  
Straight shaft



**Helferich-Bier Saw**  
10-009 39cm  
Spare saw blades  
10-010 3mm  
10-011 5mm  
10-012 5mm



**Charriere Saw**  
10-013 25 cm  
10-014 27 cm  
Double saw



**Engel Plaster Saw**  
10-015 15.5 cm



**Serra Gigli**  
10-016 30 cm  
10-017 40 cm  
10-018 50 cm



**Percy Amputation Shield**  
10-019 30.5cm  
Handles Detachable,  
Simple Pattern



**Putti Bone Rasp**  
10-020 27cm  
Double ended,  
One end curved up  
one end curved sideways

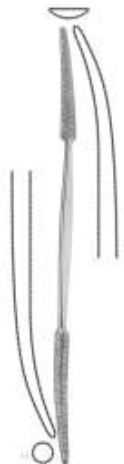

**Putti Rasp**  
10-021 30cm  
Double Ended



**Putti Bone File**  
10-022 28cm  
semicircular



**Putti Bone File**  
Bayonet Shape  
10-023 24.5cm  
X=13 mm  
semicircular



**Putti Bone File**  
10-024 22cm  
X=20 mm  
flat



**Joseph Bone Saw / Rasp**  
10-025 19cm  
Single Sided



**Linderman Amputation Saw**  
10-026 19cm  
20cm Blade



**Wellenschliff Nasal Saw**  
10-027 19cm  
Straight



**Langenbeck Metacarpal Saw**  
10-028 23cm  
11.5cm Blade

*Knochenfeilen*

*Limes à os*

*Limas para huesos*

*Lime per ossa*



**Patella Bone Saw**  
**10-029** Includes 1 blade  
**10-030** Replacement blade only  
 Delrin Handle



**Foman Rasp**  
**10-031** 21.5cm  
 Double ended, Fine & coarse serrations 4-sided convex and flat blades



**Foman Rasp**  
**10-032** 21cm

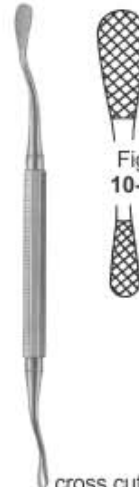

**Miller-Colburn Bone File**  
 18 cm



Fig. 1  
**10-033**



Fig. 2  
**10-034**

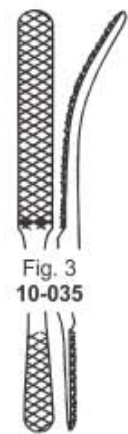

Fig. 3  
**10-035**



Fig. 4  
**10-036**

cross cut



**Kleinert-Kutz Bone Rasp**  
**10-037** 22.5cm  
 Double ended,  
 Fine & course serrations



**Miller Alveotomy File**  
**10-038** 19cm



**Miller Alveotomy File**  
**10-039** 19cm



**Gallaher Bone Rasp**  
**10-040** 18cm  
**10-041** 25cm  
 Curved



**Gallaher Bone Rasp**  
**10-042** 18cm  
**10-043** 25cm  
 Convex Curve



**Gallaher Bone Rasp**  
**10-044** 18cm  
**10-045** 25cm  
 Straight



**Good Bone File / Rasp**  
**10-046** 16.5cm  
 Straight



**Kistler Ear Cartilage Rasp**  
**10-047** left  
**10-048** right  
 16.5cm Curved



**Micro Rasp**  
**10-049** 14cm  
 Single ended  
 double sided



**Nail Rasp**  
**10-050** 17cm  
 Single sided



**Maltz Rasp**  
**10-051** 18cm  
 Single-Ended  
 Single sided



**Improved Maltz Rasp**  
**10-052** 18cm  
 Single-Ended,  
 up & down rasping



**Putti Rasp**  
**10-053** 23cm  
 falt / flat  
**10-054** 30.5cm  
 Round / flat

## RASPS, FILES

Raspeln, Feilen  
Rapes, Limes

Escofinas, limas  
Raspe, lime



**Miller Rasp**  
10-055 21.5cm  
Double Ended straight  
single Sided



**Fomon Rasp**  
10-056 21.5cm  
Double Ended straight  
single Sided  
one side concave



**Fomon Rasp**  
10-057 21.5cm  
Double Ended straight  
single Sided  
one side convex



**Fomon Rasp**  
10-058 21.5cm  
Double Ended straight  
single Sided



**Fomon Rasp**  
10-059 21.5cm  
Double Ended straight  
single Sided  
one side concave



**Fomon Rasp**  
10-060 21.5cm  
Double Ended straight  
single Sided  
one side convex



**Chisel Blade Handle**  
10-061 18.5cm



Chisel blades,  
interchangeable

10-062 8.5cm  
5mm  
10-063 8.5cm  
10mm  
10-064 8.5cm  
16mm  
10-065 8.5cm  
25mm



Osteotome blades,  
interchangeable

10-066 8.5cm  
5mm  
10-067 8.5cm  
10mm  
10-068 8.5cm  
16mm  
10-069 8.5cm  
25mm

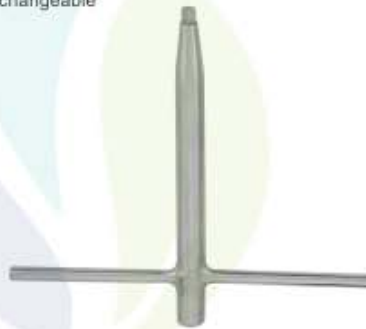

**Chisel Blade key**  
10-070 9cm



**Osteotome**  
13.5cm  
10-071 8mm  
10-072 10mm  
10-073 12mm  
10-074 14mm  
10-075 16mm



**Chisel**  
13.5cm  
10-076 8mm  
10-077 10mm  
10-078 12mm  
10-079 14mm  
10-080 16mm



**Gouge**  
13.5cm  
10-081 8mm  
10-082 10mm  
10-083 12mm  
10-084 14mm  
10-085 16mm



**Lucas Chisel**  
16cm  
10-086 3mm  
10-087 4mm  
10-088 5mm  
10-089 6mm



**Lucas Gouge**  
16cm  
10-090 3mm  
10-091 4mm  
10-092 5mm  
10-093 6mm



**U.S. Army Pattern  
Chisel**  
16.5 cm  
10-094 6 mm wide  
10-095 12 mm wide  
10-096 18 mm wide



Partsch Chisel	Partsch Chisel	Partsch Chisel
11.5cm	13.5cm	17.5cm
10-097 2mm	10-103 2mm	10-109 2mm
10-098 3mm	10-104 3mm	10-110 3mm
10-099 4mm	10-105 4mm	10-111 4mm
10-100 6mm	10-106 6mm	10-112 6mm
10-101 7mm	10-107 7mm	10-113 7mm
10-102 8mm	10-108 8mm	10-114 8mm

Knochenmeißel  
Ciseaux-burins, gouges

Cineles, gubias  
Scalpelli, sgorbi



Partsch Gouge	Partsch Gouge	Partsch Gouge
11.5cm	13.5cm	17.5cm
10-115 2mm	10-121 2mm	10-127 2mm
10-116 3mm	10-122 3mm	10-128 3mm
10-117 4mm	10-123 4mm	10-129 4mm
10-118 6mm	10-124 6mm	10-130 6mm
10-119 7mm	10-125 7mm	10-131 7mm
10-120 8mm	10-126 8mm	10-132 8mm



**Alexander Chisel**  
18cm

10-133 4mm
10-134 6mm
10-135 8mm
10-136 10mm
10-137 12mm
10-138 14mm



**Alexander Gouge**  
18cm

10-139 4mm
10-140 6mm
10-141 8mm
10-142 10mm
10-143 12mm
10-144 14mm



**Smith Peterson Gouge**  
20cm Straight

10-145 09 mm
10-146 14 mm
10-147 19 mm
10-148 25 mm

Curved

10-149 09 mm
10-150 14 mm
10-151 19 mm
10-152 25 mm



**Straight**

10-153 06 mm
10-154 09 mm
10-155 13 mm
10-156 16 mm
10-157 19 mm
10-158 25 mm
10-159 32 mm

**Curved**

10-160 06 mm
10-161 09 mm
10-162 13 mm
10-163 16 mm
10-164 19 mm
10-165 25 mm
10-166 32 mm

**Smith Peterson Osteotome**  
20 cm



**Straight**

10-167 10 mm
10-168 15 mm
10-169 20 mm
10-170 25 mm

**Curved**

10-171 10 mm
10-172 15 mm
10-173 20 mm
10-174 25 mm

**Stille Gouge**  
20 cm



**Stille**  
20 cm



**Stille Chisel**  
20 cm



10 mm  
10-185



15 mm  
10-186



20 mm  
10-187



25 mm  
10-188

**Chisels**

10-175 10 mm
10-176 12 mm
10-177 15 mm
10-178 20 mm
10-179 25 mm

**Osteotome**

10-180 10 mm
10-181 12 mm
10-182 15 mm
10-183 20 mm
10-184 25 mm



**Stille Osteotome**  
20 cm



10 mm  
10-189



15 mm  
10-190



20 mm  
10-191

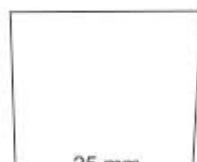

25 mm  
10-192



**Lexter Osteotome**  
22 cm

10-193 7 mm
10-194 10 mm
10-195 12 mm
10-196 15 mm
10-197 20 mm
10-198 25 mm
10-199 30 mm

**Lexter Modif. Osteotome**  
29 cm

10-200 7 mm
10-201 10 mm
10-202 12 mm
10-203 15 mm
10-204 20 mm
10-205 25 mm
10-206 30 mm



**Lexter Modif. Chisel**  
29 cm

10-207 7 mm
10-208 10 mm
10-209 12 mm
10-210 15 mm
10-211 20 mm
10-212 25 mm
10-213 30 mm

**Lexter Chisel**  
22 cm

10-214 7 mm
10-215 10 mm
10-216 12 mm
10-217 15 mm
10-218 20 mm
10-219 25 mm
10-220 30 mm



**Lexter Gouge**  
25 cm

10-221 7 mm
10-222 10 mm
10-223 15 mm

Straight

*Knochenmeißel*

*Cineles, gubias*

*Ciseaux-burins, gouges*

*Scalpelli, sgorbi*



**Lexer Gouge**  
25 cm  
10-224 7 mm  
10-225 10 mm  
10-226 15 mm  
Curved



**Lexer Osteotome Flat**  
22 cm  
10-227 10 mm  
10-228 15 mm  
10-229 20 mm  
10-230 25 mm



**Lexer Gouge Tuffnel Handle**  
22 cm  
10-231 10 mm  
10-232 15 mm  
10-233 20 mm  
10-234 25 mm



**Mini Lexer Osteotome**  
10-235  
18 cm



**Mini Lexer Chisel**  
10-236  
18 cm



**Capener Osteotome With Tuffnel Handle**  
25cm  
10-237 10mm  
10-238 12mm  
10-239 15mm  
10-240 20mm  
10-241 25mm  
10-242 30mm  
Straight



**Capener Osteotome With Tuffnel Handle**  
25cm  
10-243 10mm  
10-244 12mm  
10-245 15mm  
10-246 20mm  
10-247 25mm  
10-248 30mm  
Curved



**Capener Chisels With Tuffnel Handle**  
25cm  
10-249 6mm  
10-250 8mm  
10-251 10mm  
10-252 12mm  
10-253 15mm  
10-254 20mm  
10-255 25mm  
10-256 30mm  
Straight



**Capener Osteotome With Tuffnel Handle**  
25cm  
10-257 6mm  
10-258 8mm  
10-259 10mm  
10-260 12mm  
10-261 15mm  
10-262 20mm  
10-263 25mm  
10-264 30mm  
Curved



**Raspatories**  
10-265 20cm  
Medium straight blade  
round edge, width 14mm



**Raspatories**  
10-266 20cm  
Large straight blade  
round edge, width 20mm



**Raspatories**  
10-267 20cm  
Medium curved blade  
round edge, width 14mm



**Raspatories**  
10-268 20cm  
Large curved blade  
round edge, width 20mm



**Mini Lexer Osteotome**  
10-269 20cm  
18mm



**Raspatories**  
10-270  
28cm



**Raspatories**  
10-271  
28cm



**Chisel**  
10-272  
115mm/280mm  
for extraction of cement

Knochenmeißel

Cineles, gubias

Ciseaux-burins, gouges

ScalPELLi, sgorbi



**Chisel**  
10-273  
for extraction  
of cement 9mm  
Positive 400mm



**Chisel**  
10-274  
with 2 prong



**Lambotte  
Osteotome**  
25cm  
10-275 6mm  
10-276 8mm  
10-277 10mm  
10-278 13mm  
10-279 15mm  
10-280 20mm  
10-281 25mm  
10-282 30mm  
10-283 38mm  
10-284 44mm  
10-285 50mm  
Straight



**Lambotte  
Osteotome**  
25cm  
10-286 6mm  
10-287 8mm  
10-288 10mm  
10-289 13mm  
10-290 15mm  
10-291 20mm  
10-292 25mm  
10-293 30mm  
10-294 38mm  
10-295 44mm  
10-296 50mm  
Curved



**Mini-Lambotte  
Osteotome**  
12.5cm  
10-297 3mm  
10-298 4mm  
10-299 6mm  
10-300 8mm  
10-301 10mm  
10-302 12mm  
10-303 15mm  
Straight



**Mini-Lambotte  
Osteotome**  
17cm  
10-304 3mm  
10-305 4mm  
10-306 6mm  
10-307 8mm  
10-308 10mm  
10-309 12mm  
10-310 15mm  
Straight



**Lambotte Osteotome**  
12.5cm, Straight  
10-311 2mm tip width  
10-312 4mm tip width  
10-313 6mm tip width  
10-314 8mm tip width  
10-315 10mm tip width  
10-316 12mm tip width  
10-317 15mm tip width



**Hex Handle Osteotome**  
15cm, Straight  
10-318 2mm tip width  
10-319 3mm tip width  
10-320 4mm tip width  
10-321 5mm tip width  
10-322 6mm tip width  
10-323 7mm tip width  
10-324 9mm tip width  
10-325 10mm tip width



**Cottle Osteotome**  
18.5cm, Straight  
10-326 4mm tip width  
10-327 6mm tip width  
10-328 9mm tip width  
10-329 12mm tip width



**Anderson-Nievert  
Osteotome**  
20.4cm  
10-330 Curved right  
10-331 Curved left  
10-332 Straight



**Freer Gouge**  
10-333 15cm  
06mm



**Freer Chisel**  
10-334 16cm  
04mm



**Shoulder  
Penetrating Gouge**  
10-335 21.6cm  
Straight, 3mm distal tip



**Ballenger  
Chisel** 16cm  
10-336  
4mm  
10-337  
6mm  
10-338  
8mm



**Mannerfelt  
Modif.**



**Osteotomes**  
10-339 4mm  
10-340 6mm  
10-341 8mm  
15.5cm



**Gouge**  
10-342  
4mm  
15.5cm



**Kilian,  
Septum Gouge**  
10-343 16cm  
5mm



**Kilian-Claus  
Septum Gouge**  
10-344 16cm  
5mm

*Knochenmeißel*

*Cineles, gubias*

*Ciseaux-burins, gouges*

*Scalpelli, sgorbi*



**Stille**  
20cm



**Stille Chisel**  
10-345 10mm  
10-346 15mm  
10-347 20mm  
10-348 25mm  
Straight



**Stille Osteotome**  
10-349 10mm  
10-350 15mm  
10-351 20mm  
10-352 25mm  
Straight



**Stille Osteotome**  
10-353 10mm  
10-354 15mm  
10-355 20mm  
10-356 25mm  
Curved



**Stille Gouge**  
10-357 10mm  
10-358 15mm  
10-359 20mm  
10-360 25mm  
Straight



**Stille Gouge**  
10-361 10mm  
10-362 15mm  
10-363 20mm  
10-364 25mm  
Curved



**Smith-Petersen**  
20cm 8"



**Smith-Petersen osteotome**  
10-365 6mm  
10-366 9mm  
10-367 13mm  
10-368 16mm  
10-369 19mm  
10-370 25mm  
10-371 32mm  
Straight



**Smith-Petersen Osteotome**  
10-372 6mm  
10-373 9mm  
10-374 13mm  
10-375 16mm  
10-376 19mm  
10-377 25mm  
10-378 32mm  
Curved



**Smith-Petersen Gouge**  
10-379 9mm  
10-380 16mm  
10-381 19mm  
10-382 25mm  
Straight



**Smith-Petersen Gouge**  
10-383 9mm  
10-384 16mm  
10-385 19mm  
10-386 25mm  
Curved



**Hoke Osteotome**  
14cm  
10-387 3mm  
10-388 5mm  
10-389 7mm  
10-390 8.5mm  
10-391 10mm  
10-392 12mm



**Hibbs**  
24cm



**Hibbs Osteotome**  
10-393 6mm  
10-394 13mm  
10-395 19mm  
10-396 25mm  
10-397 32mm  
Straight



**Hibbs Chisel**  
10-398 6mm  
10-399 13mm  
10-400 19mm  
10-401 25mm  
10-402 32mm  
Straight



**Hibbs Osteotome**  
10-403 6mm  
10-404 13mm  
10-405 19mm  
10-406 25mm  
10-407 32mm  
Curved



**Hibbs Gouge**  
10-408 6mm  
10-409 13mm  
10-410 19mm  
10-411 25mm  
10-412 32mm  
Straight



**Hibbs Gouge**  
10-413 6mm  
10-414 13mm  
10-415 19mm  
10-416 25mm  
10-417 32mm  
Curved



*Knochenmeißel*  
*Ciseaux-burins, gouges*

*Cineles, gubias*  
*Scalpelli, sgorbi*

**Cottle Osteotome**  
10-418 7mm  
10-419 12mm  
15cm

**Cottle Osteotome**  
10-420 19cm  
04mm

**Cottle Osteotome with depth markings**  
10-421 18cm  
06mm

**Fomon Chisel**  
17cm

**Cinelli Chisel**  
18cm

**Cottle Osteotome**  
18cm

10-422 04mm  
10-423 07mm  
10-424 05mm  
10-425 08mm  
10-426 06mm

10-427 10mm  
10-428 12mm  
10-429 14mm  
10-430 16mm

10-431 04mm  
10-432 09mm  
10-433 07mm  
10-434 12mm

**Cottle Osteotomes**  
10-435 18cm  
16mm Protected and depth markings

**Cottle Chisel**  
18cm

**Cottle Osteotomes**  
10-440 18cm  
06mm Cross bar and depth markings

**Cottle Osteotomes**  
10-441 18cm  
16mm Cross bar and depth markings

**Hoke Osteotome**  
13.5cm  
Curved

**Walter Gouge**  
19cm

10-436 04mm  
10-437 09mm  
10-438 07mm  
10-439 12mm

10-442 3mm tip width  
10-443 4mm tip width  
10-444 6mm tip width  
10-445 8mm tip width  
10-446 10mm tip width  
10-447 13mm tip width  
10-448 16mm tip width  
10-449 19mm tip width

10-450 3mm  
10-451 4.5mm

10-452 4mm  
10-453 9mm  
10-454 7mm  
10-455 12mm

**Cottle Osteotome**  
20cm

**Rubin osteotome with stabilizer to reduce chance of twisting for more control**  
18cm

10-456 10mm  
10-457 12mm  
10-458 14mm

**Silver Rhinoplastic Chisel**

10-459 18cm Straight  
10-460 18cm right  
10-461 18cm Left

**Neivert-Anderson osteotome**

10-462 20cm Straight  
10-463 20cm right  
10-464 20cm Left

Meißel zur Nasenplastik

Osteotomes, ciseaux-burins pour rhinoplastique

Cinceles para rinoplastica

Scalpelli per plastica nasale

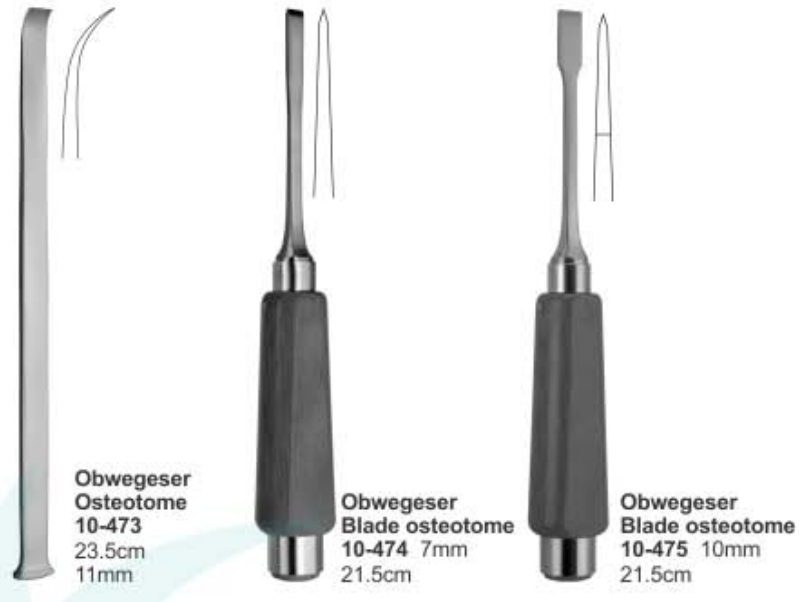
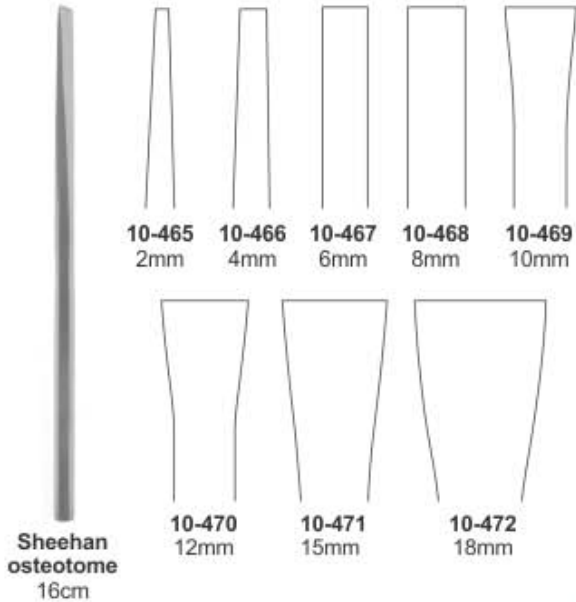

Hibbs Chisel	
22.5 cm straight	22.5 cm curved
10-485 6 mm	10-495 6 mm
10-486 9 mm	10-496 9 mm
10-487 12 mm	10-497 12 mm
10-488 15 mm	10-498 15 mm
10-489 18 mm	10-499 18 mm
10-490 20 mm	10-500 20 mm
10-491 25 mm	10-501 25 mm
10-492 30 mm	10-502 30 mm
10-493 35 mm	10-503 35 mm
10-494 40 mm	10-504 40 mm

  

Osteotomes	
22.5 cm straight	22.5 cm curved
10-505 6 mm	10-515 6 mm
10-506 9 mm	10-516 9 mm
10-507 12 mm	10-517 12 mm
10-508 15 mm	10-518 15 mm
10-509 18 mm	10-519 18 mm
10-510 20 mm	10-520 20 mm
10-511 25 mm	10-521 25 mm
10-512 30 mm	10-522 30 mm
10-513 35 mm	10-523 35 mm
10-514 40 mm	10-524 40 mm

Cobb Chisel	
27.5 cm straight	27.5 cm Curved
10-525 6 mm	10-532 6 mm
10-526 9 mm	10-533 9 mm
10-527 12 mm	10-534 12 mm
10-528 15 mm	10-535 15 mm
10-529 18 mm	10-536 18 mm
10-530 25 mm	10-537 25 mm
10-531 35 mm	10-538 35 mm

Osteotomes	
27.5 cm Straight	27.5 cm curved
10-539 6 mm	10-546 6 mm
10-540 9 mm	10-547 9 mm
10-541 12 mm	10-548 12 mm
10-542 15 mm	10-549 15 mm
10-543 18 mm	10-550 18 mm
10-544 25 mm	10-551 25 mm
10-545 35 mm	10-552 35 mm

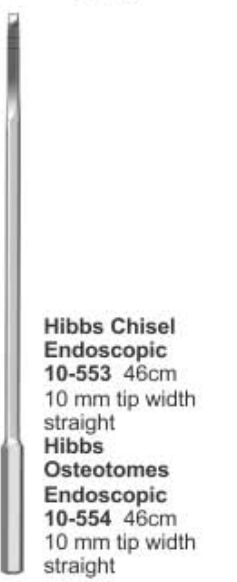

Hibbs Chisel / Osteotomes

Cobb Chisel / Osteotomes

# MALLETS

Hammer | Martillos  
Maillets | Martelli



**Doyen Mallets**  
25cm  
**10-555**  
25mmØ - 120g  
**10-556**  
30mmØ - 180g  
**10-557**  
35mmØ - 260g



**Collin Mallets**  
**10-558**  
20cm  
30mmØ - 220g



**Hajek Mallets**  
**10-559**  
21.5cm  
27mmØ - 140g



**Kirk Mallets**  
**10-560** 19cm  
38mmØ - 750g  
**10-561** 20.4cm  
Head diameter  
38.0mm,  
Weight: 1 lb. 4 oz.  
570 grams



**Partsch Mallets**  
**10-562** 18cm  
22mmØ - 200g



**Lucae Mallets**  
**10-563**  
19mmØ - 220g  
**10-564**  
25mmØ - 260g  
19cm



**Mallet Mallets**  
**10-565** 19cm  
250mmØ - 205g  
Solid steel, with  
plastic faces



**Cottle Mallets**  
**10-566**  
18.5cm  
30mmØ - 240g  
1 side flat /  
1 side convex



**Williger Hammer**  
**10-567** 250g  
**10-568** 350g



**Neufield Hammer**  
**10-569**



**Solid Copper  
Head Mallet**  
**10-570** 16.5cm  
Solid, Head  
diameter  
20mm



**Nylon Head Mallet**  
**10-571** 19cm  
Head diameter 25.4mm,  
7.76 oz.  
**10-572** 19.5cm  
Head diameter 3cm  
Weight 11 oz.



**Extra 3cm Nylon Face  
FOR 10-572**  
**10-573** Head diameter  
3cm



**Combination Mallet**  
**10-574** 19.5cm  
Solid, Head  
diameter 32.0mm,  
Weight 12 oz 340  
grams, Head weight:  
8 oz 227 grams



**Bergmann  
Mallets**  
**10-575**  
24.5cm  
45mmØ - 300g

## MALLETS

Hammer	Martillos
Maillets	Martelli



**Ombredanne Mallets**  
**10-576**  
24cm  
40mmØ - 550g



**Heath Mallets**  
**10-577** 18cm  
40mmØ - 700g  
**10-578** 20cm  
45mmØ - 1000g



**Williger Mallets**  
**10-579**  
28mmØ - 340g  
**10-580**  
30mmØ - 400g  
24cm  
Lead filled



**Hajek Hammer**  
**10-581** 250gm  
**10-582** 500gm



**Universal Hammer**  
**10-583** 500gm  
**10-584** 750gm



**Mallet, Lightweight**  
**10-585** 19cm  
Stainless Steel and Aluminum  
Head diameter 25.0mm  
Weight 7 oz 200 grams  
Head Weight: 4 oz 113 grams



**Nylon Caps Left & Right FOR 10-585 (PAIR)**  
**10-586**  
2.5cm



**Mallet #49**  
**10-587** 19.5cm  
Head diameter 22.0mm  
Weight 7 oz 200 grams  
Head Weight: 5oz/150 grams



**Mead Mallet**  
**10-588** 19cm  
Head diameter 26.0mm  
Weight 11 oz 315 grams  
Head Weight: 6 oz 170 grams



**Heath Mallet, Heavyweight**  
**10-589** 19cm  
Head diameter 40.0mm  
Weight 2 lbs. (907 grams)  
Head Weight: 20 oz (567 grams)



**Orthopedic Mallet**  
**10-590** 27.5cm  
Lightweight  
Solid, Head diameter 35.0mm  
Weight 2 lbs. (907 grams)  
Head Weight: 1 lb. (454 grams)



**Orthopedic Mallet**  
**10-591** 28cm  
Heavyweight  
Solid, Head diameter 50.0mm  
Head Weight: 2 lb. (900 grams)



**Ortho Mallets**  
**10-592**  
26.5cm (450g)



**Phenolic Handle Mallet**  
**10-593** 28 cm  
Head diameter 32mm  
Head weight 16 oz (454 grams)  
**10-594** Head diameter 45mm  
Weight 11 oz (312 grams);  
Head weight: 2 lbs (907 grams),



**Nylon Cap**  
**10-593**  
For Phenolic Handle Mallet

# MALLETS

<i>Hammer</i>	<i>Martillos</i>
<i>Maillets</i>	<i>Martelli</i>



**Reprocussion Free Mallet**  
Cap For 10-596

**Reprocussion Free Mallet**  
10-595 28cm  
Head diameter 30mm  
Weight 1lb 5 oz (595 grams)  
Head weight: 10 oz (283 grams)



**Mallet**  
10-597 26cm  
Plane (Nylon) convex (steel)  
Head 30mm Ø  
weight 675 grams.



**Mallet**  
10-598 26cm  
Head 42/30mm Ø  
weight 530 grams



**Mallet**  
10-599 26cm  
Plastic Handle  
head 30mm Ø  
weight 510 grams



**Vickers Mallets**  
10-600 19 cm  
25mmØ - 300g  
nylon disks plastic



**Herbert Mallets**  
10-601 19 cm  
25mmØ - 300g  
for ulnar head  
prosthesis plastic  
handle



**Mallet**  
10-602 18cm  
Made of Plastic  
Head 30mm Ø  
weight 125 grams



**Mallet**  
10-603 26 cm  
Made of Plastic  
with lead filling  
Head 42mm Ø  
weight 250 grams



**Mallet**  
10-604 22.5 cm  
Disks & Plastic Handle  
Head 37mm Ø  
weight 370 grams



**Mallet**  
26 cm  
Made of Plastic  
with lead filling  
10-606  
Head 42 mm Ø  
weight 400 grams  
10-607  
Head 42 mm Ø  
weight 250 grams



**Mallet**  
10-608 24cm  
Plastic Handle  
Head 30mm Ø  
weight 480  
grams



**Mallet**  
10-609



**Mallet**  
10-610



**Mallet**  
10-611



**Mallet**  
10-612

Raspatorien, Stobel  
Periostótomos, Pílons

Rugines-raspatoires, Punzones  
Periostotomi, Pestoni

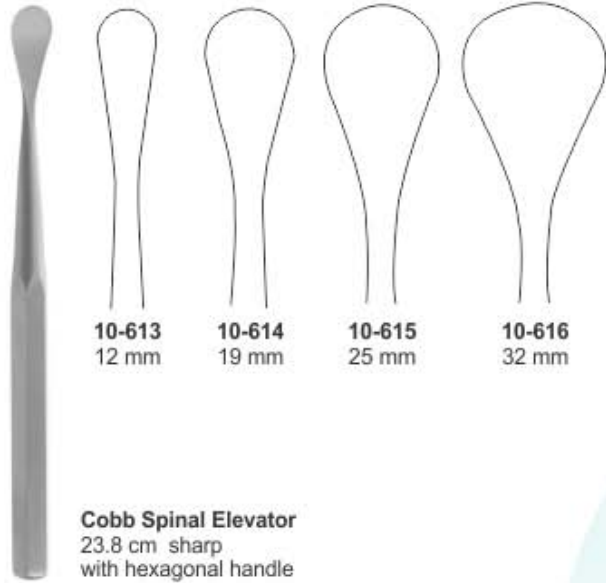

**10-613** 12 mm  
**10-614** 19 mm  
**10-615** 25 mm  
**10-616** 32 mm

**Cobb Spinal Elevator**  
23.8 cm sharp  
with hexagonal handle



**Harrington Spinal Elevator**  
**10-617** 30cm  
19 mm tip width  
Sharp

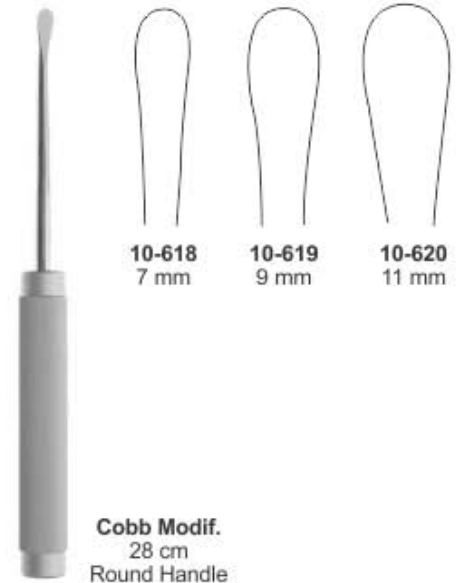

**10-618** 7 mm  
**10-619** 9 mm  
**10-620** 11 mm

**Cobb Modif.**  
28 cm  
Round Handle

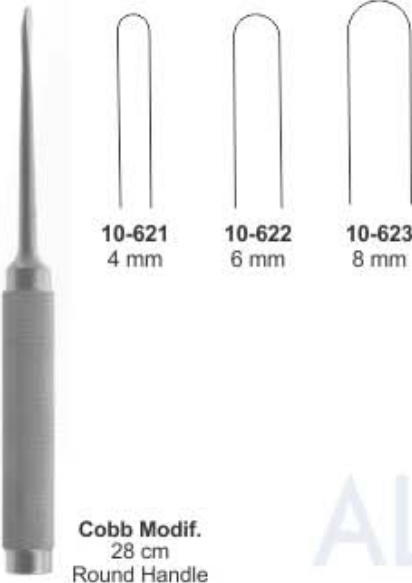

**10-621** 4 mm  
**10-622** 6 mm  
**10-623** 8 mm

**Cobb Modif.**  
28 cm  
Round Handle



**10-624**  
17.5 cm

**Sebileau Periosteal Elevator**



**10-625**  
15.5cm  
Head diameter  
2mm

**10-626**  
15.5cm  
Head diameter  
3mm

**10-627**  
15.5cm  
Head diameter  
4mm

**10-628**  
15.5cm  
Head diameter  
5mm

**10-629**  
15.5cm  
Head diameter  
6mm

**10-630**  
15.5cm  
Head diameter  
8mm

**10-631**  
15.5cm  
Head diameter  
10mm

**Bone Tamper**



**10-632**  
2.5mm x 2.5mm

**10-633**  
3.5mm x 3.5mm

**Passow Bone Tamper**  
12cm



**10-634**  
3mm

**10-635**  
5mm

**10-636**  
8mm

**Caspar Bone Tamper**  
20cm



**10-637**  
12mm

**10-638**  
14mm

**10-639**  
16mm

**Caspar Bone Tamper**  
20cm



**Tip Size**  
2 mm  
3 mm  
4 mm  
5 mm  
6 mm  
8 mm  
10 mm

**Bone Tamps**  
**10-640**  
15.4 cm

# BONE CURETTES

*Scharfe Löffel*  
Curettes tranchantes

*cucharillas cortantes*  
Cucchiai taglianti



**Volkman Bone Curette**

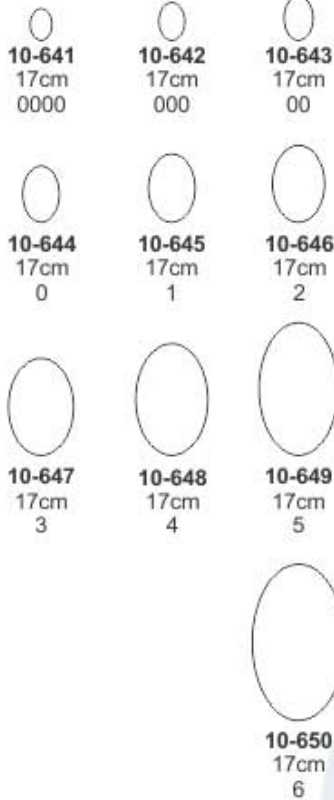

10-641  
17cm  
0000

10-642  
17cm  
000

10-643  
17cm  
00

10-644  
17cm  
0

10-645  
17cm  
1

10-646  
17cm  
2

10-647  
17cm  
3

10-648  
17cm  
4

10-649  
17cm  
5

10-650  
17cm  
6



**Schede Bone Curette**  
17cm

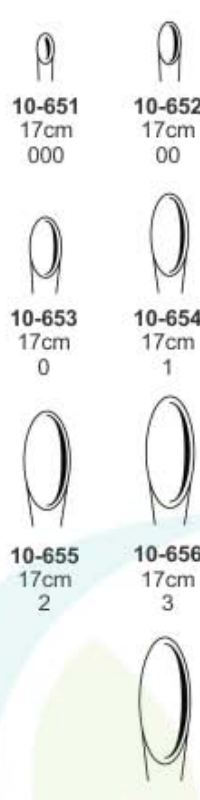

10-651  
17cm  
000

10-652  
17cm  
00

10-653  
17cm  
0

10-654  
17cm  
1

10-655  
17cm  
2

10-656  
17cm  
3

10-657  
17cm  
4



**Bruns Bone Curette**

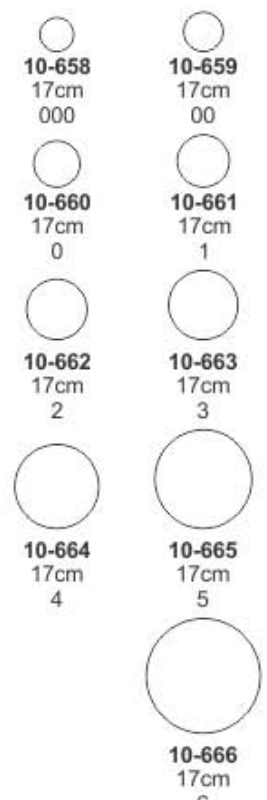

10-658  
17cm  
000

10-659  
17cm  
00

10-660  
17cm  
0

10-661  
17cm  
1

10-662  
17cm  
2

10-663  
17cm  
3

10-664  
17cm  
4

10-665  
17cm  
5

10-666  
17cm  
6



**Spratt Bone Curette / Hollow Handle**

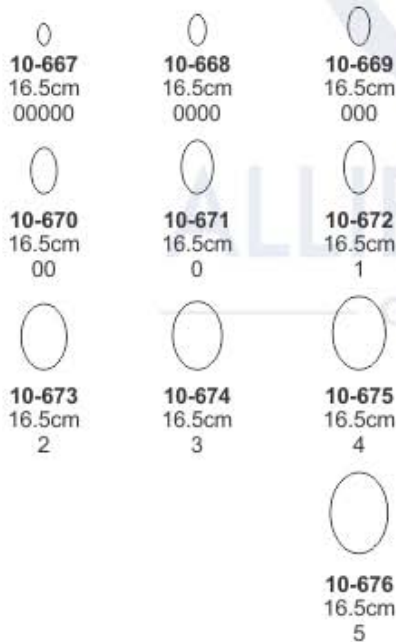

10-667  
16.5cm  
00000

10-668  
16.5cm  
0000

10-669  
16.5cm  
000

10-670  
16.5cm  
00

10-671  
16.5cm  
0

10-672  
16.5cm  
1

10-673  
16.5cm  
2

10-674  
16.5cm  
3

10-675  
16.5cm  
4

10-676  
16.5cm  
5



**Halle Bone Curette Flexible**



10-677  
21cm  
1

10-678  
21cm  
2

10-679  
21cm  
3



**Uffnorde Bone Curette Left**  
10-680 17.5cm



**Uffnorde Bone Curette Right**  
10-681 17.5cm

## BONE CURETTES

Scharfe Loffel  
Curettes tranchantes

cucharillas cortantes  
Cucchiai taglienti



**Bruns Bone  
Curette 23 cm**

Fig.1  
10-682

Fig.3  
10-684

Fig.5  
10-686

Fig.7  
10-688

Fig.2  
10-683

Fig.4  
10-685

Fig.6  
10-687

Fig.8  
10-689

Fig.9  
10-690



**Bone Curette  
Straight**

10-691  
20cm  
000

10-693  
20cm  
0

10-695  
20cm  
2

10-697  
20cm  
4

10-692  
20cm  
00

10-694  
20cm  
1

10-696  
20cm  
3

10-698  
20cm  
5

10-699  
20cm  
6



**Bone Curette  
Curved**

10-700  
20cm  
000

10-702  
20cm  
0

10-704  
20cm  
2

10-706  
20cm  
4

10-701  
20cm  
00

10-703  
20cm  
1

10-705  
20cm  
3

10-707  
20cm  
5

10-708  
20cm  
6



**Schroeder  
Bone Curette  
Sharp / rigid**

10-709  
30cm  
1

10-711  
30cm  
3

10-713  
30cm  
5

10-710  
30cm  
2

10-712  
30cm  
4

10-714  
30cm  
6



**Simon  
Bone Curette  
Sharp / rigid**

10-715  
24cm  
0000

10-719  
25cm  
1

10-722  
25cm  
4

10-716  
24cm  
000

10-720  
25cm  
2

10-723  
25cm  
5

10-717  
24cm  
00

10-721  
25cm  
3

10-724  
25cm  
6

10-718  
24cm  
0



# BONE CURETTES

Scharfe Löffel | cucharillas cortantes  
Curettes tranchantes | Cucchiai taglianti



- 10-725  
3.6mm  
000
- 10-726  
4.4mm  
00
- 10-727  
5.2mm  
0
- 10-728  
6.8mm  
1

**Bone Curette**  
25 cm  
Straight



- 10-729  
2.8mm  
0000
- 10-730  
3.6mm  
000
- 10-731  
4.4mm  
00
- 10-732  
5.2mm  
0

**Daubenspeck Bone Curette**  
20 cm



- 10-733  
Straight
- 10-734  
Down Angle
- 10-735  
Up Angle

**Scoville Bone Curette**  
25 cm



- 10-736  
1.8mm  
00000
- 10-737  
2.0mm  
0000
- 10-738  
2.4mm  
000
- 10-739  
2.6mm  
00
- 10-740  
2.8mm  
0

**Lempert Bone Curette**  
21.5 cm



- 10-741  
5 mm
- 10-742  
7 mm
- 10-743  
9 mm
- 10-744  
10 mm
- 10-745  
12 mm

**Cushing Bone Curette**  
23.5 cm  
Pituitary Spoon,  
malleable, silver-plated



- 10-746  
4 mm x 10 mm  
straight
- 10-747  
4 mm x 10 mm  
up angle
- 10-748  
4 mm x 10 mm  
down angle

**Scoville Bone Curette**  
25 cm  
Ruptured Disc Curette



- 10-749  
Ø 4 mm  
straight
- 30°  
10-750 Ø 3 mm  
10-751 Ø 4 mm  
10-752 Ø 5 mm
- 45°  
10-753 Ø 3 mm  
10-754 Ø 4 mm  
10-755 Ø 5 mm

**Tay-Bronson Bone Curette**  
22 cm  
Pituitary Curette, double-edged

## BONE CURETTES

Scharfe Löffel

cucharillas cortantes

Curettes tranchantes

Cucchiai taglienti

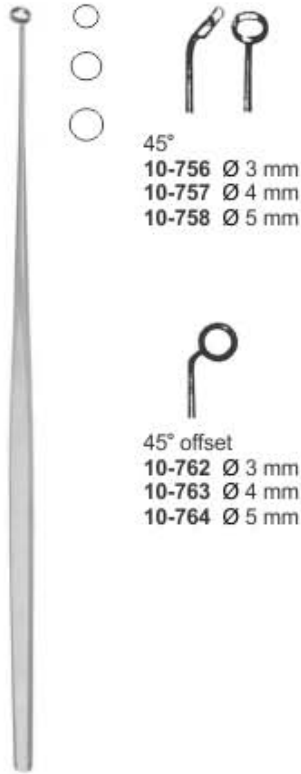

Ray Bone Curette, 19 cm  
Pituitary Curette

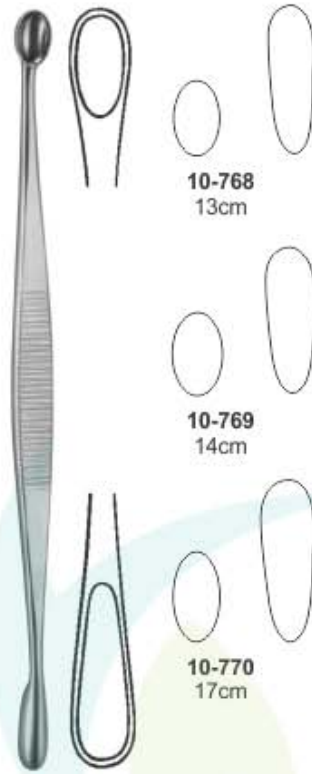

Volkmann  
Curette  
Oval / Oval

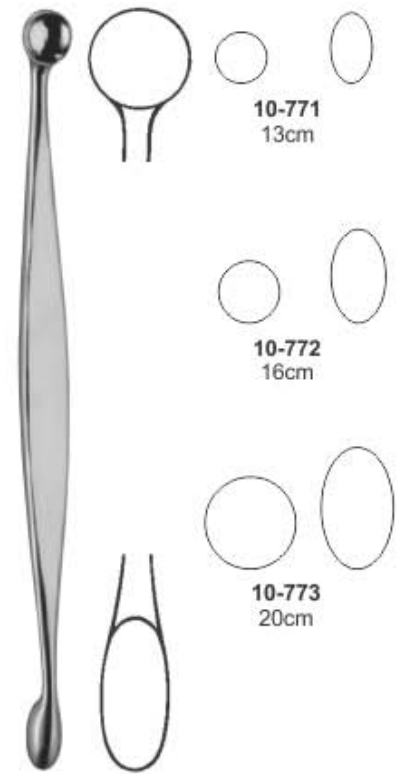

Volkmann  
Curette  
Round / Oval



Curette  
10-774  
21cm  
round / oval



Martini  
Curette  
13.5cm



Martini  
Curette  
15.5cm

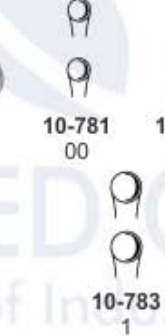

Williger  
Curette  
13.5cm



Williger  
Curette  
15.5cm



# BONE CURETTES

Scharfe Löffel | cucharillas cortantes  
Curettes tranchantes | Cucchiai taglienti

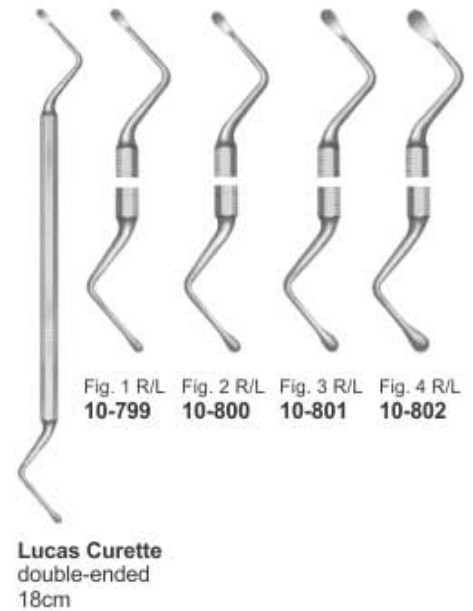
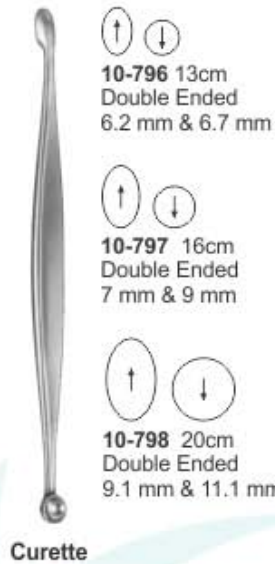

## PERIOSTEAL ELEVATORS

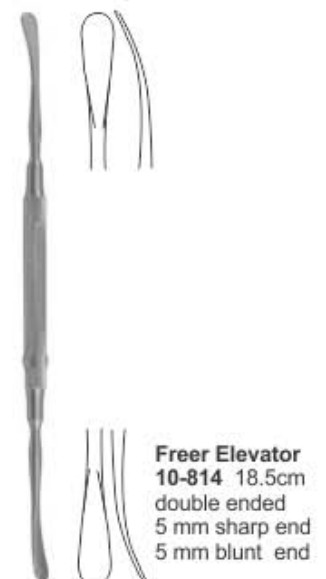
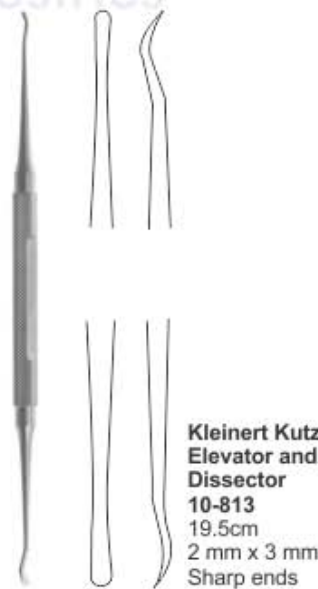

## PERIOSTEAL ELEVATORS

Raspatorien

Rugines-raspatoires

Periostótomos

Periostotomi

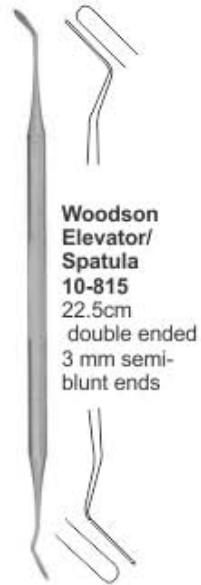

**Woodson Elevator/ Spatula 10-815**  
22.5cm  
double ended  
3 mm semi-blunt ends

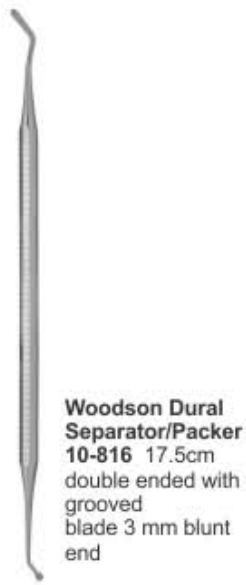

**Woodson Dural Separator/Packer 10-816** 17.5cm  
double ended with grooved blade 3 mm blunt end

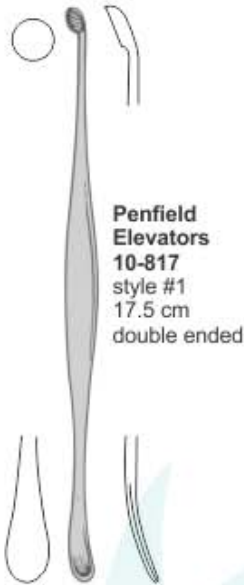

**Penfield Elevators 10-817**  
style #1  
17.5 cm  
double ended

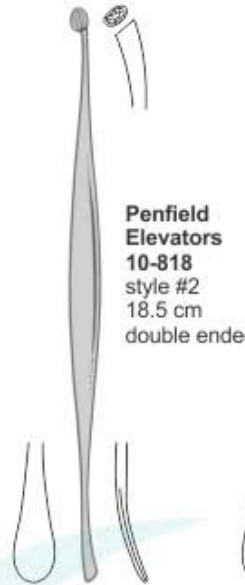

**Penfield Elevators 10-818**  
style #2  
18.5 cm  
double ended

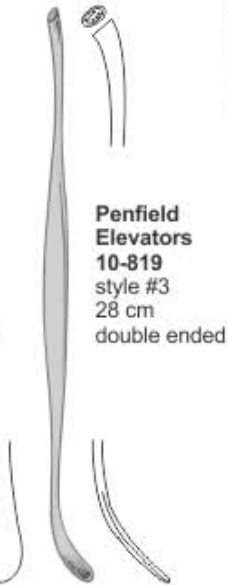

**Penfield Elevators 10-819**  
style #3  
28 cm  
double ended



**Penfield Elevators 10-820**  
style #4  
28 cm  
single ended

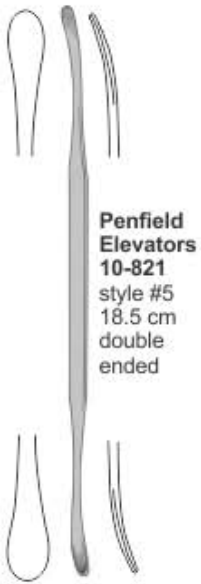

**Penfield Elevators 10-821**  
style #5  
18.5 cm  
double ended

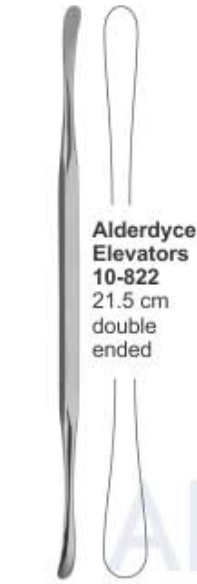

**Alderdyce Elevators 10-822**  
21.5 cm  
double ended



**Mc Donald Elevators 10-823**  
19 cm  
double ended



**Watson-Cheyne Elevators 10-824**  
19 cm  
double ended



**Obwegeser Needle 10-825**  
17.5cm



**Obwegeser Needle 10-826**  
23cm



**Obwegeser Needle 10-827**  
18cm



**Obwegeser Needle 10-828**  
14cm

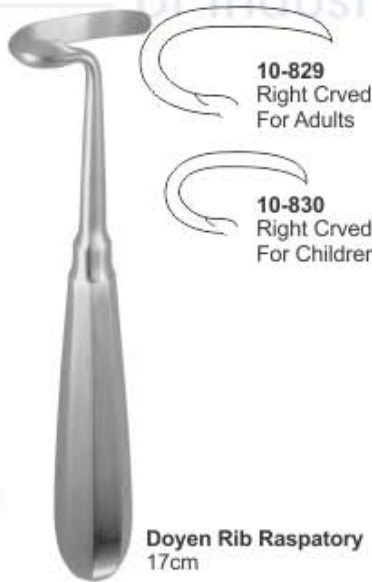

**Doyen Rib Raspatory 17cm**



**Doyen Rib Raspatory 17cm**



**Sedillot Elevator 10-833**  
18.5cm  
**10-834**  
21cm

# PERIOSTEAL ELEVATORS

Raspatorien | Rugines-raspatoires  
 Periostótomos | Periostotomi



**Crego Periosteal Elevator 10-835**  
15.5cm



**Williger Elevator 10-836**  
13cm  
5mm



**Williger Elevator 10-837** 4mm  
**10-838** 6mm  
16cm



**Williger Elevator 10-839**  
16cm  
5mm



**Williger Elevator 10-840**  
16cm  
6.5mm

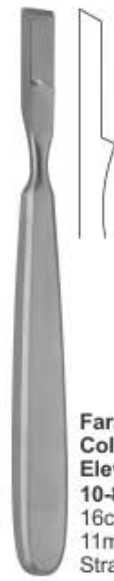

**Farabeuf-Collin Elevator 10-841**  
16cm  
11mm  
Straight



**Farabeuf-Collin Elevator 10-842**  
16cm  
11mm  
Curved

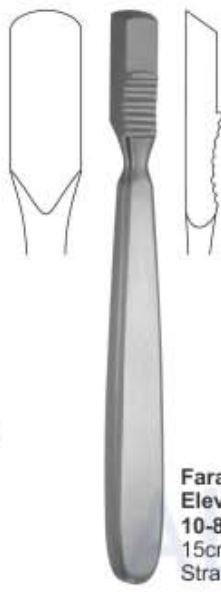

**Farabeuf Elevator 10-843**  
15cm  
Straight



**Farabeuf Elevator 10-844**  
15cm  
Curved



**Lambotte Elevator 10-845** 5mm  
**10-846** 10mm  
**10-847** 15mm  
**10-848** 20mm  
**10-849** 25mm  
21cm Straight

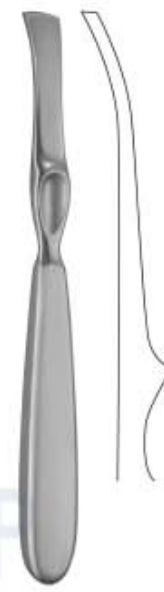

**Lambotte Elevator 10-850** 5mm  
**10-851** 10mm  
**10-852** 15mm  
**10-853** 20mm  
**10-854** 25mm  
21cm Curved



**Adson Elevator**

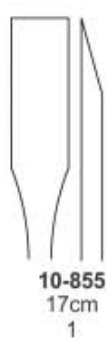

**10-855**  
17cm  
1



**10-856**  
17cm  
2



**10-857**  
17cm  
3



**10-858**  
17cm  
4

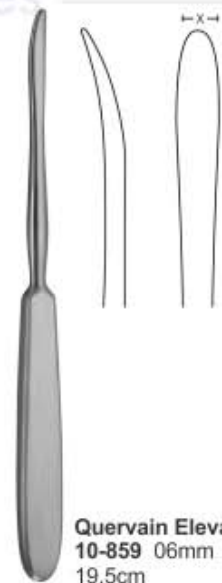

**Quervain Elevator 10-859** 06mm  
19.5cm

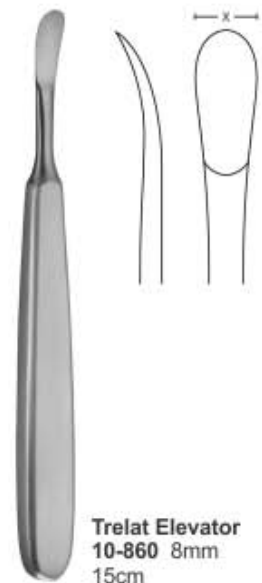

**Trelat Elevator 10-860** 8mm  
15cm

## PERIOSTEAL ELEVATORS

Raspatorien | Rugines-raspatoires  
Periostótomos | Periostotomi

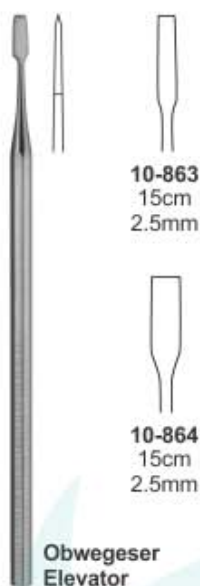
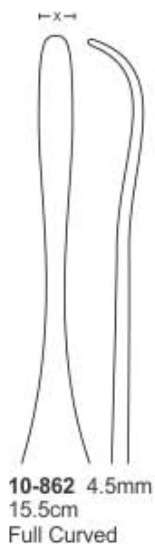
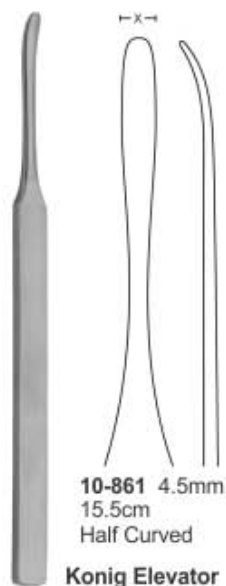

# PERIOSTEAL ELEVATORS

Raspatorien | Rugines-raspatoires  
 Periostótomos | Periostotomi

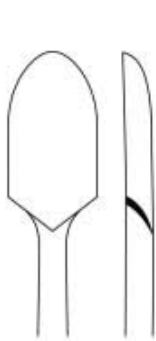

**10-879**  
14mm  
Straight  
1

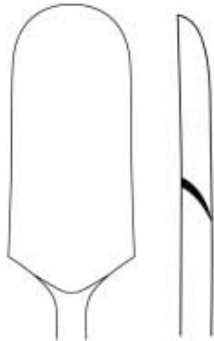

**10-880**  
20mm  
Straight  
3

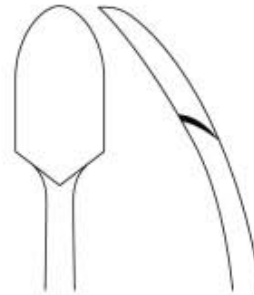

**10-881**  
14mm  
Curved  
2

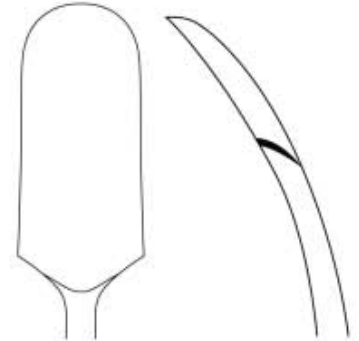

**10-882**  
20mm  
Curved  
3

**Ferozell Periosteal Elevator**  
20cm

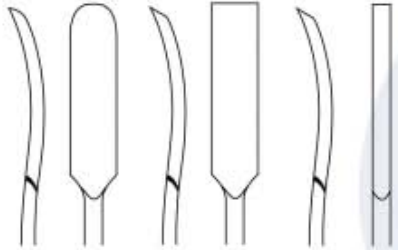

**10-883**  
6mm  
1

**10-884**  
3mm  
2

**10-885**  
6mm  
3



**Periosteal Raspatories**  
**10-886**  
18.5cm  
cvd



**Periosteal Elevator**  
**10-887** 18cm  
Fiber/Phenolic Handle  
blade 6mm



**Hoen Periosteal Elevator**  
**10-888**  
16.5cm

**Ferozell Periosteal Elevator**  
18cm



**Chandler Bone Elevator**  
**10-889** 19cm  
13 mm  
**10-890** 20cm  
20 mm  
**10-891** 23cm  
25 mm  
**10-892** 25cm  
31 mm



**Key Periosteal Elevator** 19cm  
**10-893**  
6 mm  
**10-894**  
12 mm  
**10-895**  
20 mm  
**10-896**  
25 mm  
sharp,  
slightly  
curved



**Pennybacker Periosteal Elevator**  
**10-897**  
6 mm  
17 cm sharp,  
curved



**Langenbeck Periosteal Elevator**  
**10-898**  
15 mm  
19 cm  
sharp, slightly  
curved



**Cushing Periosteal Elevator** 15 mm  
**10-899**  
Round Edge  
**10-900**  
Square Edge  
18 cm

## PERIOSTEAL ELEVATORS

Raspatorien  
Periostótomos

Rugines-raspatoires  
Periostotomi



**Hoen Periosteal Elevator**  
10-901 7mm, 16cm  
10-902 15mm, 19cm  
10-903 20mm, 19cm  
Semisharp



**Sayre Periosteal Elevator**  
10-904 17cm  
one straight blunt  
and one curved  
sharp



**Langenbeck Periosteal Elevator**  
10-905 7mm  
10-906 10mm  
20 cm Blunt

7 mm

10 mm



**Cushing Periosteal Elevator**  
19cm  
10-907  
Left  
10-908  
Right



**Cobb Periosteal Elevator**  
10-909 10mm  
10-910 13mm  
10-911 19mm  
29cm  
Spinal Raspatory

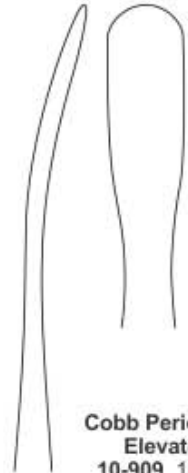

**Key Periosteal Elevator**



10-912  
18cm  
8mm



10-913  
19cm  
10mm



10-914  
19cm  
12mm

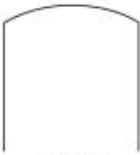

10-915  
20cm  
19mm



10-916  
21cm  
25mm



**Cobb Periosteal Elevator**  
10-917 23.4cm  
Hex Handle



**Darrach Elevator**  
10-918 26cm  
19mm  
10-919 35cm  
25.4mm  
Blunt, Slightly  
Curved



**Carroll Periosteal Elevator**  
10-920 14cm  
sharp, double ended  
3 mm round end,  
10 mm flat end



**Langenbeck Periosteal Elevator**  
19.5cm  
10-921  
blunt edge  
10-922  
sharp edge



**Key Periosteal Elevator sharp edge**  
10-923 17.7 cm 6.5 mm width  
10-924 18.5 cm 9.5 mm width  
10-925 18.5 cm 12.7 mm width  
10-926 20.0 cm 19.0 mm width  
10-927 20.9 cm 25.0 mm width



**Lane Bone Elevator**  
10-928  
16cm  
Serrated



**Lane Bone Elevator**  
10-929  
27cm



**Trethowan's Bone Elevator**  
10-930  
22cm



**Bristow's Bone Lever**  
10-931  
24cm



# PERIOSTEAL ELEVATORS, MENISCOTOMY KNIVES

Raspatorien, Meniskotome

Rugines-raspatoires, Bisturies para meniscos

Periostótomos, Bistouries a menisques

Periostotomi, Bisturi per menisco



**St. Thomas  
10-932**  
16cm  
Pointed



**St. Thomas  
10-933**  
16cm  
Rounded



**Robinson's  
10-934**  
17cm



**Freer D  
Septum  
Knife  
10-935**  
15cm



**Bircher  
Meniscotomy  
Knife  
10-936**  
19cm



**Matson  
Meniscotomy  
Knife  
10-937**  
22cm



**Downing  
Cartilage  
Knife  
10-938**  
25.5cm  
Curved tip,  
Straight shaft



**Smillie  
Meniscotomy  
Knife  
10-939** 16cm  
Straight Shaft  
Blade tip width  
is 7.8mm  
Straight tip



**Smillie  
Meniscotomy  
Knife  
10-940** 16cm  
Curved Shaft  
Blade tip width  
is 7.8mm  
Curved left tip



**Kanadisches  
Modell  
Meniscotomy  
knife  
10-941**  
20cm



**Kanadisches  
Modell  
Meniscotomy  
knife  
10-942**  
20cm



**Meniscotomy  
Knife  
10-943** 18cm



**Neff Meniscotomy  
Knife**

**10-944**  
22cm  
left



**10-945**  
22cm  
right



**10-946**  
4mm

**10-947**  
4.5mm

**10-948**  
5.5mm

**Bunnell Tendon  
Strippers**  
23cm  
Malleable shaft



**10-949**  
Fig. 1  
3mm

**10-951**  
Fig. 3  
5mm

**Bunnell  
Tendon  
Strippers**  
15.2cm

**10-950**  
Fig. 2  
4mm

**10-952**  
Fig. 4  
6mm

**10-953**  
Fig. 5  
7mm



**Fischer  
Tendon  
Strippers**  
10-954  
31cm

Sehnenstripper, Knochenhebel

enucleadores de tendones, Elevadores para huesos

Instruments a ecorcher les tendons, Leviers a os

Scollatendini, Elevatori per ossa



**Bunnell Tendon Strippers**  
10-955 23cm  
Tendon passer



**Kleinert-Kutz Tendon Retriever**  
10-956  
20cm  
Serrated



**Kleinert-Kutz Tendon Retriever**  
10-957  
20cm  
Serrated,  
flexible shaft



**Brand Tendon Tunelling Forceps**  
10-958 15cm  
10-959 19cm  
10-960 24cm  
Straight, serrated  
2 x 3 teeth



**Hohmann Bone Elevator**  
10-961 43mm  
24.5 cm



**Hohmann Bone Elevator**  
10-962 22mm  
26cm



**Hohmann Bone Elevator**  
10-963 33mm  
28cm



**Hohmann Bone Elevator**  
10-964 24mm  
26.5cm



**Hohmann Bone Elevator**  
10-965 22mm  
26cm



**Capsule Retractor**  
10-966 25.5cm  
3 sharp-pronged,  
22mm width blade



**Bristow-Bankart Humeral Retractor**  
10-967 19cm  
Double-pronged,  
25mm width x 102mm  
depth blade



**Bristow-Bankart Soft Tissue Retractor**  
10-968 20cm  
3-pronged  
21mm width blade,



**Humeral Head Retractor**  
10-969 22cm  
18mm width blade



**Hohmann Bone Elevator**  
10-970 22cm  
08mm width blade  
10-971 23cm  
10mm width blade



**Hohmann Bone Elevator**  
10-972 24cm  
18mm



**Hohmann Bone Elevator**  
10-973 24cm 70mm  
10-974 28.5cm 35mm width blade  
10-975 33cm 40mm width blade

# BONE LEVERS

*Knochenhebel* | *Elevadores para huesos*  
*Leviers a os* | *Elevatori per ossa*



**Hohmann Long Shank Retractor**  
**10-976** 23cm  
 43mm width blade



**Mini-Hohmann Bone Elevator**

**10-977** 16cm  
 6mm width blade



**10-978** 16cm  
 8mm width blade



**Hohmann Bone Lever**  
**10-979**  
 15cm



**Hohmann Bone Lever**  
**10-980**  
 15.4cm  
 Short tip



**Hohmann Retractor**  
**10-981**  
 15cm  
 15mm width blade



**Hayes Hand Retractor**  
**10-982**  
 16cm  
 3mm width blade



**Hayes Hand Retractor**  
**10-983**  
 15cm  
 6mm width blade



**10-984**  
 14cm  
 2.8mm



**10-985**  
 14cm  
 4.5mm

**10-986**  
 14cm  
 6mm



**Bristow Bone Lever**  
**10-987**  
 23cm



**Lane Bone Lever**  
**10-988**  
 21cm



**Periosteal Elevator** 17.5cm  
 For Metacarpals Small  
**10-989** 6 mm width  
 For Metacarpals Medium  
**10-990** 10 mm width  
 Light Curve, Rounded End,  
**10-991** 5 mm width  
 Contra Angled Curve  
**10-992** 4.5 mm width



1



2



3



4



**Hohmann Retractor**  
**10-993** 18cm  
 Small, width 6 mm  
 short, narrow tip



**Hohmann Retractor**  
**10-994** 18cm  
 Small, width 8 mm  
 short, narrow tip



**Hohmann Retractor**  
**10-995** 12.5cm  
 Finger Ring handle,  
 16mm width blade

## BONE LEVERS / FORCEPS

Knochenhebel / Pinzette | Palancas de hueso / Pinzas  
Leviers / pinces à os | Leve / pinze ossee



**Hohmann-Williger Retractor**  
10-996  
16cm

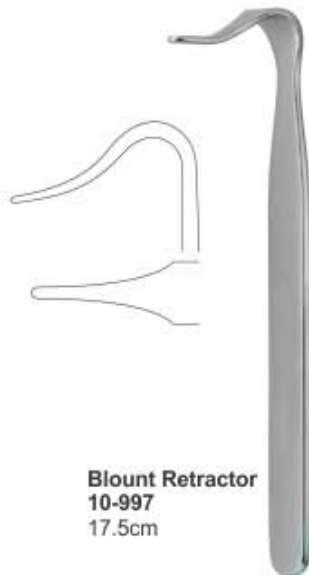

**Blount Retractor**  
10-997  
17.5cm

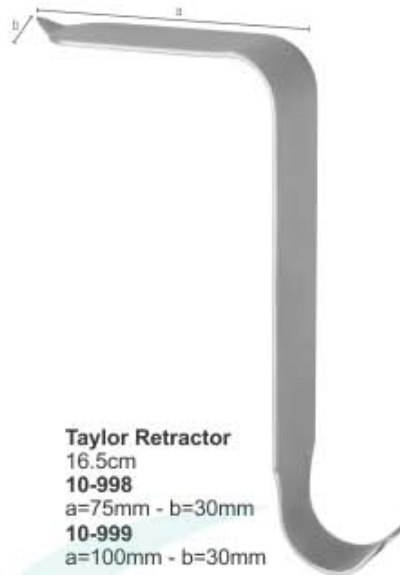

**Taylor Retractor**  
16.5cm  
10-998  
a=75mm - b=30mm  
10-999  
a=100mm - b=30mm



**Cushing Vein Retractor**  
10-1000 22.5cm  
with fenestrated handle  
Blade 12 mm width x 10 mm



**Cushing Decompression Retractor**  
10-1001 21.5cm  
with fenestrated blade and handle  
Blade 13 mm width x 22 mm



**Scoville Nerve Retractor**  
10-1002  
24cm  
7 mm straight



**Scoville Nerve Retractor**  
10-1003  
24 cm, 7 mm angled



**Taylor Retractor**  
17cm  
10-1004 30 x 75 mm  
10-1005 30 x 100 mm



**Hibbs Retractor**  
10-1006  
25 x 75 mm, 23cm  
10-1007  
25 x 80 mm, 24cm



**Meyerding Retractor**  
10-1008  
16 X 50 mm, 20cm  
10-1009  
25 X 75 mm, 23cm  
10-1010  
50 X 90 mm, 24cm



**Nail Extracting Forceps**  
10-1011  
14cm



**Nail Extracting Forceps**  
10-1012  
14.5cm

Orthopädie, Sehnenstripper

Orthopédie, enucleadores de tendones

Ortopedia, Instruments a ecorcher les tendons

Ortopedia, Scollatendini



10-1014 10-1015 10-1016

Frill points only

Finger Nail Drill with 3 drill points 10-1013



Nail Splitting Forceps 10-1017 13.5cm



10-1019 Saw Blade Only for 10-1018

Ring Cutter 10-1018 17cm



10-1021 Saw Blade Only for 10-1020

Ring Cutter 10-1020 17cm



Tendon Tunelling Forceps 10-1022 13cm



10-1023 15cm

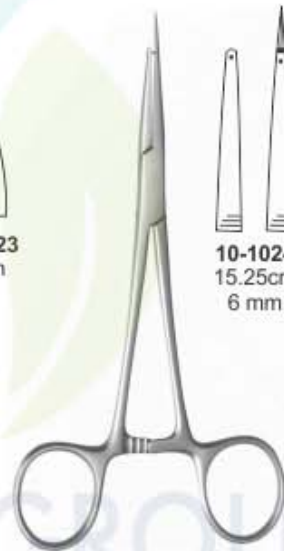

10-1024 15.25cm 6 mm



Lead Hand 10-1025 Adult Size

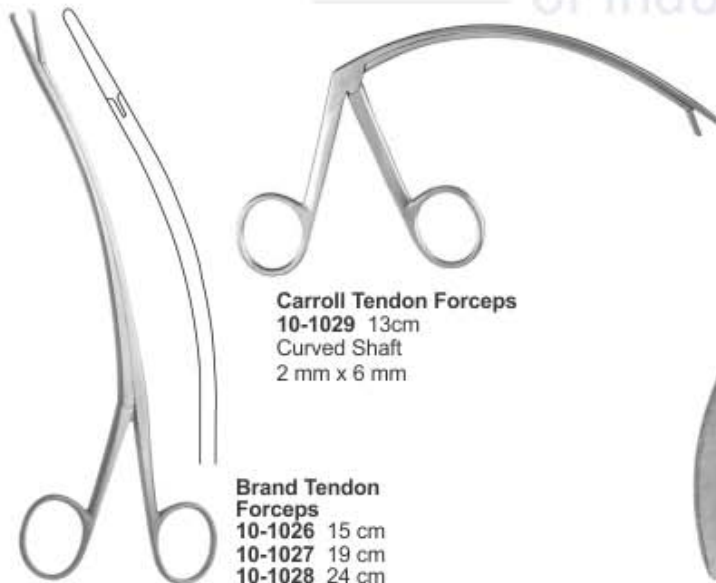

Brand Tendon Forceps 10-1026 15 cm 10-1027 19 cm 10-1028 24 cm

Carroll Tendon Forceps 10-1029 13cm Curved Shaft 2 mm x 6 mm



10-1030 14cm Cross serrated



10-1031 19cm Serrated



Flat Nose Plier 10-1032 18cm

Sehnenstripper, Technische Zangen

enucleadores de tendones, Pinzas técnicas

Instruments a ecorcher les tendons, Pinces techniques

Scollatendini, Pinze tecniche



**Flat Nose Pliers**  
10-1033  
13.5cm  
Broad, 4mm tip,



**Flat Nose Pliers**  
10-1034 16.5cm  
Combination plier and  
cutter



**Needle Nose Pliers**  
10-1035 13.5cm



**Flat Nose Pliers**  
10-1036  
15cm Delicate,  
1.5mm tip



**K-Wire Extraction Pliers  
W/Screw Lock**  
10-1037  
13cm, 3mm tip



**Flat Nose  
K-Wire Pliers**  
10-1038  
14cm  
10-1039  
17cm



**Nose Pliers**  
10-1040  
17cm



**Utility Technical  
Forceps Pliers**  
10-1041 19cm  
adjustable



**Wire Bending  
Forceps**  
10-1042 18.5cm



**Flat Nose Plier**  
10-1043 18.5cm  
parallel grip, incorporated  
cutter, for hard wires up to  
1.6mm

# TECHNICAL FORCEPS

Technische Zangen | Pinzas tecnicas  
Pinces techniques | Pinze tecniche



**Locking Plier**  
10-1044 18cm  
10-1045 20cm  
10-1046 24cm



**Plate Bending Plier**  
10-1047 20cm  
for plates up to 2.7mm  
10-1048 24cm  
for plates up to 4mm



**Locking Plier**  
10-1049 22cm  
10-1050 25cm  
10-1051 30cm  
Locking plier, only  
10-1052 30cm  
with holding pins  
10-1053 46cm  
with extraction device



**Needle-Nose Locking Pliers**  
10-1054



**Needle-Nose Locking Pliers**  
10-1055



**Needle-Nose Locking Pliers**  
10-1056



**Flat Nosed Plier**  
10-1057 18cm  
parallell, with lateral  
wire cutter



**Cast Spreader Model Usa**  
10-1058 23cm  
3 Prong



**Nail Extractor**  
10-1059 16cm  
with Longitudinal Groove  
(for Intramedullary Gliding Nails)

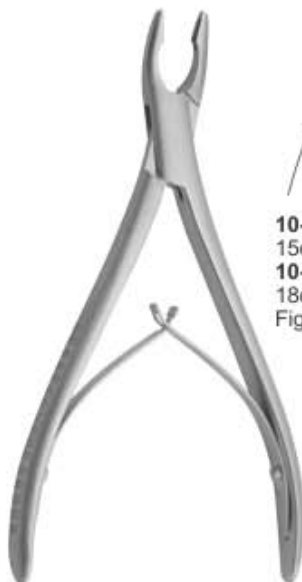

10-1060  
15cm  
10-1061  
18cm  
Fig.1



10-1062  
15cm  
10-1063  
18cm  
Fig.2

**Luer Bone Rongeur**  
Single action  
Curved, 8 x 12mm

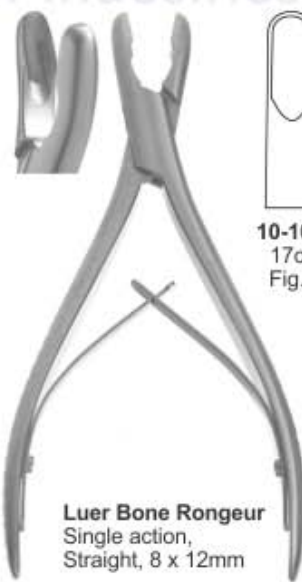

10-1064  
17cm  
Fig. 1



10-1065  
17cm  
Fig. 2

**Luer Bone Rongeur**  
Single action,  
Straight, 8 x 12mm



**Friedmann Bone Rongeur**  
10-1066 14.5cm  
Single action, Curved,  
4 x 11mm

## BONE RONGEURS

Hohlmeißelzangen  
Pinzas gubias

Pinces-gouges  
Pinze-sgorbie



10-1067  
15.5cm  
Fig. 1



10-1068  
15.5cm  
Fig. 2



10-1069  
15.5cm  
Fig. 3

**Blumenthal Bone Rongeur**



10-1070  
18cm  
Fig. 1



10-1071  
18cm  
Fig. 2

**Jasen Bone Rongeur**



**Jansen Bone Rongeur**  
10-1072 19cm



10-1073  
17.5cm  
slightly curved



10-1074  
17.5cm  
Strongly curved

**Stellbrink Bone Rongeur**



10-1075  
15.5cm  
10-1076  
19cm  
Straight



10-1077  
15.5cm  
10-1078  
19cm  
Curved

**Lempert Bone Rongeur**



**Rongeur #4**  
10-1079 14cm  
**Rongeur #4A**  
10-1080 16.5cm  
Single action,  
Curved, 4 x 9mm



**Chichirelli (Blumenthal) Rongeur**  
10-1081 15cm  
Single action, Curved 45°,  
4 x 13mm



**Dean (Blumenthal) Rongeur**  
10-1082 15cm  
Single action,  
Curved 90°, 4 x 11mm



**Dean Rongeur**  
10-1083 14.5cm  
Single action  
Curved, 3mm



Hohlmeißelzangen  
Pinzas gubias

Pinces-gouges  
Pinze-sgorbie



**Hartmann Bone Rongeur**  
10-1084 18.5cm  
Single action  
Curved, 4 x 14mm

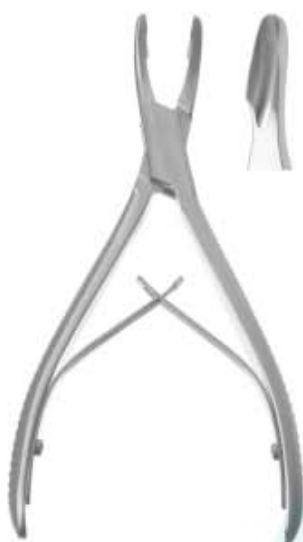

**Mead Bone Rongeur**  
10-1085 16.5cm  
Single action,  
Curved, 5 x 13mm



**Cleveland Bone Rongeur**  
10-1086 14cm  
10-1087 17cm

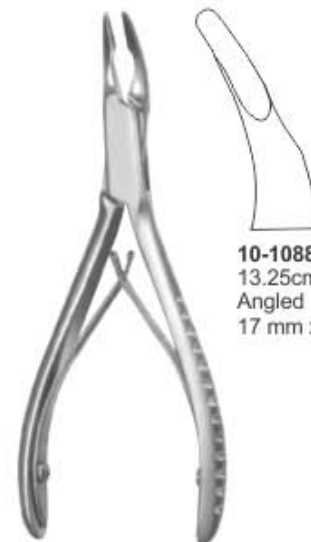

**Universal Bone Rongeur**

10-1088  
13.25cm  
Angled  
17 mm x 3.5 mm



**Bane Bone Rongeur**



10-1089  
18cm  
Single action  
Curved,  
3 x 16mm

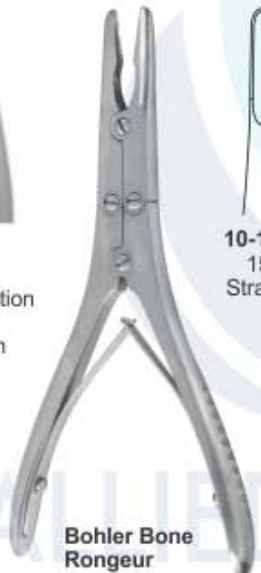

**Bohler Bone Rongeur**



10-1090  
15c  
Straight



10-1091  
15cm  
Curved



**Zaufal-Jansen Bone Rongeur**  
10-1092 18cm  
Double action  
Curved, 5x15mm



**Marquardt Bone Rongeur**  
10-1093 18cm



**Beyer Bone Rongeur**  
18cm  
10-1094 3 x 14mm  
10-1095 4 x 15mm  
Double action, Curved



**Smith-Peterson Laminectomy Rongeur**  
10-1096 24cm  
Double action,  
Straight 3 x 16mm



**Smith-Peterson Laminectomy Rongeur**  
10-1097 24cm  
Double action  
Curved 3 x 16mm

## BONE RONGEURS

Hohlmeißelzangen  
Pinzas gubias

Pinces-gouges  
Pinze-sgorbie



**Ruskin Rongeur**  
10-1098 18cm 4x16mm  
10-1099 18.5cm 5x10mm  
Double action, Curved on side



**Ruskin Rongeur**  
10-1100 18.5cm  
Double action, 6 x 16mm,  
Straight, Curved



**Ruskin Rongeur**  
10-1101 15.5cm Straight, 3.2mm  
10-1102 15cm Curved, 2 x 15mm  
10-1103 15cm Curved, 3 x 15mm  
Double action,



**Riskin Bone Rongeur**



10-1104 15.5cm  
10-1105 18cm  
Double action  
Straight, 2 x 14mm



10-1106 15.5cm  
10-1107 18cm  
Double action  
Curved 2 x 14mm



**Mayfield Bone Rongeur**  
10-1108 18cm



**Stille-Ruskin Bone Rongeur**



10-1109  
23cm  
Curved



10-1110  
23cm  
Straight



**Leksell Bone Rongeur**  
10-1111 24.5cm 5 x 13mm  
10-1112 24cm 8 x 14.5mm  
Double action, Curved 50°



**Leksell Rongeur**  
10-1113 24cm  
6 x 15mm  
10-1114 24cm  
7 x 13mm  
Double action, Curved



**Leksell Rongeur**  
10-1115 24cm  
3 x 18mm  
Double action, Curved



**Leksell Rongeur**  
10-1116 23cm  
4 x 13mm  
Double action  
Fully curved



**Stille Bone Rongeur**



10-1117  
23cm  
4mm



10-1118  
23cm  
6mm



10-1119  
23cm  
8mm



**Stille-Luer Rongeur Forceps**



10-1120  
23cm  
10-1121  
27cm  
straight



10-1122  
23cm  
10-1123  
27cm  
curved



**Echlin Duckbill Bone Rongeur 23cm**

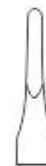

10-1124  
2 x 12mm  
Double action  
Curved on side



10-1125  
3 x 12mm  
Double action  
Curved on side



10-1126  
4.5 x 11mm  
Double action  
Curved on side

# BONE RONGEURS

Hohlmeißelzangen

Pinces-gouges

Pinzas gubias

Pinze-sgorbie



**Stille-Leur Rongeur**  
10-1127 21.5cm  
Curved, Straight  
Double action, 10 x 18mm



**Stille-Leur Rongeur**  
10-1128 26.5cm  
Straight, Curved  
Double action, 10 x 18mm



**Stille-Luer Echlin  
Duckbill Rongeur**  
23cm  
10-1129 6 x 13mm  
10-1130 6 x 15mm  
Double action Curved on side



**Stille-Leur Rongeur**  
10-1131 21.5cm  
Double action  
Curved 10 x 16mm



**Rottgen-Ruskin  
Bone Rongeur**  
10-1132 23cm



**Semb Bone Rongeur**  
10-1133 24cm



**Frykholm Bone Rongeur**  
10-1134 24cm



**Sauerbruch Bone Rongeur**  
30cm



**10-1135**  
Round  
Fig. 1

**10-1136**  
Straight  
Fig. 2



**Luer-Stille Bone Rongeur**  
27cm

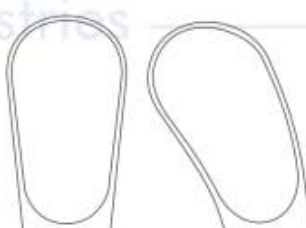

**10-1137**  
Fig. 1

**10-1138**  
Fig. 2



**Leksell-Stille Bone Rongeur**



**10-1139**  
24cm



**10-1140**  
24cm

## BONE RONGEURS

Hohlmeißelzangen  
Pinzas gubias

Pinces-gouges  
Pinze-sgorbie



Leksell Bonerongeur

- 10-1141 25cm 3 x 16mm
- 10-1142 23cm 5 x 16mm
- 10-1143 25cm 4.5 x 16mm
- 10-1144 25cm 6 x 16mm
- 10-1145 25cm 7 x 16mm
- 10-1146 25cm 8 x 16mm
- Double action, Curved 15°



Hakansson Bone Rongeur  
10-1147 20cm



Kleinert-Kutz Bone Rongeur

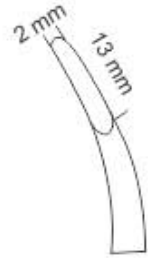

10-1148  
15.25cm  
2 x 13 mm



Ruskin-Mini Bone Rongeur

10-1149  
15.25cm  
Curved  
18 x 5 mm



- Syfert Rongeur
- 10-1150 35.5cm 4 x 16mm
  - 10-1151 35.5cm 8 x 16mm
  - 10-1152 35.5cm 12 x 16mm
  - 10-1153 37cm 5 x 16mm
  - Double action, Angled



Cottle-Kazanjian Bone  
Cutting Rongeur Forceps  
10-1154 19cm



Littauer / Liston Bone  
Cutting Rongeur Forceps

10-1155  
15cm  
Straight,



Cleveland Bone Cutting  
Rongeur Forceps

10-1156  
15cm  
curved

10-1157  
17cm  
curved



Liston Bone Cutting  
Rongeur Forceps



10-1158  
14cm  
Angled



10-1159  
17cm  
Angled



10-1160  
19cm  
Angled



10-1161  
22cm  
Angled

# BONE CUTTING FORCEPS

*Knochen splitter zangen*  
*Pinces coupantes a os*

*Pinzas cortantes para huesos*  
*Cesoie per ossa*



10-1162 14 cm  
10-1163 17 cm  
10-1164 19 cm  
10-1165 20 cm  
10-1166 22 cm  
Straight

**Liston Bone Cutting Rongeur Forceps**



10-1167  
27 cm  
Straight

10-1168  
27 cm  
Angled 45°

10-1169  
27 cm  
Angled 90°

**Stille-Liston Bone Cutting Rongeur Forceps**



**Semb Bone Cutting Rongeur Forceps**  
10-1170 24cm



**Liston Key Horsley Bone Cutting Rongeur Forceps**  
10-1171 27cm



**Horsley Bone Cutting Rongeur Forceps** 10-1172 25cm



**Ruskin Bone Cutting Rongeur Forceps**  
10-1173 20cm  
Double-Action

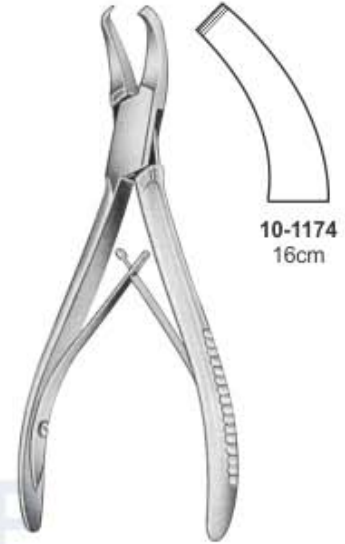

10-1174  
16cm

**Cleveland-Gardner Bone Cutting Rongeur Forceps**

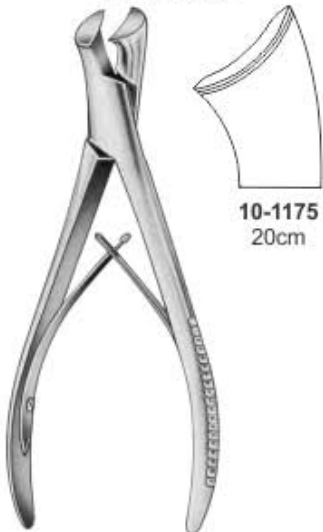

10-1175  
20cm

**Markwalder Bone Cutting Rongeur Forceps**

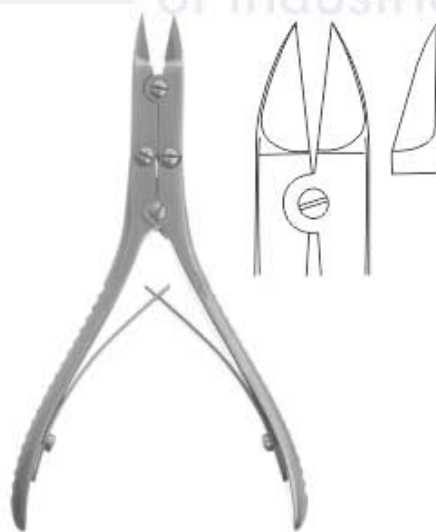

**Bone Cutting Rongeur Forceps**  
10-1176 15cm

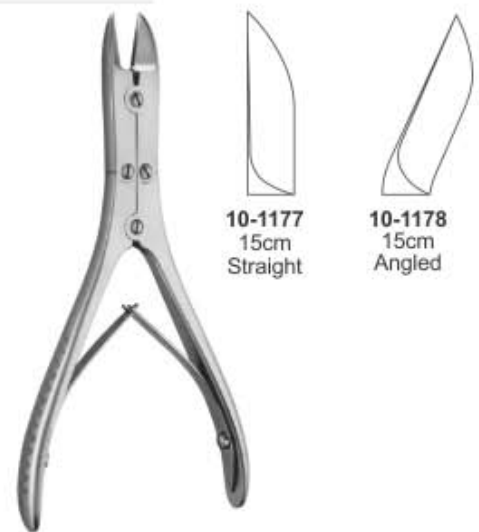

10-1177  
15cm  
Straight

10-1178  
15cm  
Angled

**Bohler Bone Cutting Rongeur Forceps**

## BONE CUTTING FORCEPS

Knochensplitterzangen  
Pincas coupantes a os

Pinzas cortantes para huesos  
Cesoie per ossa

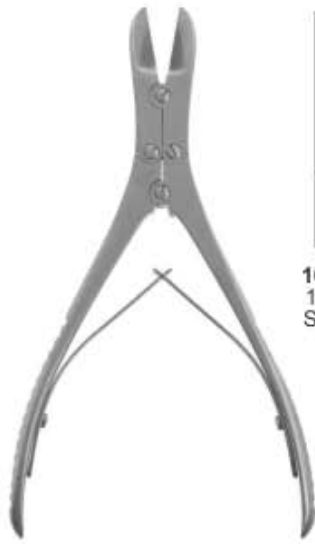

10-1179  
18.5cm  
Straight



10-1180  
18.5cm  
Angled



10-1181  
15cm  
Straight



10-1182  
15cm  
Angled



10-1183 Straight  
10-1184 Curved  
10-1185 Angled  
19cm deicate

Ruskin-Liston Bone Cutting Rongeur Forceps

Walton-Liston Bone Cutting Rongeur Forceps

Ruskin-Liston Bone Cutting Rongeur Forceps



10-1186  
17.5cm  
Straight



10-1187  
17.5cm  
Curved



Mc Indoe Bone Cutting Rongeur Forceps

Mc Indoe Bone Cutting Forceps  
10-1188 18cm  
Angled, delicate,

Kleinert-Kutz Bone Cutting Forceps  
10-1189 15cm  
Straight, delicate,

Kleinert-Kutz Synovectomy Rongeur  
10-1190 15cm 2 x 10mm  
Double action,  
Curved on side, delicate,



10-1191  
27cm  
Straight



10-1193  
23cm  
Angled



10-1194  
27cm  
Angled

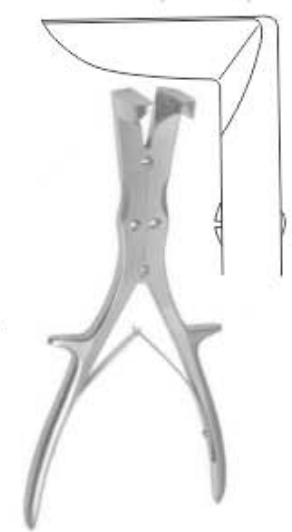

Stille-Liston Bone Cutting Rongeur Forceps

Stille-Horsley Bone Cutting Forceps  
10-1192 24cm

Liston Bone Cutting Rongeur Forceps

Liston-Stillle Bone Cutting Rongeur Forceps  
10-1195 26cm

# WIRE CUTTING INSTRUMENTS

*Drahtschneidezangen*  
*Pinces coupantes*

*Alicates para cortar alambre*  
*Pinze taglia Filo*

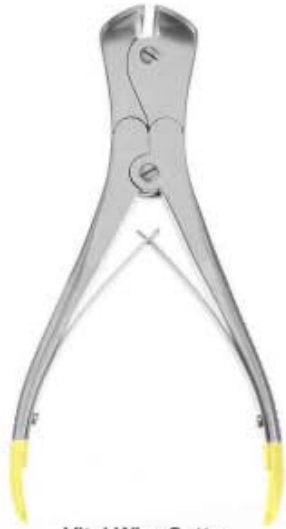

**Vital Wire Cutter**  
**10-1196** 22cm  
for hard wires up to 2.2mm,  
for soft wires up to 3mm



**Vital Wire Cutter**  
**10-1197** 22cm  
for hard wires up to 2.2mm,  
for soft wires up to 2.8mm



**Vital Wire Cutter**  
**10-1198** 23cm  
for hard wires up to 2.2mm,  
for soft wires up to 3mm



**Vital Wire Cutter**  
**10-1199** 18cm  
for hard wires up to 1.5mm,  
for soft wires up to 2mm



**Pin Puller W/  
Groove TC**  
**10-1200** 14cm



**Vital Wire Cutter**  
**10-1201** 18cm  
for hard wires up to 1.7mm,  
for soft wires up to 2mm



**Vital Wire Cutter**  
**10-1202** 15cm  
for hard wires up to 1mm,  
for soft wires up to 1.5mm



**Vital Wire Cutter**  
**10-1203** 14.5cm  
for hard wires up to 1mm,  
for soft wires up to 1mm



**Cannulated Wire  
/ Pin Cutter**  
**10-1204** 19cm  
Cuts wire upto 1.6 mm



**Hard Wire Cutter Cuts**  
**10-1205** 26cm  
for hard wires up to 3mm



**Kirschner Wires &  
Steinmann  
Pins Cutter**  
**10-1206** 57cm  
up to 6mm



**Side Pin Cutter**  
**10-1207**  
57.5cm  
Side cutting w/  
carbide inserts  
max. cap: 5/32"



**Vital Heavy  
Duty Pliers TC**  
**10-1208**  
22cm  
Grip Forceps,  
Combined  
with cutter



**Vital Wire  
Extraction  
Pliers T.C**  
**10-1209** 5mm  
**10-1210** 7mm  
18cm



**Side Cutter**  
10-1211 18.5cm  
Welded carbide jaws  
max capacity. 1.6mm



**Delicate Wire Cutter**  
10-1212 12.5cm  
Side cutting w/ carbide inserts  
max capacity. 0.7mm



**Front & Side Wire Cutter**  
10-1213 17cm  
Front and side cutting w/ carbide inserts,  
double action. Max capacity. 1.6mm



**Double Action Wire Cutter**  
Angled, Side cutting w/  
carbide inserts  
10-1214 17cm  
max cap 1.6mm  
10-1215 21.5cm  
max cap. 2.4mm



**Flush Wire Cutter**  
10-1216 17cm  
Front and side cutting w/ carbide inserts,  
double action. Max capacity. 1.5mm



**Wire Forceps**  
10-1217 17cm  
Straight, serrated 5.4 mm tip



**Pin Cutter Small**  
10-1218 26cm  
Max cap: 3.2mm



**Pin Cutter Medium**  
10-1219 36.5cm  
Max cap: 4.7mm



**Large Pin Cutter**  
10-1220 57.5cm  
Large, Straight, Max.  
capacity 6.3mm



**Stille Plaster Shear**  
10-1221 37cm



**Schumacher Sternum  
Shears**  
10-1222 21cm



## BONE HOLDING CLAMPS - BONE HOLDING FORCEPS

Knochenhalteklammern - Knochenhaltezangen | Pinzas porta huesos - Pinzas para huesos  
 Daviers a os - Daviers porte-so | Tenaglie per ossa



**Gerster-Lowmann Bone Clamp**  
 10-1223 12cm  
 10-1224 14.5cm  
 10-1225 18cm, 28mm  
 10-1226 20cm, 35mm  
 10-1227 22cm, 40mm  
 1x2 Jaws



**Lowmann Bone Clamp**  
 10-1228 12cm  
 10-1229 15cm  
 10-1230 17cm  
 10-1231 18.5cm  
 10-1232 20cm



**Lambert-Lowman Bone Clamp**  
 10-1233 17.5cm  
 10-1234 20.3cm  
 2x2 Jaws

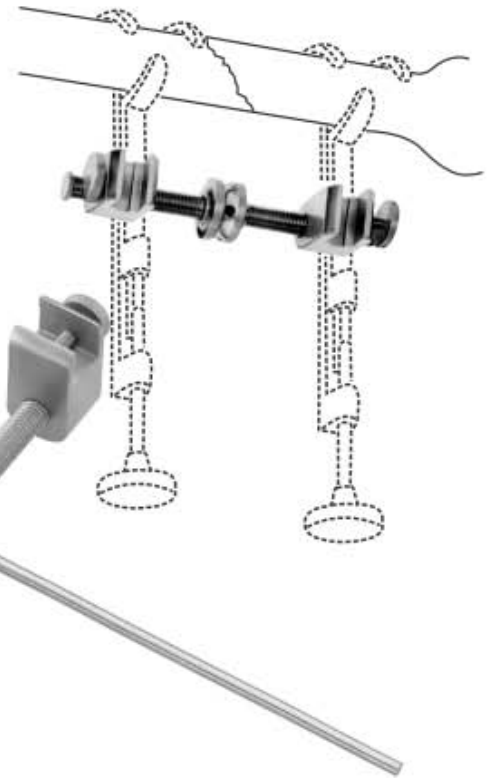

**Gerster Bone Holding Clamp**  
 10-1235 15cm

ALLIED GROUP  
 of Industries



**Gerster Bone Holding Clamp**  
 10-1236



**Gerster Bone Holding Clamp**  
 10-1237



**Parham-Martin Bone Clamp**  
 10-1238 21cm  
 Straight



**Parham Martin Bands**  
 10-1239 19cm

Knochenhaltezaugen - Repositionszaugen  
Daviers porte-so-pinces de reposition

Pinzas para huesos - pinzas para reposicion  
Tenaglie per ossa - Pinze per riposizioni



**Bone Reduction Forceps**  
10-1240 13.5cm



**Locke Phalangeal Forceps**  
10-1241 14cm



**Lewin Perforating Bone Holding Forceps**

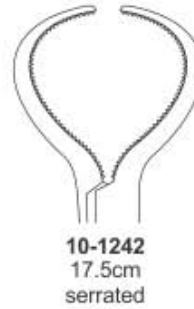

**Stagbeetle Bone Reduction Forceps**  
10-1243 Pointed tips, 13cm



10-1244  
13.5cm  
Angled  
Serrated

**Bone Reduction Orthopedic Forceps**



**Shoulder Percussion Awl**  
Pointed, 21.6cm  
10-1245 Small  
10-1246 Medium  
10-1247 Large  
10-1248 Pointed, 23.5cm



**Meniscus Clamp**  
10-1249 13.5cm  
Serrated



**Meniscus Clamp**  
10-1250 13.5cm  
Angled 20°, serrated



**Preston Logamentum Flavum Forceps**  
10-1251 19cm  
Curved, 1 x 2 teeth



**Meniscus Clamp**  
10-1252 18cm  
Straight, Curved shaft



**Dingman Bone Clamp**  
10-1253 19cm  
Straight, Serrated,  
1 1/2" tip length, Curved shaft

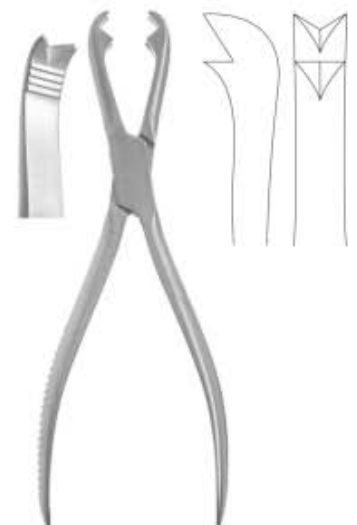

**Fergusson Bone Holding Forceps**  
10-1254 21cm 2 x 2 teeth

# BONE HOLDING FORCEPS

Knochenhaltezaugen

Pinzas para huesos

Daviers porte-os

Tenaglie per ossa



10-1255  
23cm

**Van Buren Sequestrum Forceps**  
Curved on side, serrated



**Langenbeck Bone Holding Forceps**  
10-1256 21cm



**Semb Bone Holding Forceps**  
10-1257 19cm without ratchet  
curved sideways deep teeth

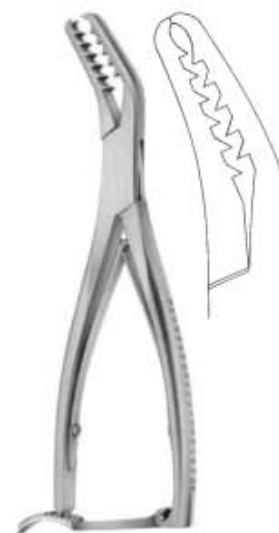

**Semb Bone Holding Forceps**  
10-1258 20.3cm, with ratchet  
curved sideways deep teeth



10-1259  
17.8cm  
10-1260  
20cm  
10-1261  
23cm  
straight

**Sequestrum (Nircosis) Bone Holding Forceps**



10-1262  
17.8cm  
10-1263  
20cm  
10-1264  
23cm  
angled on flat



10-1265  
23cm  
10-1266  
26cm

**Farabeuf Bone Holding Forceps**  
with adjustable jaw



10-1267  
26cm

**Farabeuf-Lambotte Bone Holding Forceps**  
with adjustable jaw

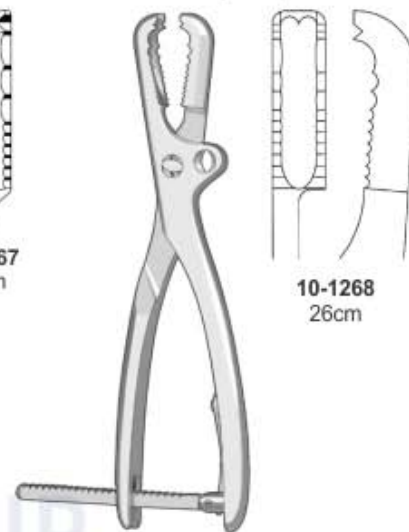

10-1268  
26cm

**Farabeuf-Lambotte Bone Holding Forceps**  
with adjustable jaw



**Bishop Bone Clamp**  
10-1269 22.5cm  
Straight



**Kern Bone Holding Forceps**  
10-1270 17cm  
10-1271 24cm  
without ratchet



**Kern Bone Holding Forceps**  
10-1272 17cm  
10-1273 24cm  
with ratchet



**Hey Groves Bone Holding Forceps**

## BONE HOLDING FORCEPS

Knochenhaltezaugen

Pinzas para huesos

Daviers porte-os

Tenaglie per ossa



- 10-1277  
33cm 11 mm tip W/ Ratchet
- 10-1278  
33cm 13 mm tip W/ Ratchet
- 10-1279  
43cm 13.5 mm tip W/ Ratchet
- 10-1280  
13cm 10 mm tip W/o Ratchet

**Lane Bone Holding Forceps**  
Light Model



**Lane Bone Holding Forceps**  
10-1281 33cm 13 mm tip  
10-1282 43cm 12 mm tip  
without ratchet



**Ulrich Bone Holding Self Retaining Forceps**

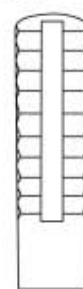

- 10-1283 18 cm mini
- 10-1284 22 cm
- 10-1285 26 cm
- 10-1286 28 cm
- Straight with speed lock



- 10-1287 18cm
- 10-1288 22cm
- 10-1289 26cm
- 10-1290 28cm
- Angular, with speed lock

**Ulrich Bone Holding Forceps**



- 10-1291  
28cm

**Ulrich Bone Holding Forceps**  
Angular With Speed Lock  
& swivel jaw



- 10-1292  
22cm
- 10-1293  
27cm
- 10-1294  
30cm

**Lambotte Bone Holding Forceps**  
One Jaw Mobile  
adjustable jaw



**Lane Bone Holding Forceps**  
10-1295 31.5cm  
10-1296 39cm



- 10-1297  
15 cm, 2.5mm
- 10-1298  
19 cm, 6.5mm
- 10-1299  
24 cm, 9.5mm
- 10-1300  
26 cm, 10mm
- 10-1301  
28 cm, 11mm

**Lambotte Bone Holding Forceps**  
Self-Centering, with speed lock



**Subacromion Spreader**  
10-1302 26.75cm Right  
10-1303 26.75cm Left



**Bone Reduction Forceps**  
10-1304 14cm  
Serrated with pointed tips

# BONE HOLDING FORCEPS

Knochenhaltezaugen

Pinzas para huesos

Daviers porte-os

Tenaglie per ossa



**Bone Reduction Forceps**  
10-1305 14cm Curved  
10-1306 15cm Serrated



10-1307  
14cm Serrated  
10-1308  
14cm Curved  
10-1309  
17cm Curved

**Bone Reduction Forceps,  
Pointed Tips**



**Semb Bone Holding Forceps**  
Curved on side  
10-1310 19cm 4 x 5 teeth  
10-1311 21cm 5 x 5 teeth



**Martin Cartilage Bone Holding  
Clamp Forceps**  
10-1312 19 cm Str.



10-1313  
20cm  
Str.

**Bircher-Ganske  
Bone Holding Forceps**



10-1314  
20cm  
Cvd.



10-1315  
17.5cm  
5.0mm

**Verbrugge Bone  
Holding Forceps**

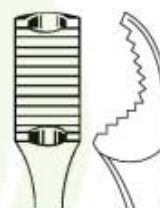

10-1316  
25cm  
9.5mm



10-1317  
26cm  
10.5mm



10-1318  
27cm  
12.0mm

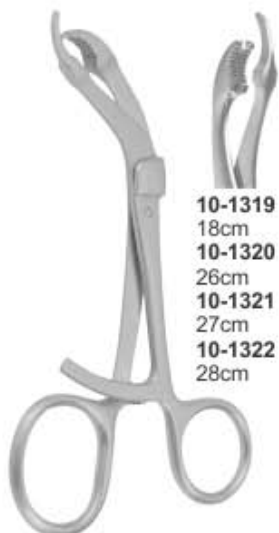

10-1319 18cm  
10-1320 26cm  
10-1321 27cm  
10-1322 28cm

**Verbrugge Bone  
Holding Forceps  
W/ Long Ratchet**

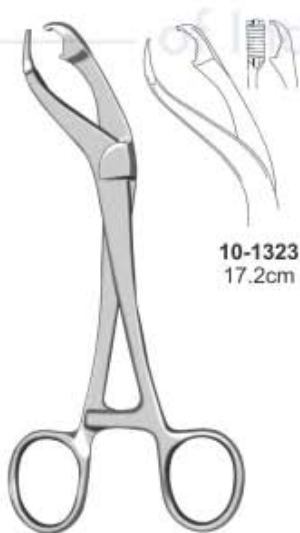

10-1323  
17.2cm

**Verbrugge Bone Holding  
Forceps  
with short ratchet**



10-1324 15 cm  
10-1325 19 cm  
10-1326 24 cm  
10-1327 26 cm  
10-1328 29 cm

**Verbrugge Self-Centering  
Bone Holding Forceps  
with long ratchet**



**Lane Bone Plate Holding  
Forceps**  
10-1329 22cm

## BONE HOLDING FORCEPS

Knochenhaltezaugen  
Daviers porte-so

Pinzas para huesos  
Tenaglie per ossa



**Verbrugge Bone Holding Forceps**  
10-1330 18cm



**Verbrugge Bone Holding Forceps**  
10-1331 18cm



10-1332  
25cm  
10-1333  
26cm  
10-1334  
27cm

**Verbrugge Bone Holding Forceps**

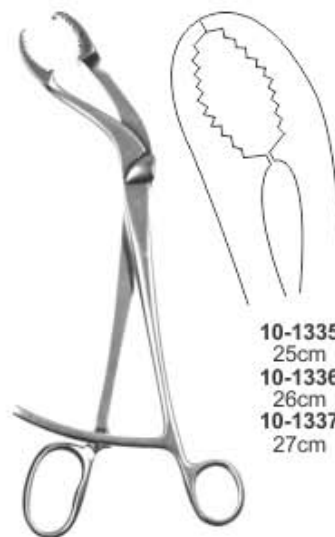

10-1335  
25cm  
10-1336  
26cm  
10-1337  
27cm

**Verbrugge Bone Holding Forceps**



**Verbrugge Bone Holding Forceps**  
10-1338 18cm



10-1339  
25cm  
10-1340  
26cm  
10-1341  
27cm

**Verbrugge Bone Holding Forceps**



**Bone Reduction Forceps**  
10-1342 13.5cm



**Reill Bone Reduction Forceps**  
10-1343 17cm  
Curved, pointed tips



**Bone Reduction Forceps**  
10-1344 20.4cm  
Pointed tips



**Bone Reduction Forceps**  
10-1345 13.5cm  
for maxillary reposition



**Haase**  
10-1346 16.5cm  
for mandibular fractures



10-1347  
9.5cm

10-1348  
9.5cm

**Bone Holding forceps**

# BONE HOLDING FORCEPS

Knochenhaltezaugen  
Daviers porte-so

Pinzas para huesos  
Tenaglie per ossa



**Fibula Bone Holding Forceps**  
10-1349 22cm



**Glenoid Perforating Forceps**  
10-1350 17cm  
Lightly curved, pointed tips  
Strongly curved, pointed tips



**Reil Bone Holding Forceps**  
10-1351 17cm



**Bone Reduction Forceps with Points**  
10-1352 20cm



**Pelvic Reduction Forceps Asymmetric**  
10-1353 40cm



**Malleolar Bone Holding Forceps**  
10-1354 21cm  
Straight, 1 x 1 teeth



**Patella Malleolar Forceps**  
10-1355 21cm



**Reduction Forceps with Thread Lock**

10-1356 16cm  
10-1357 24cm



**Reposition Forceps**  
10-1358 23cm

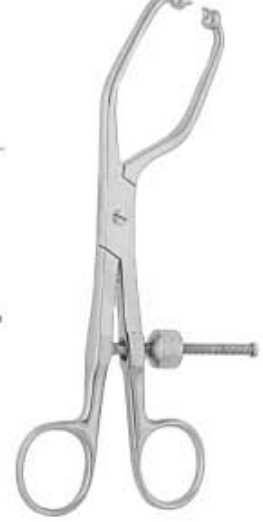

**Pelvic Reposition Forceps**  
10-1359 19cm  
10-1360 23cm



**Pelvic Reposition Forceps**  
10-1361 25cm



**Pelvic Reposition Forceps 3 Balls Spikes**  
10-1362 25cm



**Pelvic Reduction Forceps Asymmetric with 3 ball Spikes**  
10-1363 25cm



**Pelvic Reduction Forceps Asymmetric**  
10-1364 25cm



**Pelvic Reposition Forceps**  
10-1365 40cm



**Pelvic Reposition Forceps**  
10-1366 40cm

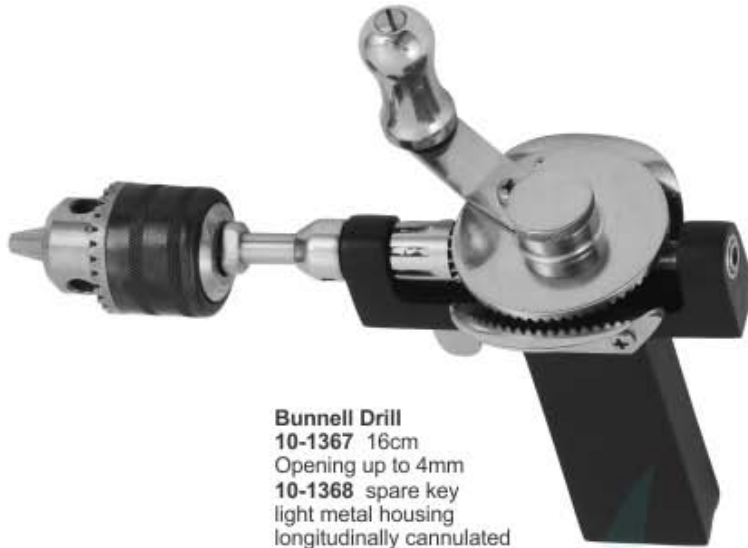

**Bunnell Drill**  
10-1367 16cm  
Opening up to 4mm  
10-1368 spare key  
light metal housing  
longitudinally cannulated



**Ralk Drill**  
10-1369 16cm  
Opening up to 6.35mm  
light metal housing  
longitudinally cannulated



10-1372



**Plaster Saw Electronic Power**  
Volt #110  
10-1370

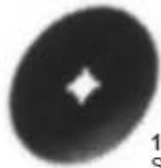

10-1373  
Spare Blade

Volt #220  
10-1371



**Moore Drill And Bit Set Complete**  
10-1374

ALLIED GROUP  
of Industries



Fig. 1	Fig. 2	Fig. 3	Fig. 4	Fig. 5	Fig. 6	Fig. 7	Fig. 8	Fig. 09	Fig. 10	Fig. 11	Fig. 12
10-1376	10-1377	10-1378	10-1379	10-1380	10-1381	10-1382	10-1383	10-1384	10-1385	10-1386	10-1387
2.5mm	3.0mm	3.5mm	4.0mm	5.0mm	8.0mm	12.0mm	16.0mm		1.0mm	1.5mm	2.0mm

**Stille Pattern Drill Set**  
10-1375  
Complete set of stainless  
drill bits and burrs



# HAND DRILLS

Handbohrapparate  
Perforateurs a main

Perforadores de mano  
Perforatori a mano



10-1388  
Hudson Brace 26.7cm  
with standard thumb screw chuck

10-1389  
Hudson Brace 27.9cm  
with Improved Snap-Lock chuck

- C 10-1390 Hudson Bur, 9mm Diameter
- D 10-1391 Hudson Bur, 14mm Diameter
- E 10-1392 Hudson Bur, 16mm Diameter
- F 10-1393 Hudson Bur, 22mm Diameter
- G 10-1394 Cushing Perforator, for Hudson Brace
- H 10-1395 Hudson Cerabellar Extension, 4" for Hudson Brace
- I 10-1396 McKenzie Perforator for Hudson Brace



Jacobs  
10-1397 28cm  
opening up to 6.35mm



Hand Drill  
10-1398  
opening up  
to 6.35mm



T-Handle  
10-1399  
AO Coupling



Jacob's Chuck  
10-1400 T-Handle and key  
10-1401 only  
10-1402 Key



Key Handle  
10-1403



T-Handle  
10-1404  
for AO Coupling



Memoral Head Extractor  
10-1405

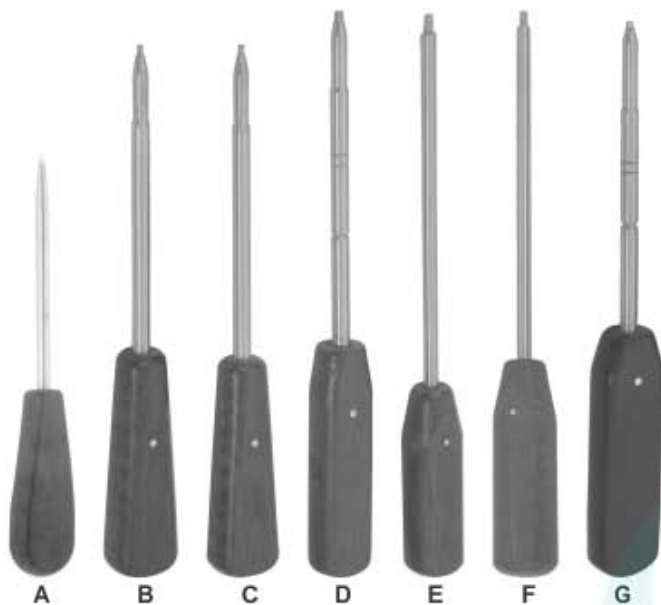

### HEXAGONAL HEAD

	Size of screws	Head Size	Fiber-Handle	AO Coupling	Dental Coupling
A	1.5mm	1.5mm	10-1406	10-1409	10-1412
B	2.0mm				
C	2.7mm	2.5mm	10-1407	10-1410	
D	3.5mm				
E	4.0mm				
F	4.5mm	3.5mm	10-1408	10-1411	
G	6.5mm				



**Parallel Target Device 10-1413**  
for guide wires 2mm



**Mortising Chisel 10-1414**



**Wire Guide 10-1415**  
45mm



**Wire Guide 10-1416**  
70mm



**Countersink 10-1417**



**Countersink 10-1418**



**Countersink 10-1419**



**Perthes 10-1420** 18cm  
**10-1421** 21cm



**10-1422**  
14cm



**10-1423**  
14cm



**Mini Drill Sleeve 10-1424**  
1.1 mm and 1.5 mm drill bits  
**10-1425**  
1.5 mm and 2.0 mm drill bits

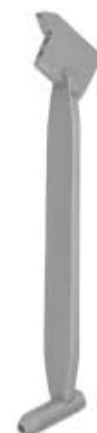

**Drill Guide 10-1426**  
drill sleeve for 2.0 mm drill bit



**10-1427** Tap Sleeve, 2.0 mm  $\phi$   
**10-1428** Drill Sleeve, 2.7 mm  $\phi$   
**10-1429** Tap Sleeve, 2.5 mm  $\phi$   
**10-1430** Drill Sleeve, 3.5 mm  $\phi$



**Neutral & Load Drill Guide**  
**10-1431** 1.5 mm for 2.0 mm Screws  
**10-1432** 2.0 mm for 2.7 mm Screws  
**10-1433** 2.5 mm for 3.5 mm Screws  
**10-1434** 3.2 mm for 4.5 mm Screws



**Tap Sleeve**  
**10-1435**  
 3.5 mm



**Tap Sleeve**  
**10-1436**  
 3.5 mm also for used  
 as 3.2 mm drill Guide



**Tap Sleeve**  
**10-1437**  
 4.5 mm



**Drill Sleeve**  
**10-1438** 3.2 mm  
 for Round Hole Plates



**Drill Guide**  
**10-1439** 4.5 mm Screws  
 Drill Bit 4.5 mm & 3.2 mm



**Drill Guide**  
**10-1440** 6.5 mm Screws  
 Drill Bit 3.2 mm



**Drill Guide**  
**10-1441** 3.5 mm for neutral and  
 compression Positioning Drill Bit 2.5 mm



**C - Clamp**  
**10-1442**  
 Drill Guide with thread  
 for Drill Bit 4.5 mm



**Insert Drill Sleeve**  
**10-1443** 2.7 / 2.0 mm Drill Bit 2.0 mm  
**10-1444** 3.5 / 2.5 mm Drill Bit 2.5 mm  
**10-1445** 4.5 / 3.2 mm Drill Bit 3.2 mm



**Drill Small Pointed**  
**10-1446** Drill Bit 3.5 mm



**Drill Pointed Guide**  
**10-1447** 6.5 mm



**Drill Pointed Guide**  
**10-1448** 6.5 mm



**Bending Device  
10-1449**  
21.5cm  
to bend straight  
and angled plates



**Bending Device  
10-1450**  
21.5cm  
to bend straight  
and angled plates



**Rod Bender  
10-1451**  
to bend straight  
and angled



**Universal Rod Bender  
10-1452** 28.5cm  
to bend straight  
and angled



**Rod Bender  
10-1453**  
to bend straight  
and angled



**Slotted Hammer  
10-1454** 14mm



**Plate Bender  
10-1455**



**Plate Bender  
10-1456**



**Plate Bender  
10-1457**



**Plate Bender  
10-1458**



**Plate Bender  
10-1459**



**Plate Bender  
10-1460**



**Plate Bender  
10-1461**

## EXTENSION BOWS

Extensionsbugel  
Etriers pour extension

Estribos para extension  
Archi per estensione



**10-1462** 18cm  
Wire strainer for  
kirschner wires



**Kirschner Extension Bows**  
**10-1463** x=95mm y=70mm  
**10-1464** x=100mm y=100mm  
**10-1465** x=120mm y=120mm  
**10-1466** x=155mm y=155mm  
**10-1467** x=200mm y=155mm  
 with 3 traction hooks



**Kirschner Extension Bows**  
**10-1468** x=130mm  
**10-1469** x=185mm  
**10-1470** x=220mm  
 with 3 traction hooks



**Wrench  
Kirschner  
Extension Bows**  
**10-1471**  
 14mm/17mm



**Kirschner Extension Bows**  
**10-1472** x=180mm y=100mm  
**10-1473** x=270mm y=160mm  
 with 3 traction hooks



**Bohler Kirschner Extension Bows**  
**10-1474** x=75mm y=90mm  
**10-1475** x=90mm y=160mm  
**10-1476** x=110mm y=210mm  
**10-1477** x=150mm y=210mm  
 with 3 traction hooks



**Charnley-mueller**  
**10-1478**  
 Compression Clamp



**Screw Depth Gauges**

- 10-1479 Mini Gauge, Longmeasures up to 30mm
- 10-1480 Small Gauge, Longmeasures up to 50mm
- 10-1481 Large Gauge, Longmeasures up to 100mm
- 10-1482 X-Large Gauge, Longmeasures up to 120mm



**Screw Depth Gauges**

- 10-1483 Mini Gauge, Longmeasures up to 30mm
- 10-1484 Small Gauge, Longmeasures up to 50mm
- 10-1485 Large Gauge, Longmeasures up to 100mm
- 10-1486 X-Large Gauge, Longmeasures up to 120mm



**Measuring Gauge  
10-1487  
for nail**

**10-1488 Tri Angular Positioning Plate**

