

TROCARS, SUCTION TUBES, NEEDLE AND PROBES





Cap Only



Fig. 1 02-03 1.7 mm Ø
Fig. 2 02-04 3 mm Ø
Fig. 3 02-05 4.5 mm Ø
Fig. 4 02-06 6 mm Ø



Fig. 1 02-09 1.7 mm Ø
Fig. 2 02-10 3 mm Ø
Fig. 3 02-11 4.5 mm Ø
Fig. 4 02-12 6 mm Ø

Universal Abdominal Trocar Set 02-01
(Handle with 4 needles) 14 cm
Fig. 1.7 mm Ø to 6 mm Ø
02-02
Only Handle

Universal Abdominal Trocar Set 02-07
(Handle with 4 needles) 14 cm
Fig. 1.7 mm Ø to 6 mm Ø
02-08
Only Handle



Luer, Trocar 02-13
Luer Lock Adapter

Uckermann Trocar 02-14 13cm

Sinuscopy Trocar 17cm

Nelson Trocar Thorax 21cm

02-18 6.0mmØ

02-19 8.3mmØ

02-20 9.5mmØ

02-21 11.6mmØ

TROCARS

Trokare | Trócares
Trocart | Trequarti



Lichtwitz
Antrum Trocar
19 cm



Complete
02-22
1.8mm Ø
02-23
2.0mm Ø



Landau, Trocar
02-24 2.0mmØ
16cm



Ochsner
Trocar Thorax
10cm

- 02-25** 3 1/3 mm Ø
- 02-26** 4 mm Ø
- 02-27** 4 2/3 mm Ø
- 02-28** 5 1/3 mm Ø
- 02-29** 6 mm Ø
- 02-30** 6 2/3 mm Ø
- 02-31** 7 1/3 mm Ø
- 02-32** 8 mm Ø
- 02-33** 8 2/3 mm Ø
- 02-34** 9 1/3 mm Ø



Pierce
Antrum Trocar
17cm

- 02-35**
3.0mm Ø
- 02-36**
4.0mm Ø
- 02-37**
5.0mm Ø



Krause, Trocar
02-38 15cm
5.5mm Ø



Coakley, Trocar
02-39 16cm
2.25mm Ø

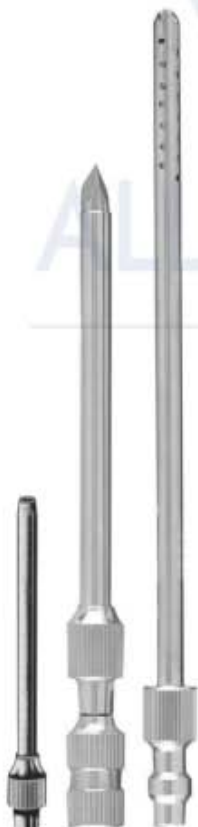

Duke Trocar
02-40 11cm
5.5mmØ



Douglas Trocar
02-41 12cm
3mm



Trocar
02-42
11 cm



Birch Trocar
02-43 18cm
4.5mm



Trocar
02-44

TROCARS

Trokare | Trócares
Trocarts | Trequarti



Buelau, Trocar
02-45 8 mm
24 cm



Fleurant Trocar
02-46 23cm
5 mm Ø



Fleurant Trocar
02-47 23cm
5mm Ø



Fleurant Trocar
02-48 23cm
5 mm Ø



Pool
02-49 22.5 cm
Suction cannula with
outer tube to be screwed

SUCTION TUBES

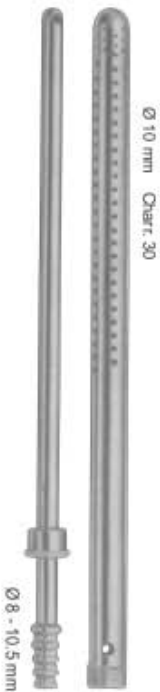

Pool
02-50 22.5 cm
Suction cannula with
outer tube to be screwed



02-51 18 cm
for tonsillectomy,
oral and laryngeal
operations



02-52 22 cm
Suction Cannula for
tonsillectomy, oral
and laryngeal operations





02-53 18 cm
suction cannula for
tonsillectomy, oral
and laryngeal operations



02-54 17 cm
S-shaped blunt cannula
for aspirating fluid from
the excretory ducts of
large glands and for
keeping the operations
area clear

SUCTION TUBES

Saugrohre | Tubos de aspiracion
 Canules d'aspiration | Tubi per aspirazione

				
<p>Cooley, Suction Tube 02-55 18 cm 6mm Ø</p>	<p>Cooley, Suction Tube 02-56 18 cm 7mm Ø</p>	<p>Cooley, Suction Tube 02-57 18 cm 09mm Ø</p>	<p>Cooley, Suction Tube 02-58 32.7 cm 9mm Ø Curved</p>	<p>Andrews-Pynchon Suction Tube 02-59 23.5 cm</p>
				
<p>Yankauer Suction Tube 02-62 31 cm, 15 cm 2.5 cm, 10 cm</p>	<p>Yankauer Suction Tube 02-63 31 cm, 15 cm 2.5 cm, 10 cm</p>	<p>De Bakey suction tube 02-64 27.5 cm</p>	<p>Yankauer Suction Tube 02-65 27 cm Baby Yankauer 02-66 21 cm</p>	<p>Coupland Suction Tube 02-67</p>
				
<p>Adson suction tubes 02-71 4 mm Ø 15 cm</p>	<p>Adson suction tubes 21 cm 02-72 4 mm Ø 12 Charr./Fr 02-73 5 mm Ø 15 Charr./Fr</p>	<p>02-74 Wullstein Suction Tube Complete</p>	<p>Gorney Suction Tubes 02-75 18 cm suction dissector</p>	<p>Byrd, Suction Tube 02-68 1.5 mm 02-69 2.5mm 02-70 3.5 mm</p>
<p>Adson suction tubes 02-71 4 mm Ø 15 cm</p>	<p>Adson suction tubes 21 cm 02-72 4 mm Ø 12 Charr./Fr 02-73 5 mm Ø 15 Charr./Fr</p>	<p>02-74 Wullstein Suction Tube Complete</p>	<p>Gorney Suction Tubes 02-75 18 cm suction dissector</p>	<p>Landolt Dissecting Suction Tubes 02-76 4 mm wide 02-77 5 mm wide 20 cm suction raspatories, sharp,</p>

SUCTION TUBES

Saugrohre | Tubos de aspiración
Canules d'aspiration | Tubi per aspirazione



Plester Daumenplatt
02-79 6 Charr./Fr.
02-80 7 Charr./Fr.
02-81 8 Charr./Fr.
02-82 9 Charr./Fr.
02-83 10 Charr./Fr.
02-84 11 Charr./Fr.
02-85 12 Charr./Fr.
02-86 15 Charr./Fr.

Baron suction tubes 7.5 cm
02-87 1 mm Ø 3 Charr./Fr.
02-88 1 2/3 mm Ø 5 Charr./Fr.
02-89 2 1/3 mm Ø 7 Charr./Fr.

Baron suction tubes 10 cm
02-90 1 mm Ø 3 Charr./Fr.
02-91 1 2/3 mm Ø 5 Charr./Fr.
02-92 2 1/3 mm Ø 7 Charr./Fr.

House suction tubes 7.5 cm
02-93 1 mm Ø 3 Charr./Fr.
02-94 1 2/3 mm Ø 5 Charr./Fr.
02-95 2 1/3 mm Ø 7 Charr./Fr.
02-96 2 2/3 mm Ø 8 Charr./Fr.
02-97 3 1/3 mm Ø 10 Charr./Fr.
02-98 4 mm Ø 12 Charr./Fr.
02-99 4 2/3 mm Ø 14 Charr./Fr.

House suction tubes 10 cm
02-100 1 mm Ø 3 Charr./Fr.
02-101 1 2/3 mm Ø 5 Charr./Fr.
02-102 2 1/3 mm Ø 7 Charr./Fr.
02-103 2 2/3 mm Ø 8 Charr./Fr.
02-104 3 1/3 mm Ø 10 Charr./Fr.
02-105 4 mm Ø 12 Charr./Fr.
02-106 4 2/3 mm Ø 14 Charr./Fr.

Plester Suction Tubes 17 cm
02-107 2.0 mm Ø 6 Charr./Fr.
02-108 2.3 mm Ø 7 Charr./Fr.
02-109 2.5 mm Ø 8 Charr./Fr.
02-110 3.0 mm Ø 9 Charr./Fr.
02-111 3.3 mm Ø 10 Charr./Fr.
02-112 3.5 mm Ø 11 Charr./Fr.
02-113 4.5 mm Ø 12 Charr./Fr.
02-114 5.0 mm Ø 15 Charr./Fr.

Fergusson Suction Tubes 17 cm
02-115 2.0 mm Ø 6 Charr./Fr.
02-116 2.3 mm Ø 7 Charr./Fr.
02-117 2.5 mm Ø 8 Charr./Fr.
02-118 3.0 mm Ø 9 Charr./Fr.
02-119 3.3 mm Ø 10 Charr./Fr.
02-120 3.5 mm Ø 11 Charr./Fr.
02-121 4.5 mm Ø 12 Charr./Fr.
02-122 5.0 mm Ø 15 Charr./Fr.



FRAZIER
suction tubes
02-123 6 Fr.
02-124 7 Fr.
02-125 8 Fr.
02-126 9 Fr.
02-127 10 Fr.
02-128 11 Fr.
02-129 12 Fr.
02-130 13 Fr.
02-131 15 Fr.
19 cm

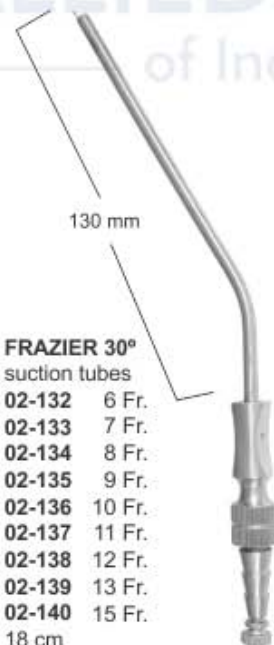

FRAZIER 30°
suction tubes
02-132 6 Fr.
02-133 7 Fr.
02-134 8 Fr.
02-135 9 Fr.
02-136 10 Fr.
02-137 11 Fr.
02-138 12 Fr.
02-139 13 Fr.
02-140 15 Fr.
18 cm

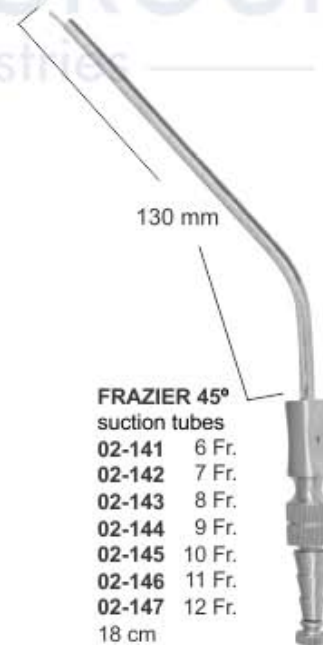

FRAZIER 45°
suction tubes
02-141 6 Fr.
02-142 7 Fr.
02-143 8 Fr.
02-144 9 Fr.
02-145 10 Fr.
02-146 11 Fr.
02-147 12 Fr.
18 cm

Cannula

02-148 ○ 6fr
02-149 ○ 7fr
02-150 ○ 8fr
02-151 ○ 9fr
02-152 ○ 10fr
02-153 ○ 11fr
02-154 ○ 12fr
02-155 ○ 13fr
02-156 ○ 14fr



SUCTION AND IRRIGATION CANNULAS

Saug-und Spülkanülen | Canulas para aspiracion y lavado
 Canules pour aspiration | Cannule per aspirazione e lavaggio



Luer
02-157
 Suction Tube working
 length 110 mm



Nasal Suction Tubes
02-158 Ø 4.5 mm
02-159 Ø 5.5 mm
 17.5 cm



**Eicken
 Suction &
 Irrigation Cannula**
02-160 2.5 mm Ø
02-161 3.0 mm Ø
 Slightly curved



**Eicken
 Suction &
 Irrigation Cannula**
02-162 2.5 mm Ø
02-163 3.0 mm Ø
 Strongly curved



**Tonsil Needle
 Suction &
 Irrigation Cannula**
02-164 0.8 mm Ø
 Straight



**Tonsil Needle
 Suction &
 Irrigation Cannula**
02-165 0.8 mm Ø
 Curved



**Septum Needle
 Suction &
 Irrigation Cannula**
02-166 0.8 mm Ø
 bayonet



**Septum Needle
 Suction &
 Irrigation Cannula**
02-167 0.8 mm Ø
 angled on flat



**Luer-Lock Suction &
 Irrigation Cannula**
02-168 3.0 mm Ø



**Luer-Lock Suction &
 Irrigation Cannula**
02-169 2.5 mm Ø

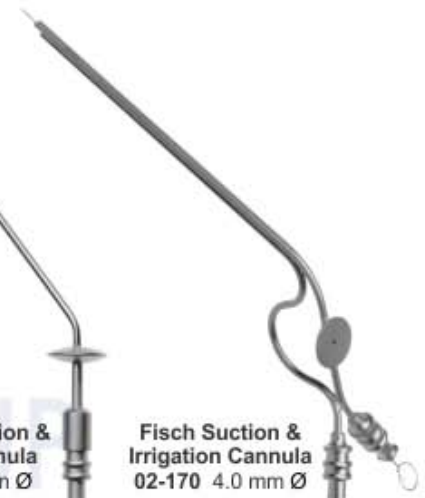

**Fisch Suction &
 Irrigation Cannula**
02-170 4.0 mm Ø

Probe, Double Ended
 1.0 mm Ø
02-171 11.5cm
02-172 13.0cm
02-173 14.5cm
02-174 16.0cm
02-175 18.0cm
02-176 20.0cm
02-177 25.0cm

Probe, Double Ended
 1.5 mm Ø
02-178 11.5cm
02-179 13.0cm
02-180 14.5cm
02-181 16.0cm
02-182 18.0cm
02-183 20.0cm
02-184 25.0cm

Probe, Double Ended
 2.0 mm Ø
02-185 11.5cm
02-186 13.0cm
02-187 14.5cm
02-188 16.0cm
02-189 18.0cm
02-190 20.0cm
02-191 25.0cm



Probe With Eye
 2.0mm Ø
02-192 11.5cm
02-193 13.0cm
02-194 14.5cm
02-195 16.0cm
02-196 18.0cm
02-197 20.0cm
02-198 25.0cm
 with eyelet



Probe
 2.0mm Ø
02-199 11.5cm
02-200 13.0cm
02-201 14.5cm
02-202 16.0cm
 myrtle-shaped



Hartmann, Eustachian Catheters
Fig. 1
02-203 2.0 mm Ø
02-204 2.5 mm Ø
02-205 3.0 mm Ø



Hartmann Eustachian Catheters
Fig. 2
02-206 2.0 mm Ø
02-207 2.5 mm Ø
02-208 3.0 mm Ø



Killian, Eustachian Catheters
02-209 16 cm 2.5 mm Ø
02-210 16 cm 3.0 mm Ø oval opening



Hartmann Eustachian Catheters
15cm



Trötsch Eustachian Catheters 15cm



02-217
Tube end piece for eustachian catheter



Zöllner, Suction Tube
02-223 0.7mm Ø complete with 1 slip-on cannula, 0.7mm Ø



Iowa, Suction Tube
02-224 0.7mm Ø 16cm



Rosen Suction Tube
X=80 mm
02-225 0.7mm Ø
02-226 0.9mm Ø
02-227 1.2mm Ø



ROSEN, Suction Tube
X=65 mm
02-228 0.7mm Ø
02-229 0.9mm Ø
02-230 1.2mm Ø



Magill Suction Tube
24.5cm
02-231 3.0mm Ø
02-232 3.5mm Ø
02-233 4.0mm Ø



Suction Tube, Guide Needle
19.5cm
02-234 2.2/3mmØ 8 Charr./Fr.
02-235 3.1/3mmØ 10 Charr./Fr.
02-236 4mmØ 12 Charr./Fr.
02-237 4 2/3mmØ 14 Charr./Fr.
02-238 5 1/3mmØ 16 Charr./Fr.
02-239 6mmØ 18 Charr./Fr.

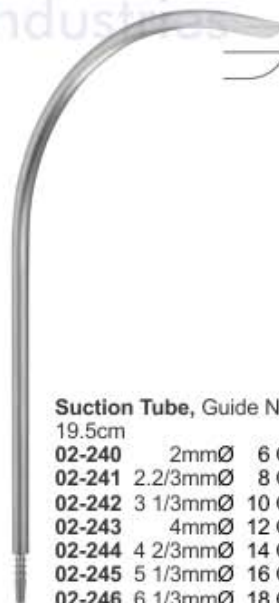

Suction Tube, Guide Needle
19.5cm
02-240 2mmØ 6 Charr./Fr.
02-241 2.2/3mmØ 8 Charr./Fr.
02-242 3 1/3mmØ 10 Charr./Fr.
02-243 4mmØ 12 Charr./Fr.
02-244 4 2/3mmØ 14 Charr./Fr.
02-245 5 1/3mmØ 16 Charr./Fr.
02-246 6 1/3mmØ 18 Charr./Fr.



Suction Tube, Guide Needle Lancet Tip 19.5cm
02-247 2.2/3mmØ 8 Charr./Fr.
02-248 3.1/3mmØ 10 Charr./Fr.
02-249 4mmØ 12 Charr./Fr.
02-250 4 2/3mmØ 14 Charr./Fr.
02-251 5 1/3mmØ 16 Charr./Fr.
02-252 6mmØ 18 Charr./Fr.

PROBES AND DIRECTORS

Sonden | Sondas y estiletos
 Sondes et stylets | Specilli e sonde

**Butterfly Grooved Director
 With Tongue Tie Plain End**

- 02-253 11.5cm
- 02-254 13.0cm
- 02-255 14.5cm
- 02-256 16.0cm
- 02-257 18.0cm
- 02-258 20.0cm



**Butterfly Grooved Director
 With Tongue Tie Plain End**

- 02-259 11.5cm
- 02-260 13.0cm
- 02-261 14.5cm
- 02-262 16.0cm
- 02-263 18.0cm
- 02-264 20.0cm



**Doyen
 Probes &
 Directors
 02-265
 14cm**



**Nélaton
 Probes &
 Directors
 02-266
 16cm**



**Directors
 02-267 13cm
 02-268 14.5cm
 02-269 16cm
 Larry Probe
 and Grooved
 Director,
 17.8 cm**



**Doyen
 02-270
 14.5cm**



**Nélaton
 02-271
 16cm**



**Director Probe
 End
 02-272 14cm
 Director with tip
 Diam. of tip
 3.3 mm**



**Brodie
 02-273 20cm
 Director with
 tip Diam. of
 tip 3.5 mm**



**Lockhart-
 Mummery
 02-274
 16.5cm**

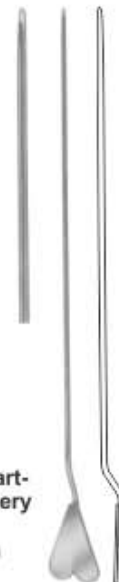

**Lockhart-
 Mummery
 02-275
 16.5cm**



**Lockhart-
 Mummery
 02-276
 16.5cm**

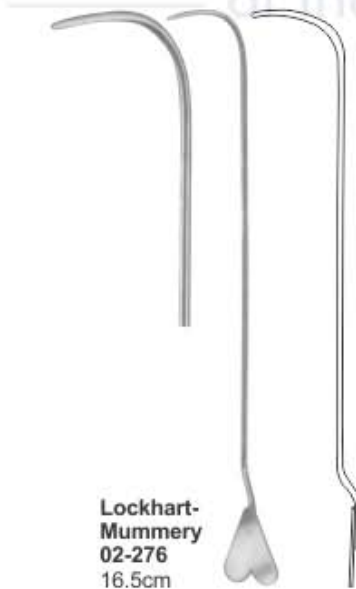

**Lockhart-
 Mummery
 02-277
 16.5cm**

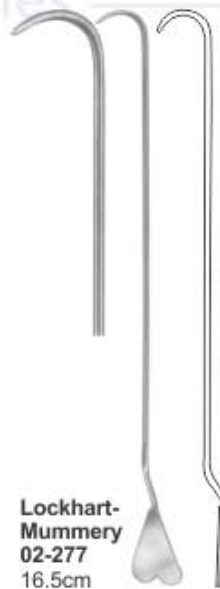

**Director
 with wire
 loop,
 malleable
 02-278
 19cm**



COTTON APPLICATORS



Jopson-Horne
Cotton Applicator
02-279 18cm



Fein Cotton
Applicator
02-280 28cm



Pelteson Cotton
Applicator
02-281 23cm



Barr Fistula Probe
02-282
with 20.3cm sterling shaft,
eye at tip, 29.2cm overall



Barr Crypt Hook
02-283
25.4cm short and
long hook ends



Buie Suction Tube
02-284
45 cm with finger
valve, 15 Fr. (5 mm)

Bowman Lacrimal Probes Double Ended, Sterling Silver



02-285
Bowman Probe,
000-0000



02-286
Bowman Probe,
00-0



02-287
Bowman Probe,
1-2



02-288
Bowman Probe,
3-4



02-289
Bowman Probe,
5-6



02-290
Bowman Probe,
7-8

William Lacrimal Probes Double Ended, Sterling Silver



02-291
William Probe,
000-0000



02-292
William Probe,
00-0



02-293
William Probe,
1-2



02-294
William Probe,
3-4



02-295
William Probe,
5-6



02-296
William Probe,
7-8

PROBES AND DIRECTORS

Sonden | Sondas y estiletas
Sondes et stylets | Specilli e sonde

								
Biolvar 02-297 15cm 02-298 18cm 02-299 20cm	Desjardim 02-300 18cm (Set 3 Pieces)	Probes With Eye 02-301 14.5cm 02-302 16.0cm 02-303 20.0cm	Myrtle Leaf Probe 02-304 14.5cm	Myrtle Leaf Probe 02-305 13.0cm 02-306 14.5cm 02-307 16.0cm 02-308 18.5cm 02-309 20.0cm	Probe 02-310	Wilder Lacrimal Dilator 02-311 10cm medium taper	02-312 19cm Double ended probe, malleable, diam, of tips 3 mm with hole	
								
02-313 25cm 02-314 30cm Double ended probes, tin, malleable, diam, of tips 3.5 mm with hole	02-315 40cm Double ended probes, tin, malleable, diam, of tips 4 mm with hole	02-316 1.5 mm 02-317 2.0 mm 02-318 2.5 mm 30cm	Clips Mayo 02-319 14cm	Stacke 02-320 10cm	Killian 02-321 16.5cm	02-322 16.5cm	Seiffert 02-323 18cm	
								
Modell Piccolo 02-324 11cm Round Serrated	Modell Piccolo 02-325 11cm Triangular Serrated end	Farrell 02-326 11cm Round Serrated end	Lathbury-Farrel 02-327 11cm Triangular Serrated end	Spatula 02-328 14.5cm	Spatula 02-329 14.5cm			